



US00D610147S

(12) **United States Design Patent**
Kuroda et al.

(10) **Patent No.:** **US D610,147 S**

(45) **Date of Patent:** **** Feb. 16, 2010**

(54) **SCANNER**

(75) Inventors: **Hiroyuki Kuroda**, Kahoku (JP);
Minoru Sugitani, Kahoku (JP); **Toshiki Satoji**, Milan (IT)

(73) Assignee: **PFU Limited**, Ishikawa (JP)

(**) Term: **14 Years**

(21) Appl. No.: **29/311,395**

(22) Filed: **Mar. 5, 2009**

(30) **Foreign Application Priority Data**

Sep. 5, 2008 (JP) 2008-022977

(51) **LOC (9) Cl.** **14-02**

(52) **U.S. Cl.** **D14/422**

(58) **Field of Classification Search** D14/420-425,
D14/462-470, 389, 125, 399; D18/50, 54,
D18/55, 53, 36-39, 14, 18-21, 49, 52, 51,
D18/54.4; 358/400, 401, 448, 474, 486-488,
358/496; 382/312, 317, 321, 315; 400/613,
400/613.1-613.4, 690.1-690.4, 691-694,
400/88, 175; 399/107, 379, 380, 211, 212;
235/462.11, 462.41, 472.01, 470, 462.43;
361/680, 681

See application file for complete search history.

(56) **References Cited**

U.S. PATENT DOCUMENTS

D210,218 S * 2/1968 Williams D14/385
D215,568 S * 10/1969 Kellogg D15/146
D264,846 S * 6/1982 Taguchi D14/462
D268,111 S * 3/1983 Clemens D18/54
D277,133 S * 1/1985 Houlihan D24/165
D279,783 S * 7/1985 Jordan et al. D18/55
4,561,925 A * 12/1985 Skerjanec et al. 53/374.8
D285,965 S * 9/1986 Nishibori et al. D24/165
D286,437 S * 10/1986 Nishibori D24/165
D292,976 S * 12/1987 Kando D14/466
D295,186 S * 4/1988 Hadtke D18/54
D297,051 S * 8/1988 Kawamura D24/165

4,806,036 A * 2/1989 Ward et al. 400/691
D304,722 S * 11/1989 Hashimoto et al. D14/467
D304,724 S * 11/1989 Hashimoto et al. D14/467
4,976,559 A * 12/1990 Inagaki 400/691
D315,360 S * 3/1991 Tokuda et al. D18/54
D315,361 S * 3/1991 Kojima et al. D18/55
D318,066 S * 7/1991 Moro D18/54
D324,395 S * 3/1992 Dubson D18/54
D326,678 S * 6/1992 Uchibori et al. D18/55
D331,774 S * 12/1992 Saeki D18/55
D337,608 S * 7/1993 Miyamoto D18/55
D343,636 S * 1/1994 Horie et al. D18/55
D348,054 S * 6/1994 Minasian et al. D14/425
D350,075 S * 8/1994 Reeder D10/94
D369,181 S * 4/1996 Kobayashi D18/55
D389,178 S * 1/1998 Chow et al. D18/50
D390,258 S * 2/1998 Kawahara et al. D18/55

(Continued)

Primary Examiner—Susan Moon Lee

(74) *Attorney, Agent, or Firm*—Staas & Halsey LLP

(57) **CLAIM**

The ornamental design for a scanner, as shown and described.

DESCRIPTION

FIG. 1 is a front perspective view of a scanner showing our new design;

FIG. 2 is a front view thereof;

FIG. 3 is a rear view thereof;

FIG. 4 is a right side view thereof;

FIG. 5 is a top plan view thereof;

FIG. 6 is a bottom plan view thereof;

FIG. 7 is a front perspective view of the scanner with the top cover open; and,

FIG. 8 is a front perspective view thereof with the top cover and lower catch tray in an open position.

The portions depicted in broken line are not claimed.

1 Claim, 4 Drawing Sheets

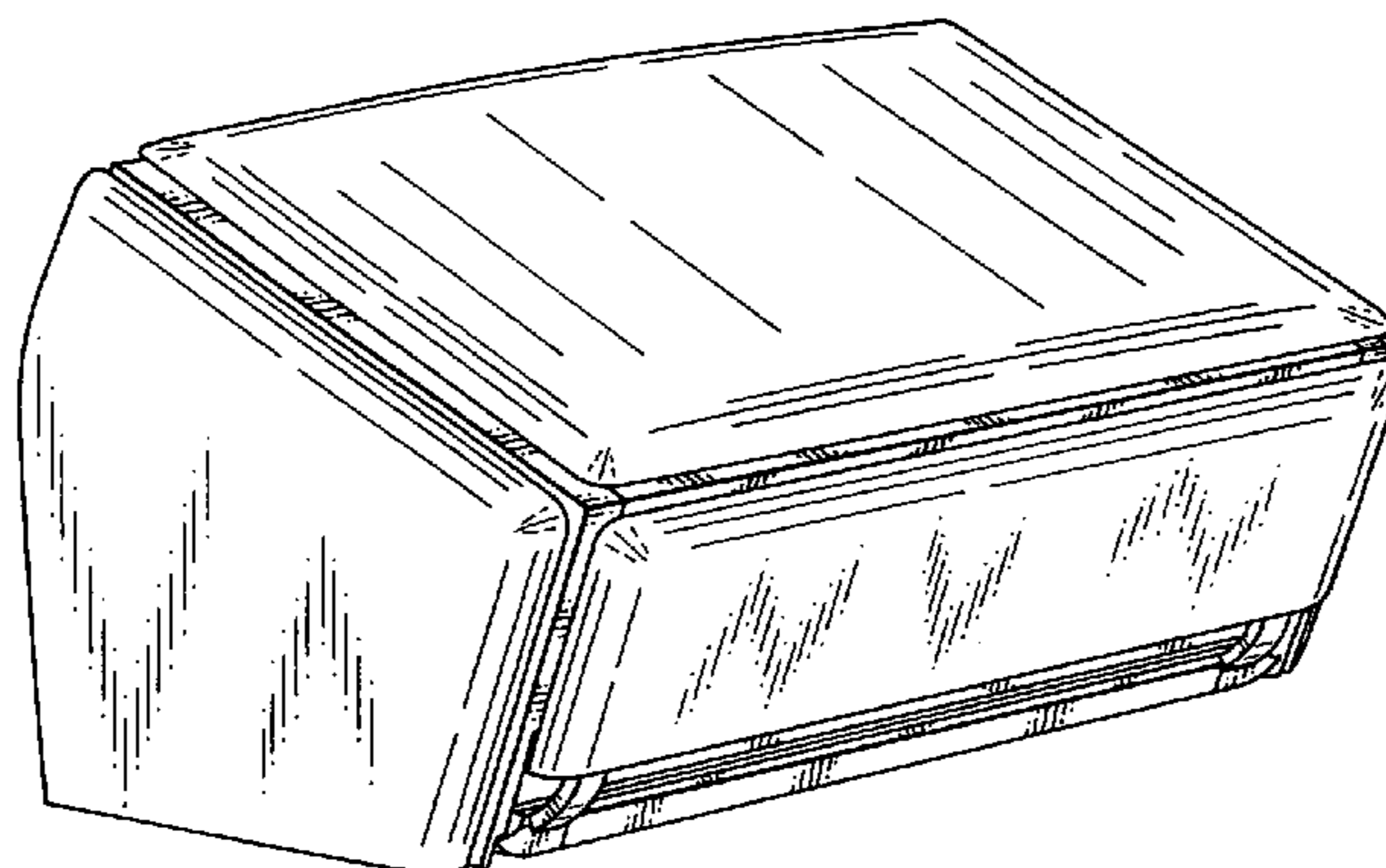

US D610,147 S

Page 2

U.S. PATENT DOCUMENTS

D399,524	S *	10/1998	Nakajima	D18/50
D401,271	S *	11/1998	Nakajima	D18/55
D401,965	S *	12/1998	Pangburn	D18/55
5,893,822	A *	4/1999	Deni et al.	53/512
D414,508	S *	9/1999	Pangburn	D18/55
D419,591	S *	1/2000	Pangburn	D18/55
D419,973	S *	2/2000	Ueda	D14/434
D420,663	S *	2/2000	Goldenberg et al.	D14/138 AB
D422,570	S *	4/2000	Kobayashi	D14/509
D424,099	S *	5/2000	Pangburn	D18/50
D432,565	S *	10/2000	Gassett et al.	D18/55
D433,442	S *	11/2000	Clark, III	D18/55
D435,266	S *	12/2000	Sekine et al.	D18/55
D437,414	S *	2/2001	Kern et al.	D24/165
D438,894	S *	3/2001	Bishop et al.	D18/55
D438,895	S *	3/2001	Pangburn	D18/55
D439,607	S *	3/2001	Inoue et al.	D18/54
6,231,043	B1 *	5/2001	James et al.	271/209
D443,878	S *	6/2001	Sakata et al.	D14/422
D444,813	S *	7/2001	Quijano	D18/55
D445,451	S *	7/2001	Clark et al.	D18/55
D446,306	S *	8/2001	Ochi et al.	D24/186
D454,583	S *	3/2002	Whitby et al.	D18/50
D463,485	S *	9/2002	Yoshida et al.	D18/50
D466,917	S *	12/2002	Liu	D18/36
D466,920	S *	12/2002	Kawahara et al.	D18/50
D474,806	S *	5/2003	Yamano et al.	D18/55
D475,052	S *	5/2003	Chujou et al.	D14/422
6,568,674	B2 *	5/2003	Matsuda	271/274
D483,059	S *	12/2003	Goh et al.	D18/50
6,707,584	B1 *	3/2004	Morita	358/498
D497,940	S *	11/2004	Hwang et al.	D18/50
D498,786	S *	11/2004	Suzuki et al.	D18/55
D499,759	S *	12/2004	Kobayashi et al.	D18/55
D518,826	S *	4/2006	Chujou et al.	D14/422
7,029,113	B2 *	4/2006	Hwang	347/108
D523,469	S *	6/2006	Hwang et al.	D18/50
7,134,259	B2 *	11/2006	Huang	53/512
D533,897	S *	12/2006	Workman et al.	D18/34.3
D536,370	S *	2/2007	Smolenski et al.	D18/50
D549,705	S *	8/2007	Sugitani et al.	D14/422
7,265,869	B2 *	9/2007	Silverbrook et al.	358/1.3
7,290,952	B2 *	11/2007	Kagami	400/693
D563,413	S *	3/2008	Kuroda et al.	D14/422
D571,370	S *	6/2008	Sugitani et al.	D14/422
D571,807	S *	6/2008	Ogawa	D14/422
7,431,447	B2 *	10/2008	Jensen	347/108
D579,972	S *	11/2008	Meda et al.	D18/50
D583,060	S *	12/2008	Kitamura et al.	D24/165
D601,259	S *	9/2009	Guthrie et al.	D24/169
2003/0030712	A1 *	2/2003	Kawaguchi et al.	347/104
2003/0110741	A1 *	6/2003	Wang	53/512
2004/0207144	A1 *	10/2004	Kanome et al.	271/9.01
2005/0050856	A1 *	3/2005	Baptista	53/434

* cited by examiner

Fig. 1

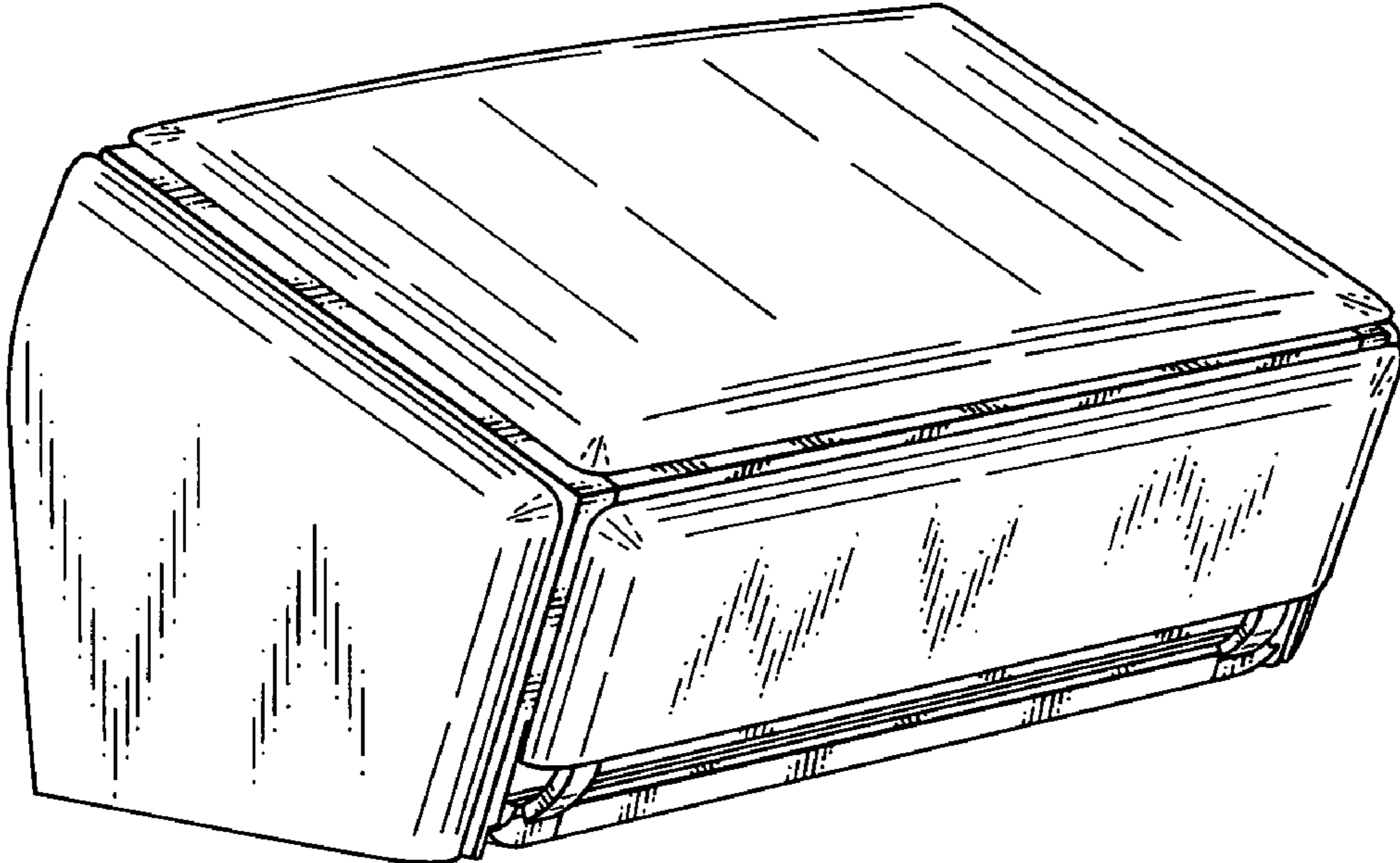

Fig. 2

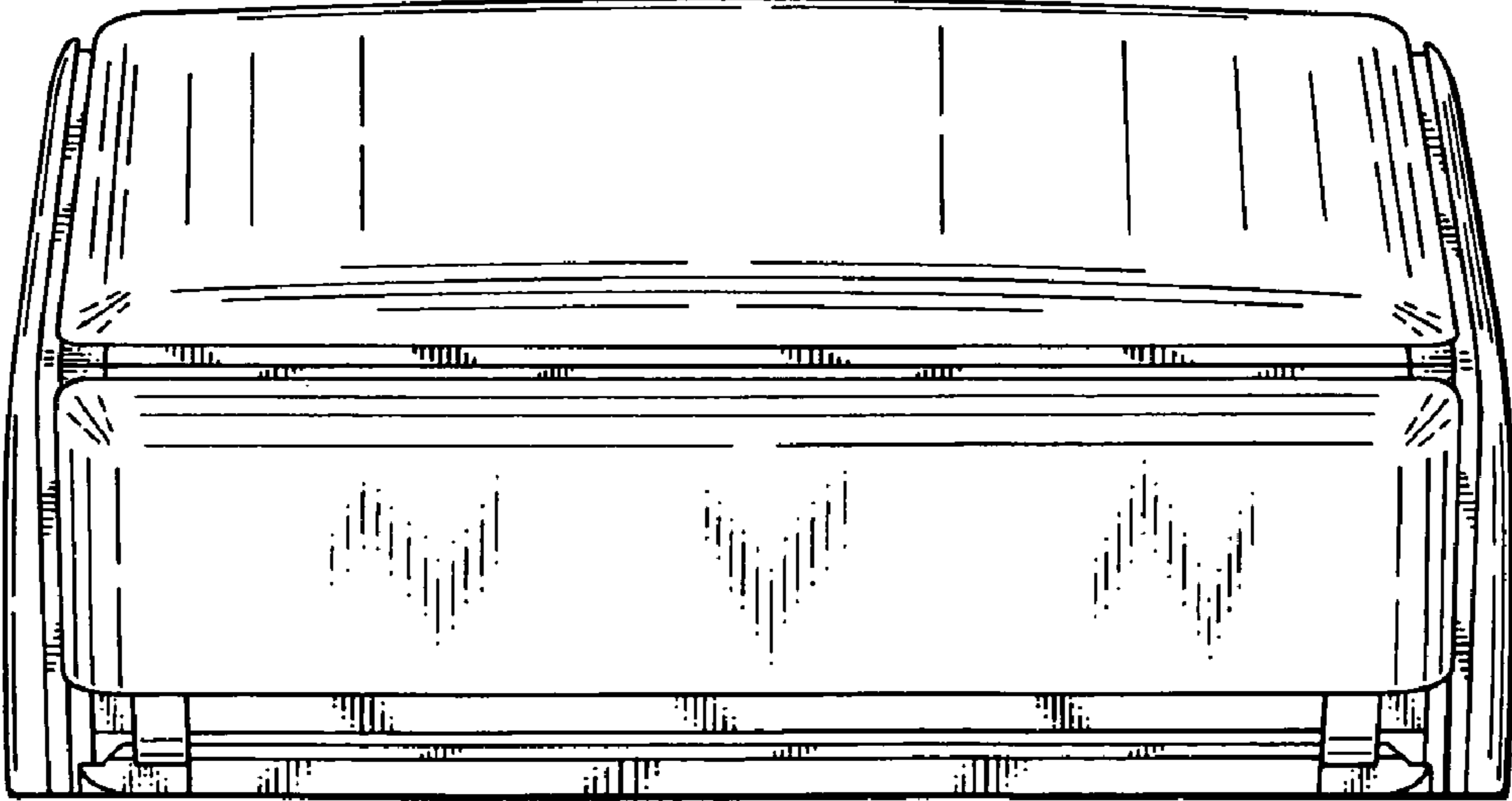

Fig. 3

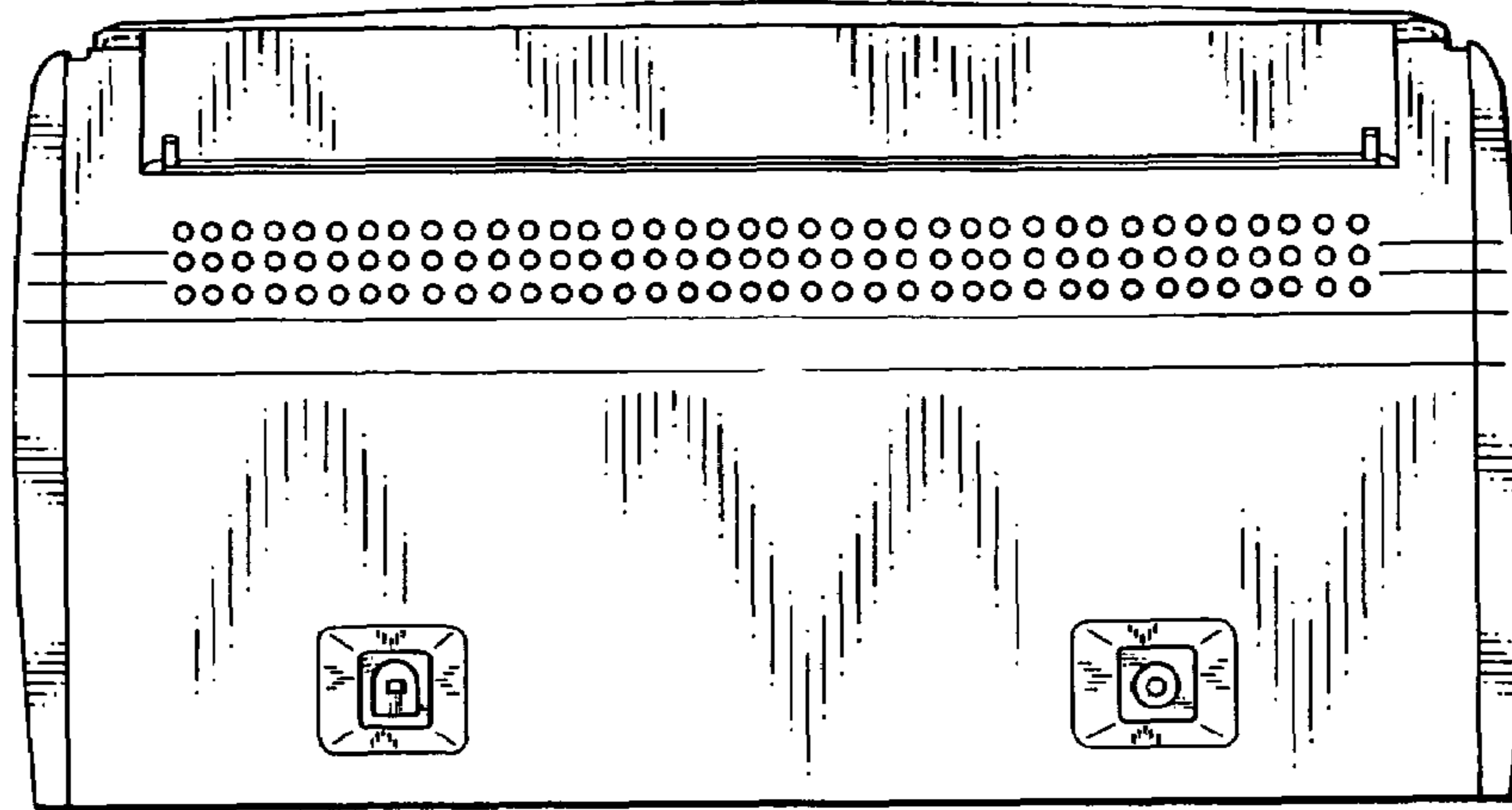

Fig. 4

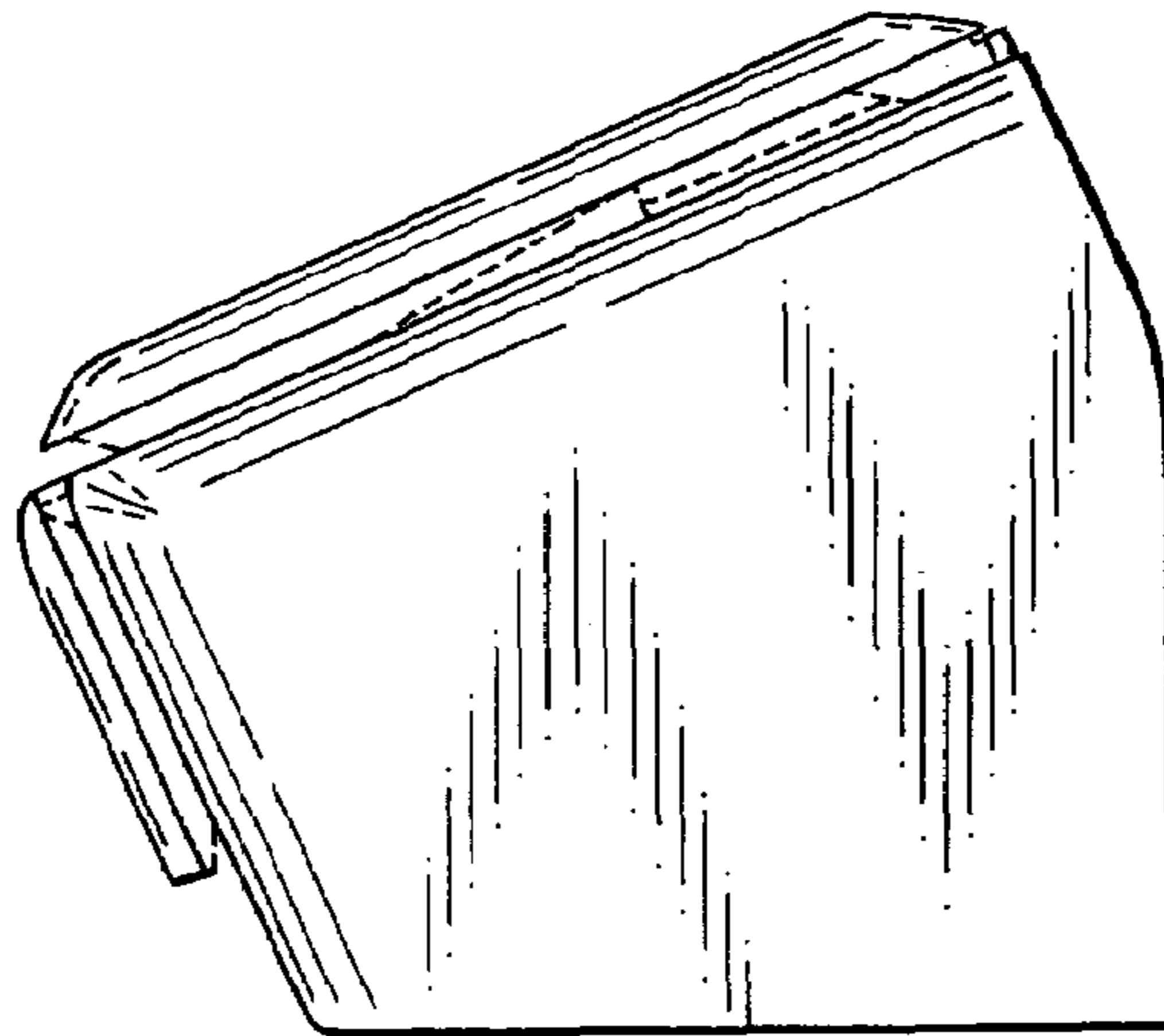

Fig. 5

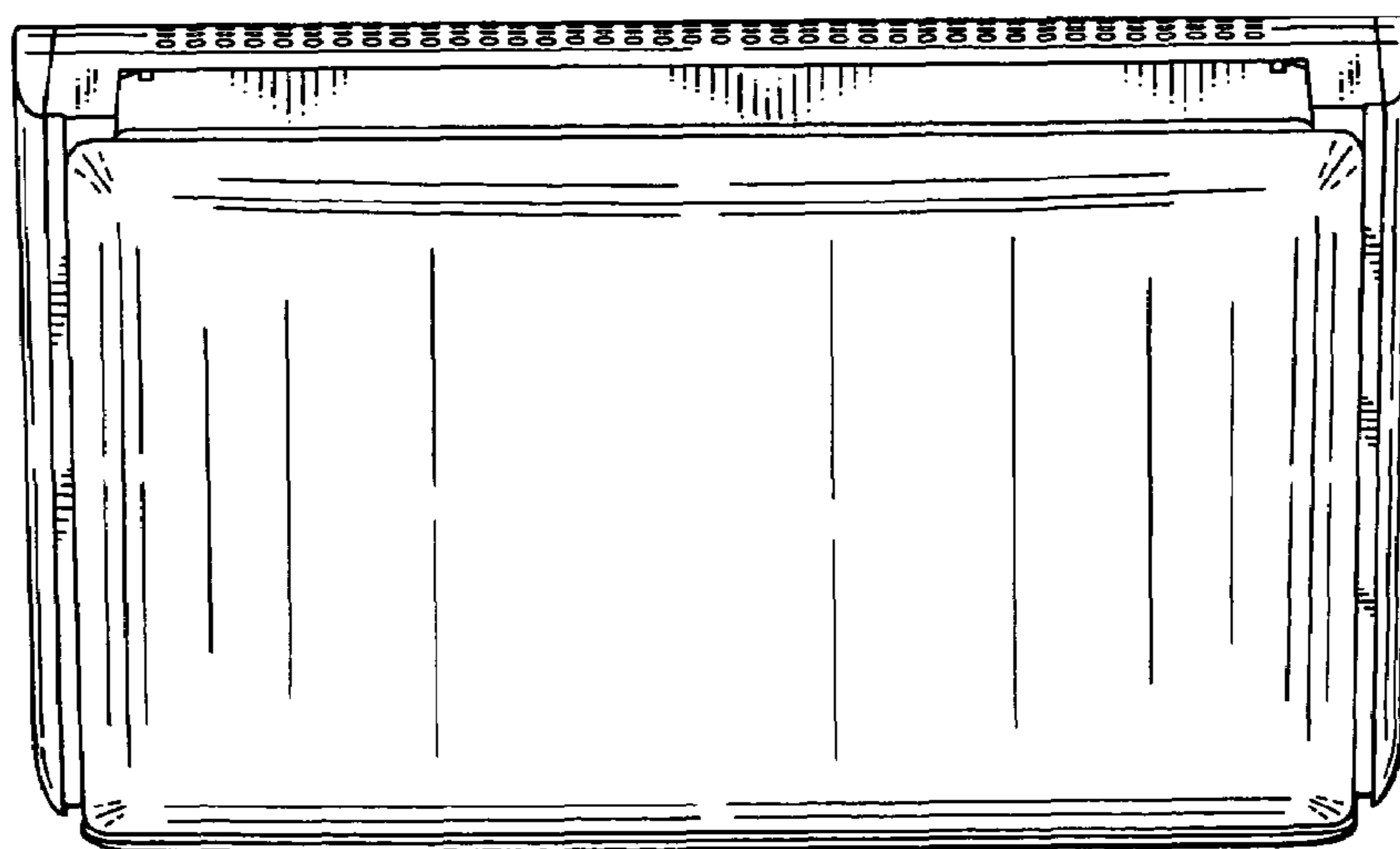

Fig.6

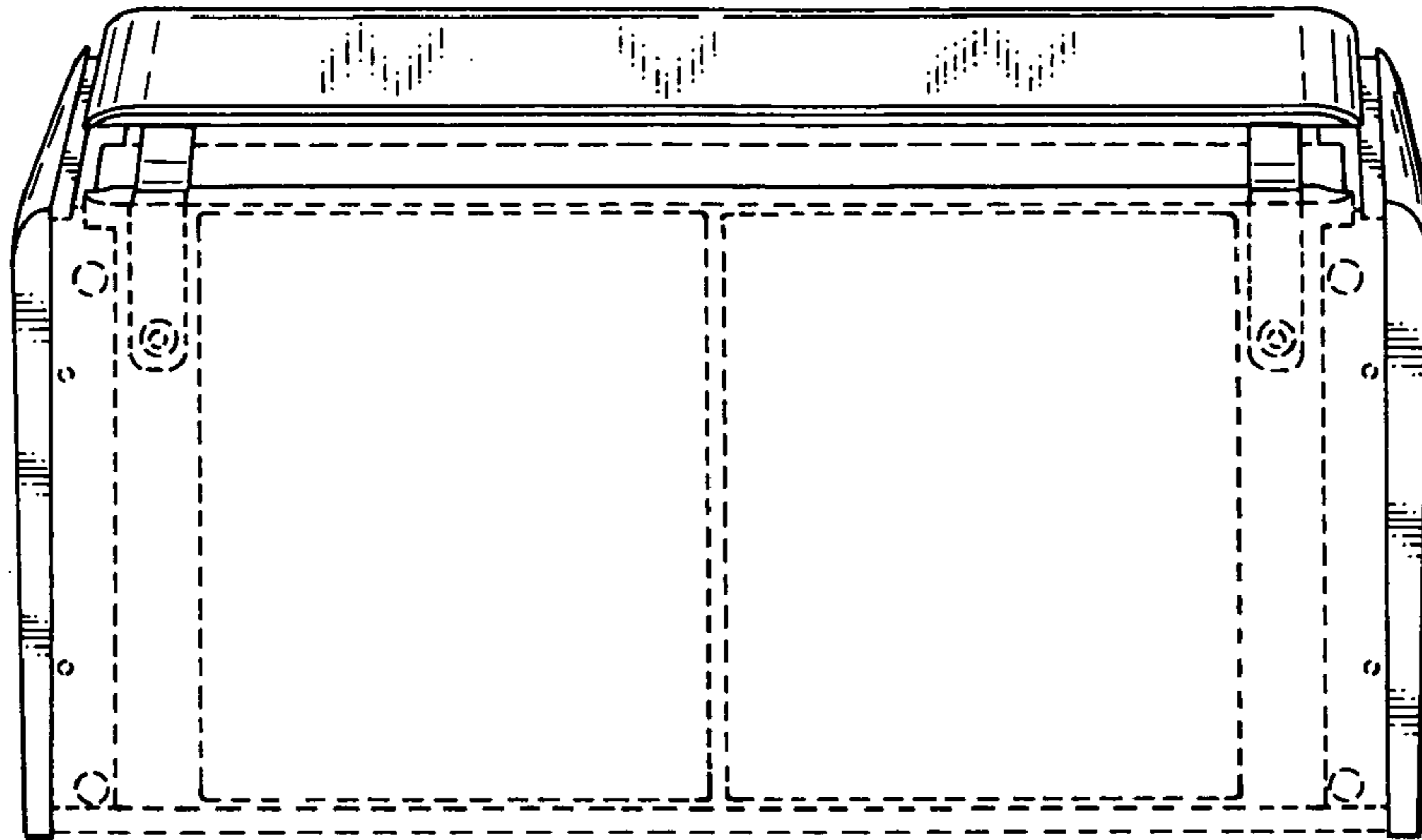

Fig.7

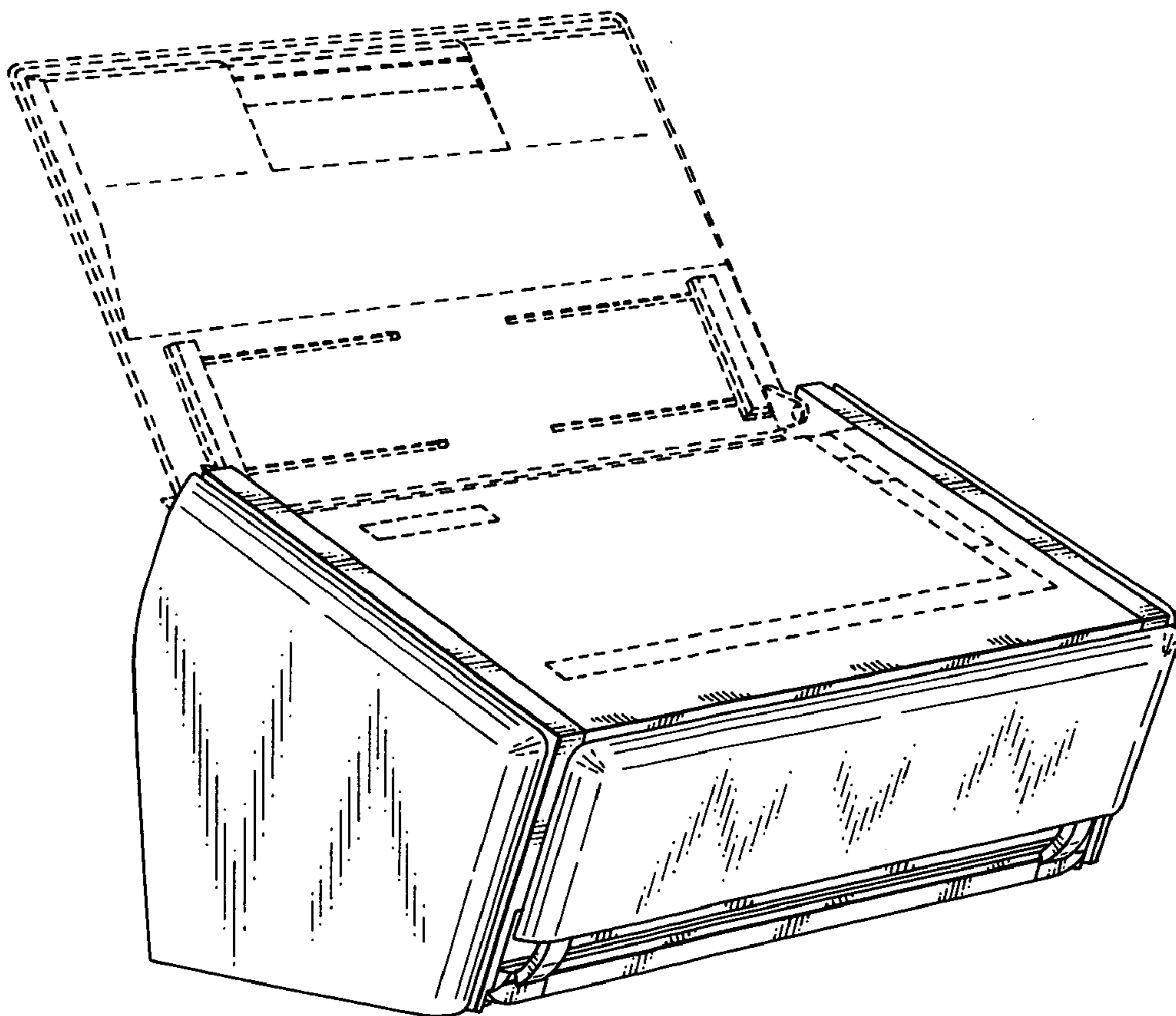

Fig.8

