



US00D610044S

(12) **United States Design Patent**
Sugimoto

(10) **Patent No.:** **US D610,044 S**

(45) **Date of Patent:** **** Feb. 16, 2010**

(54) **MOTORCYCLE**

D572,629 S * 7/2008 Kawagishi D12/110

(75) Inventor: **Hideo Sugimoto**, Hamamatsu (JP)

* cited by examiner

(73) Assignee: **Suzuki Motor Corporation**,
Hamamatsu-shi, Shizuoka Prefecture
(JP)

Primary Examiner—Philip S Hyder
Assistant Examiner—Linda G. Brooks

(74) *Attorney, Agent, or Firm*—Dana M. Gordon; Foley Hoag
LLP

(**) Term: **14 Years**

(57) **CLAIM**

(21) Appl. No.: **29/306,866**

The ornamental design for a motorcycle, as shown and
described.

(22) Filed: **Apr. 17, 2008**

(30) **Foreign Application Priority Data**

DESCRIPTION

Oct. 22, 2007 (JP) 2007-028960

FIG. 1 is a front view of a motorcycle showing my new
design;

(51) **LOC (9) Cl.** **12-11**

FIG. 2 is a front perspective view of the right side thereof;

(52) **U.S. Cl.** **D12/110**

FIG. 3 is a right side view thereof;

(58) **Field of Classification Search** D12/110;
180/219

FIG. 4 is a rear perspective view of the right side thereof;

See application file for complete search history.

FIG. 5 is a rear view thereof;

(56) **References Cited**

FIG. 6 is a rear perspective view of the left side thereof;

U.S. PATENT DOCUMENTS

FIG. 7 is a left side view thereof;

D394,027 S * 5/1998 Ban et al. D12/110

FIG. 8 is a front perspective of the left side thereof; and,

D395,621 S * 6/1998 Nishino D12/110

FIG. 9 is a top view thereof.

D439,868 S * 4/2001 Sugimoto D12/110

The portions of the motorcycle shown in broken lines form no
part of the claimed design.

D440,189 S * 4/2001 Ban et al. D12/110

1 Claim, 9 Drawing Sheets

D470,799 S * 2/2003 Yamaguchi et al. D12/110

D525,919 S * 8/2006 Sugimoto D12/110

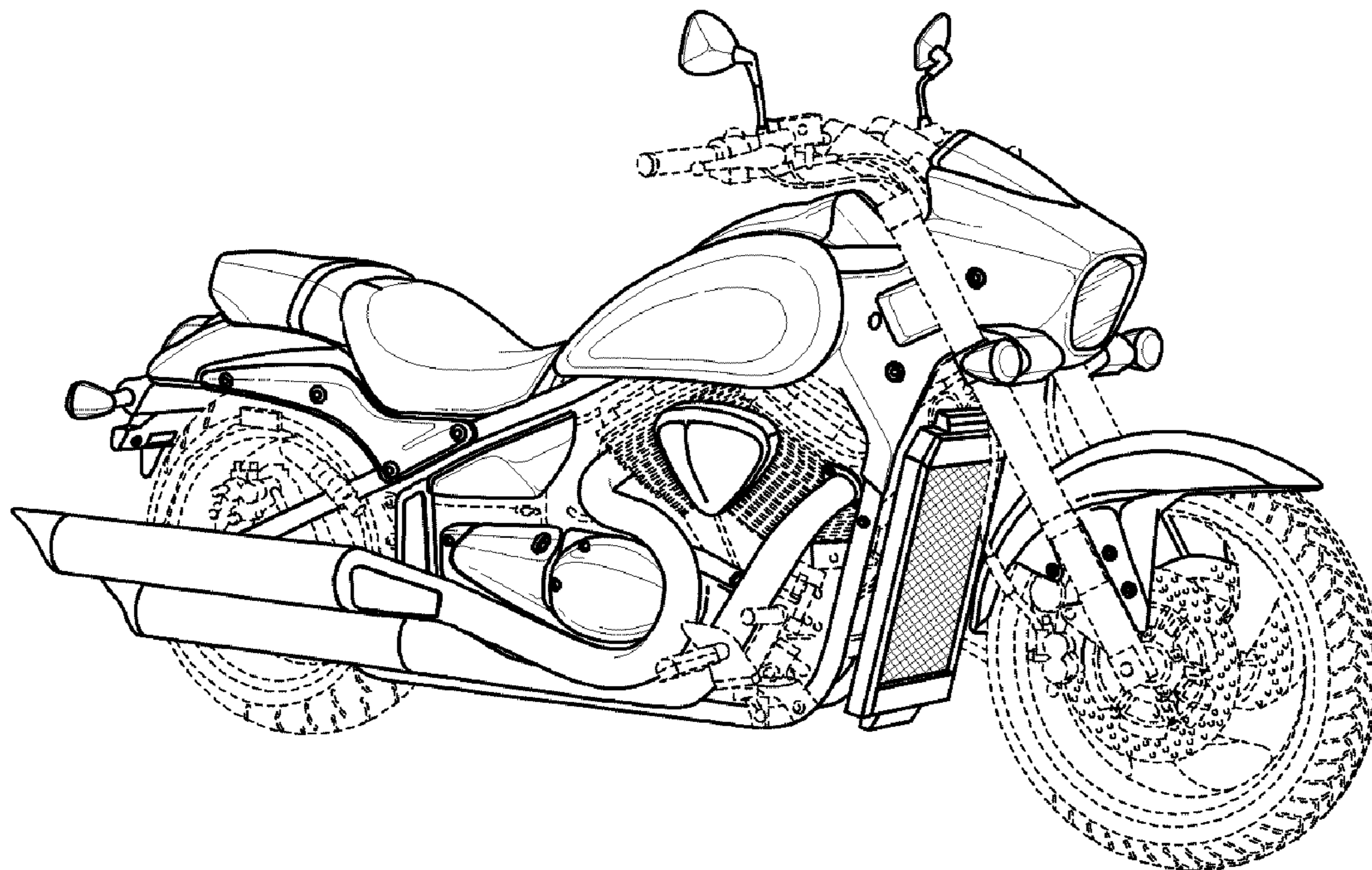

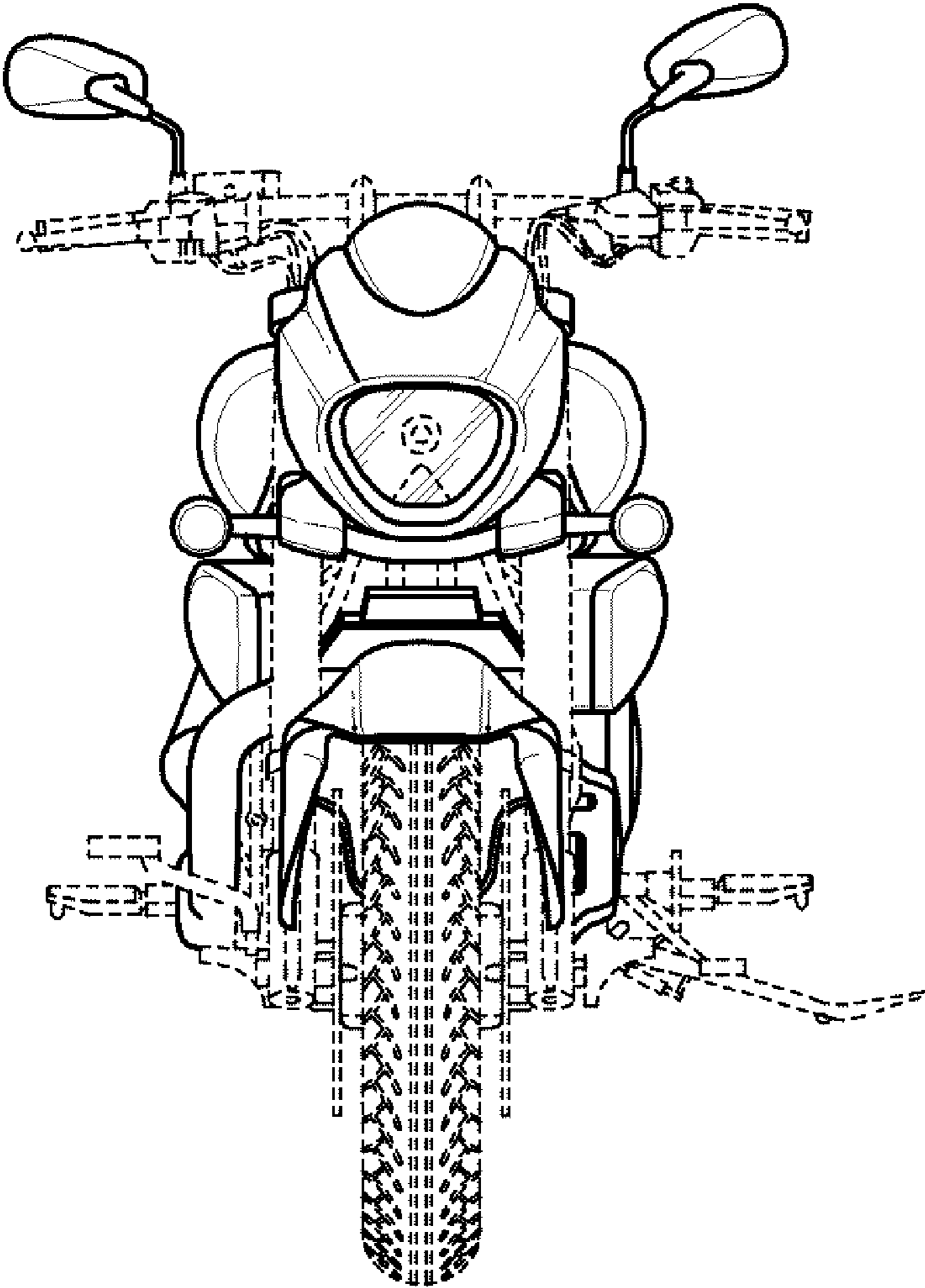

Fig. 1

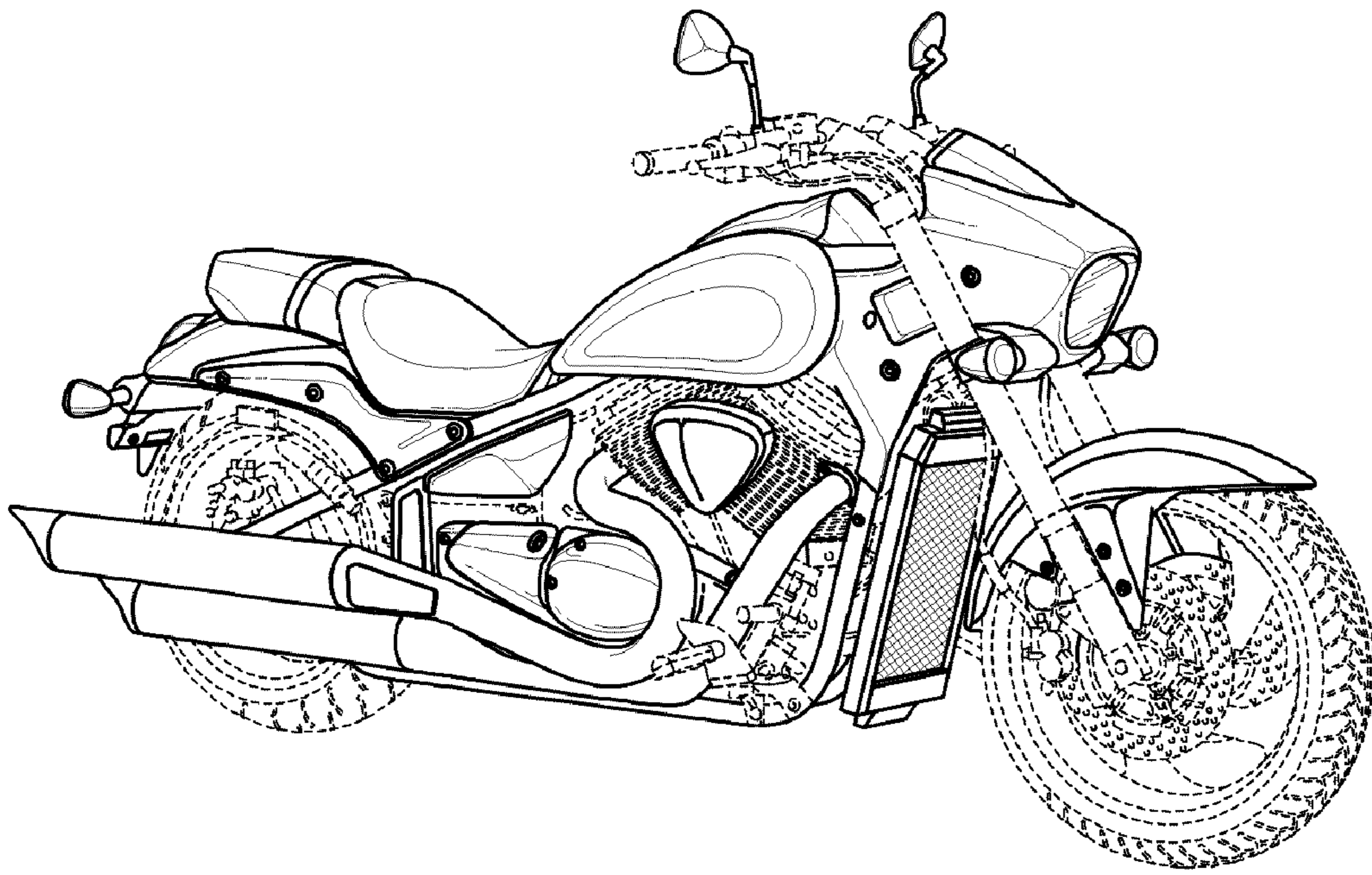

Fig. 2

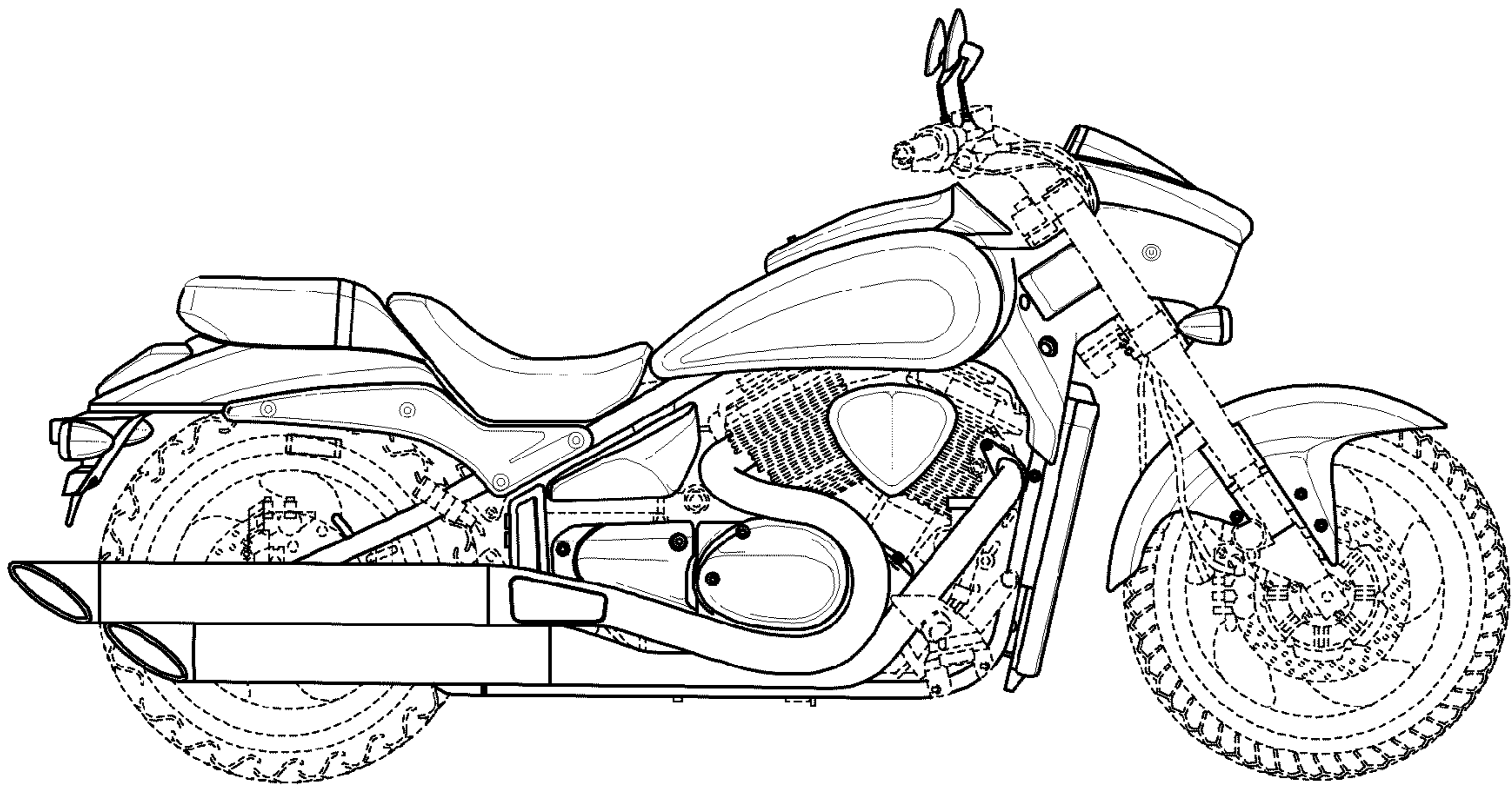

Fig. 3

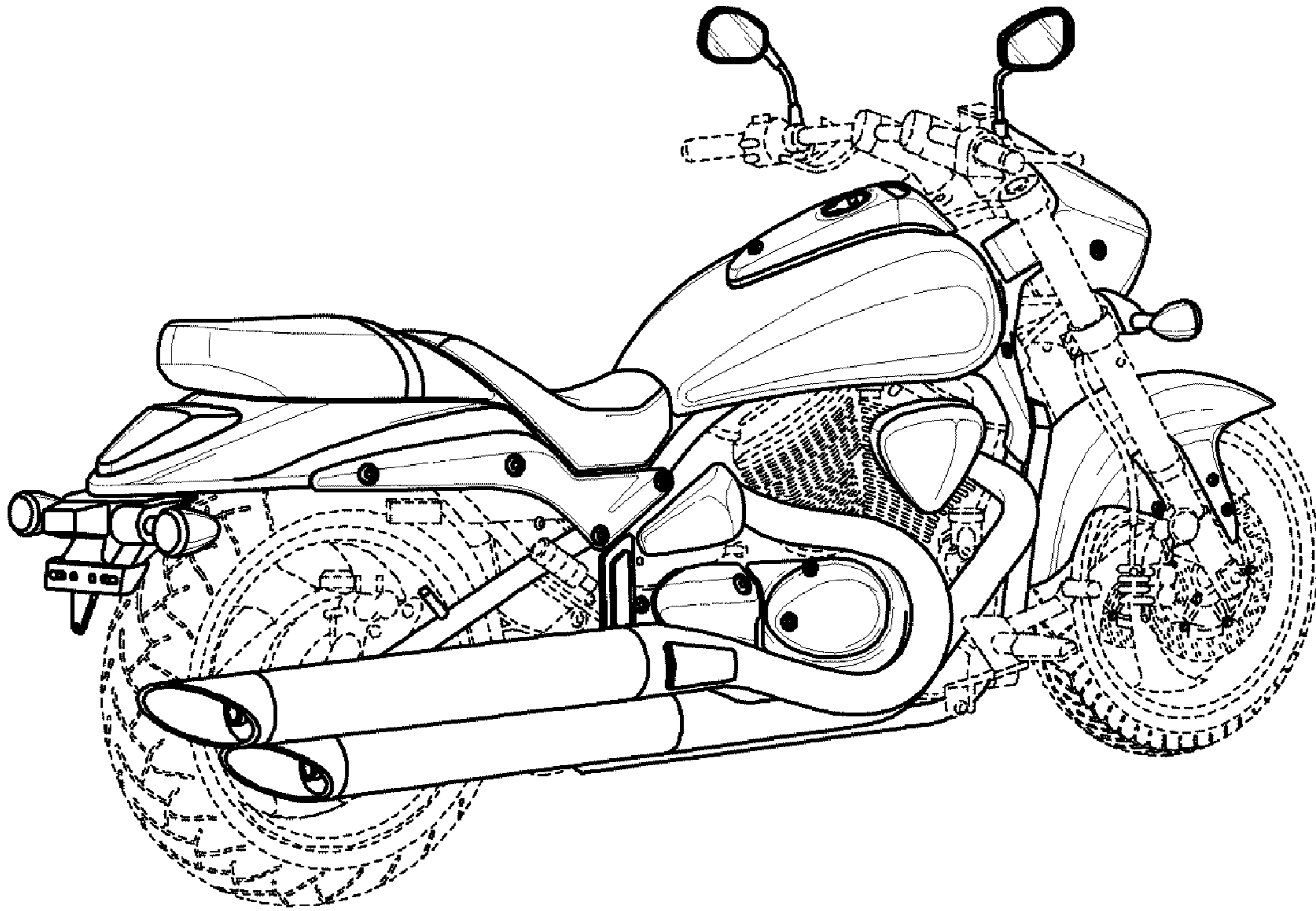

Fig. 4

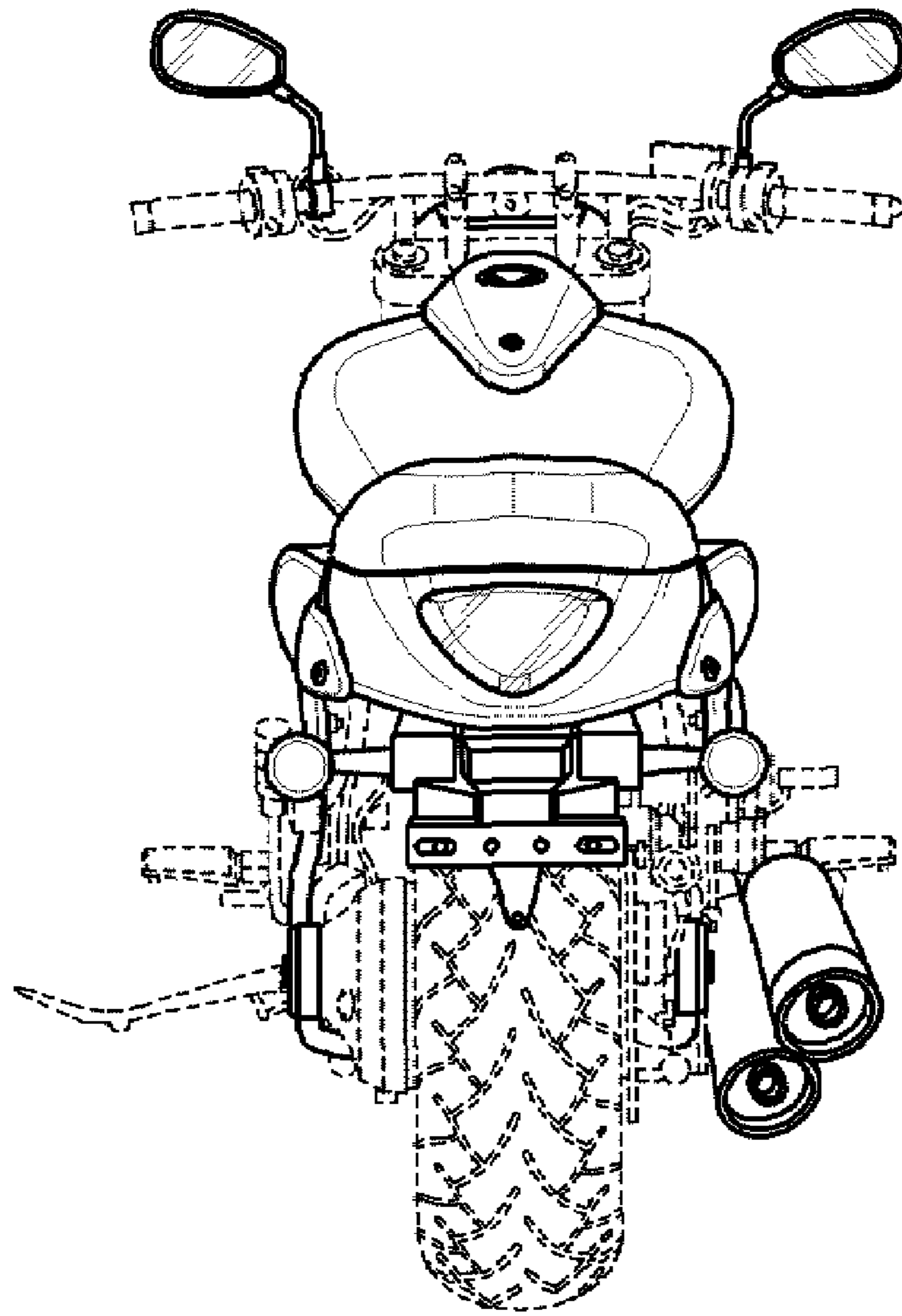

Fig. 5

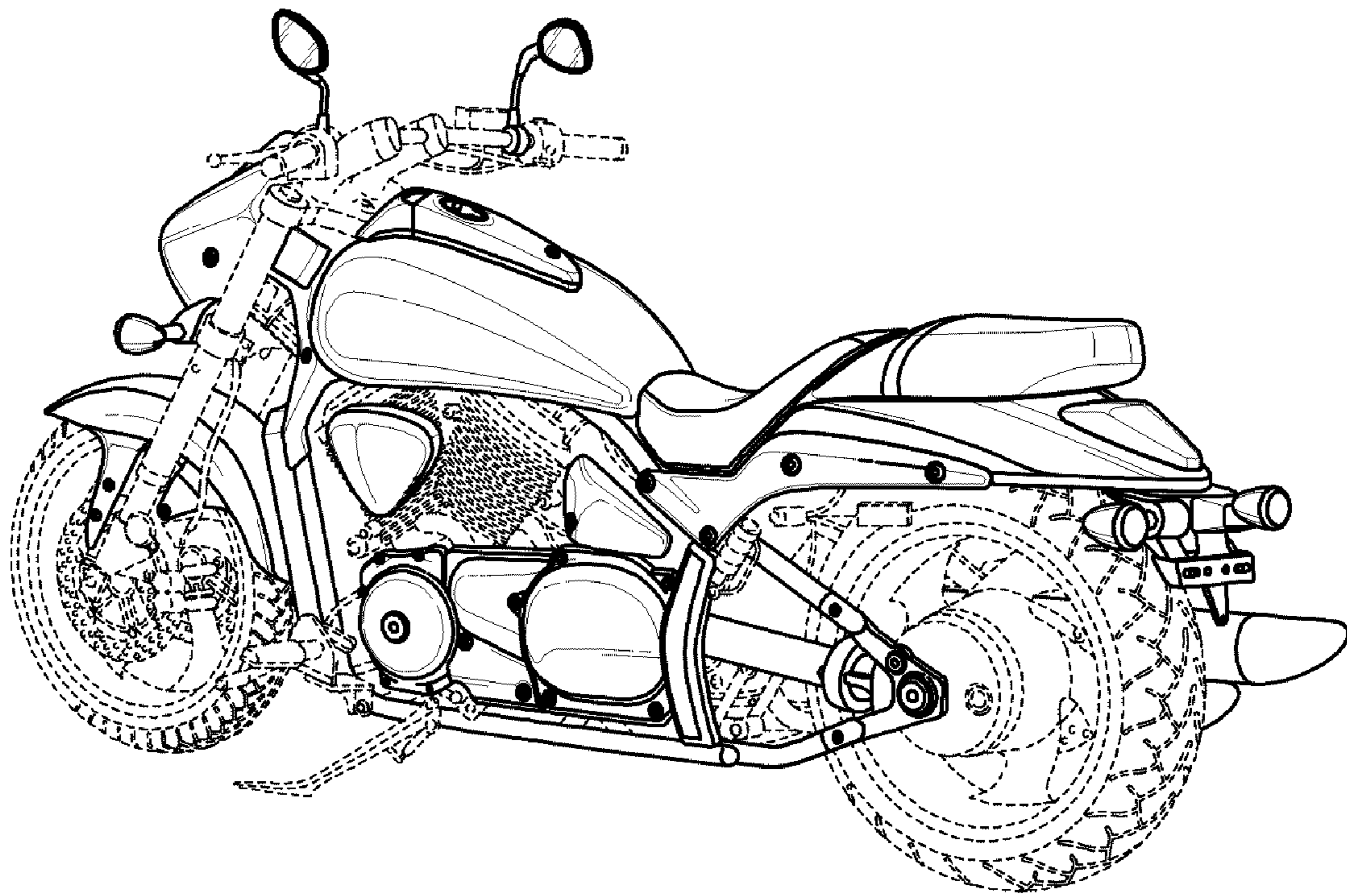

Fig. 6

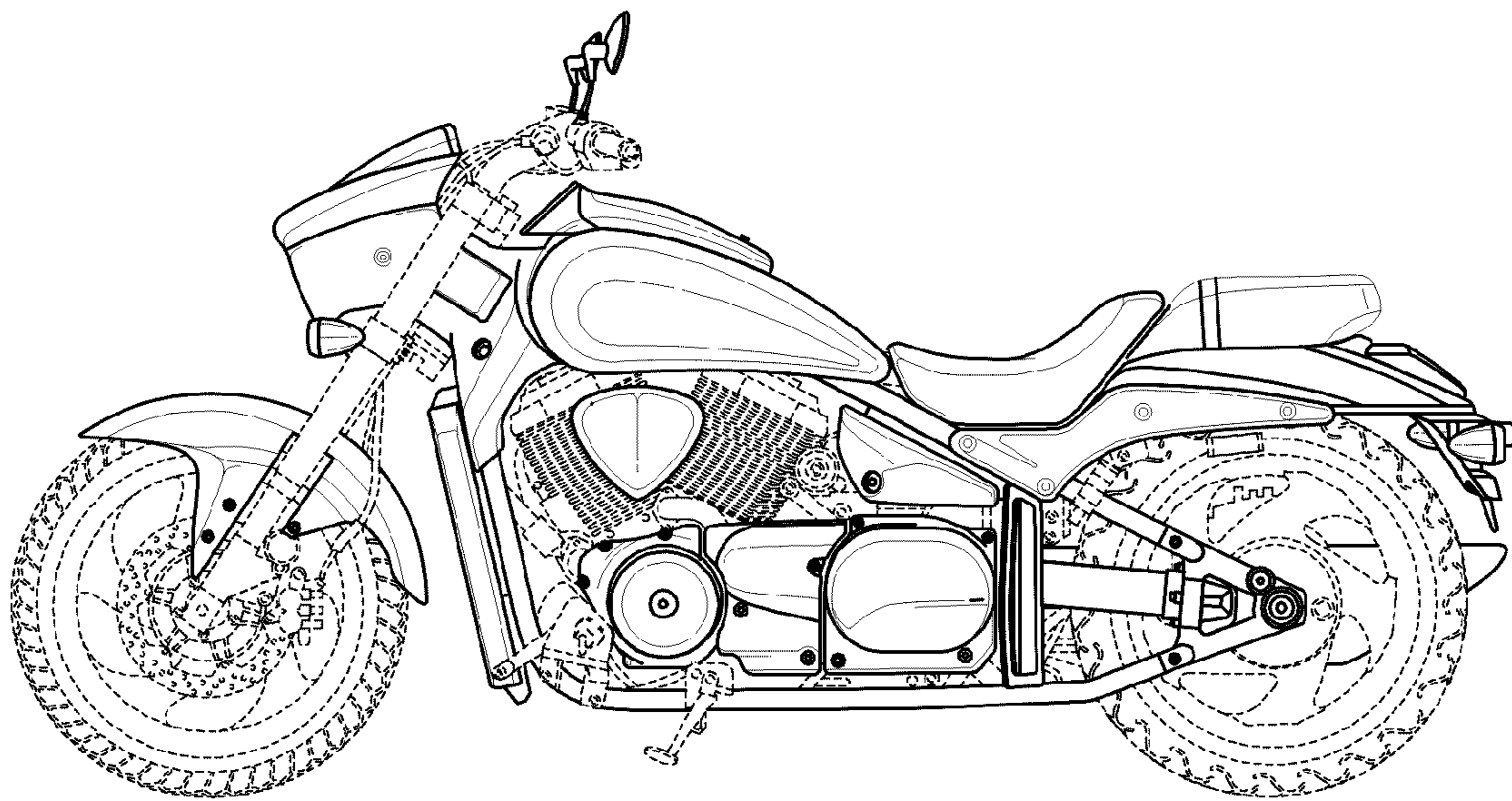

Fig. 7

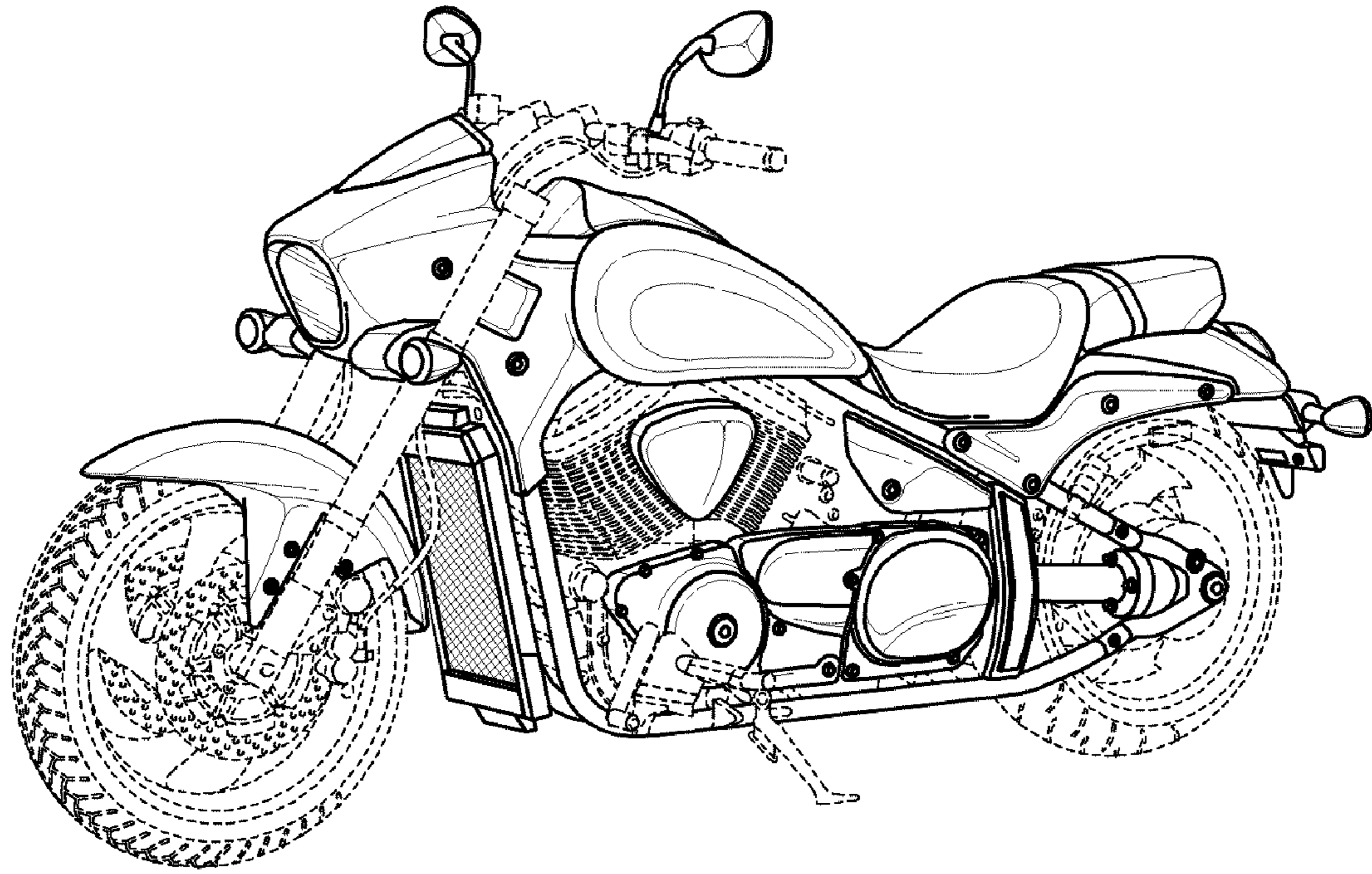

Fig. 8

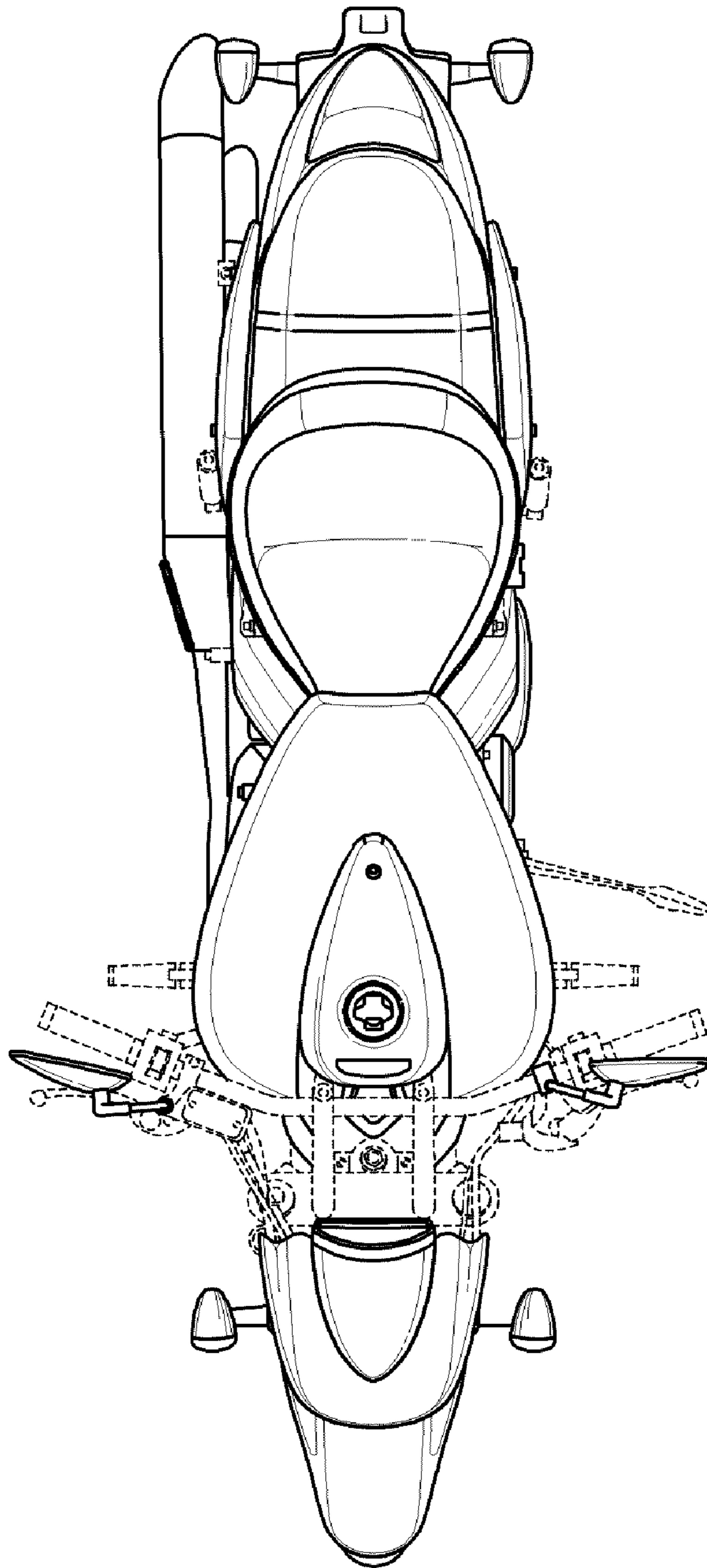

Fig. 9