



US00D610043S

(12) **United States Design Patent**
Bauer et al.

(10) **Patent No.:** **US D610,043 S**
(45) **Date of Patent:** **** Feb. 16, 2010**

(54) **VEHICLE, TOY REPLICA AND/OR OTHER REPLICAS**

(75) Inventors: **Karlheinz Bauer**, Esslingen (DE);
Mark Fetherston, Stuttgart (DE);
Hans-Dieter Futschik, Gechingen (DE);
Holger Hutzenlaub, Boeblingen (DE);
Steffen Koehl, Stuttgart (DE); **Frank Pfisterer**, Weil der Stadt (DE); **Marco Schulz**, Holzgerlingen (DE)

(73) Assignee: **Daimler AG**, Stuttgart (DE)

(**) Term: **14 Years**

(21) Appl. No.: **29/309,077**

(22) Filed: **Jun. 18, 2008**

(30) **Foreign Application Priority Data**

Dec. 19, 2007 (EM) 000846621-0001
Dec. 19, 2007 (EM) 000846621-0002

(51) **LOC (9) Cl.** **12-08**

(52) **U.S. Cl.** **D12/92**

(58) **Field of Classification Search** D12/86,
D12/90-92; 296/181.1, 181.5
See application file for complete search history.

(56) **References Cited**

U.S. PATENT DOCUMENTS

D452,460 S * 12/2001 Sacco et al. D12/92
(Continued)

Primary Examiner—Melody N Brown

(74) *Attorney, Agent, or Firm*—Crowell & Moring LLP

(57) **CLAIM**

The ornamental design for a vehicle, toy replica and/or other replicas, as shown and described.

DESCRIPTION

This application is related to the following co-pending applications:

Application Ser. No. 29/309,078, entitled Front Portion of a Vehicle, Toy, or Likeness Thereof;

Application Ser. No. 29/309,071, entitled Front Bumper for a Vehicle;

Application Ser. No. 29/309,072, entitled Rear Portion of a Vehicle, Toy, or Likeness Thereof;

Application Ser. No. 29/309,070, entitled Radiator Grill for a Vehicle;

Application Ser. No. 29/309,074, entitled Vehicle, Toy, or Likeness Thereof; and

Application Ser. No. 29/309,075, entitled Rear Portion of a Vehicle, Toy, or Likeness Thereof.

FIG. 1 is a left, front perspective view of a embodiment of a vehicle, toy replica and/or other replicas according to our novel design, the right, front perspective view being mirror symmetrical;

FIG. 2 is a left, rear perspective view thereof, the right, rear perspective view being mirror symmetrical;

FIG. 3 is a left side view thereof;

FIG. 4 is a right side view thereof;

FIG. 5 is a front view thereof;

FIG. 6 is a rear view thereof; and

FIG. 7 is a top view thereof.

FIG. 8 is a left, front perspective view of a second embodiment of the vehicle, toy replica and/or other replicas according to our novel design, the right, front perspective view being mirror symmetrical;

FIG. 9 is a left, rear perspective view thereof, the right, rear perspective view being mirror symmetrical;

FIG. 10 is a left side view thereof;

FIG. 11 is a right side view thereof;

FIG. 12 is a front view thereof;

FIG. 13 is a rear view thereof; and,

FIG. 14 is a top view thereof.

The broken lines are for illustrative purposes only and form no part of the claimed design.

1 Claim, 12 Drawing Sheets

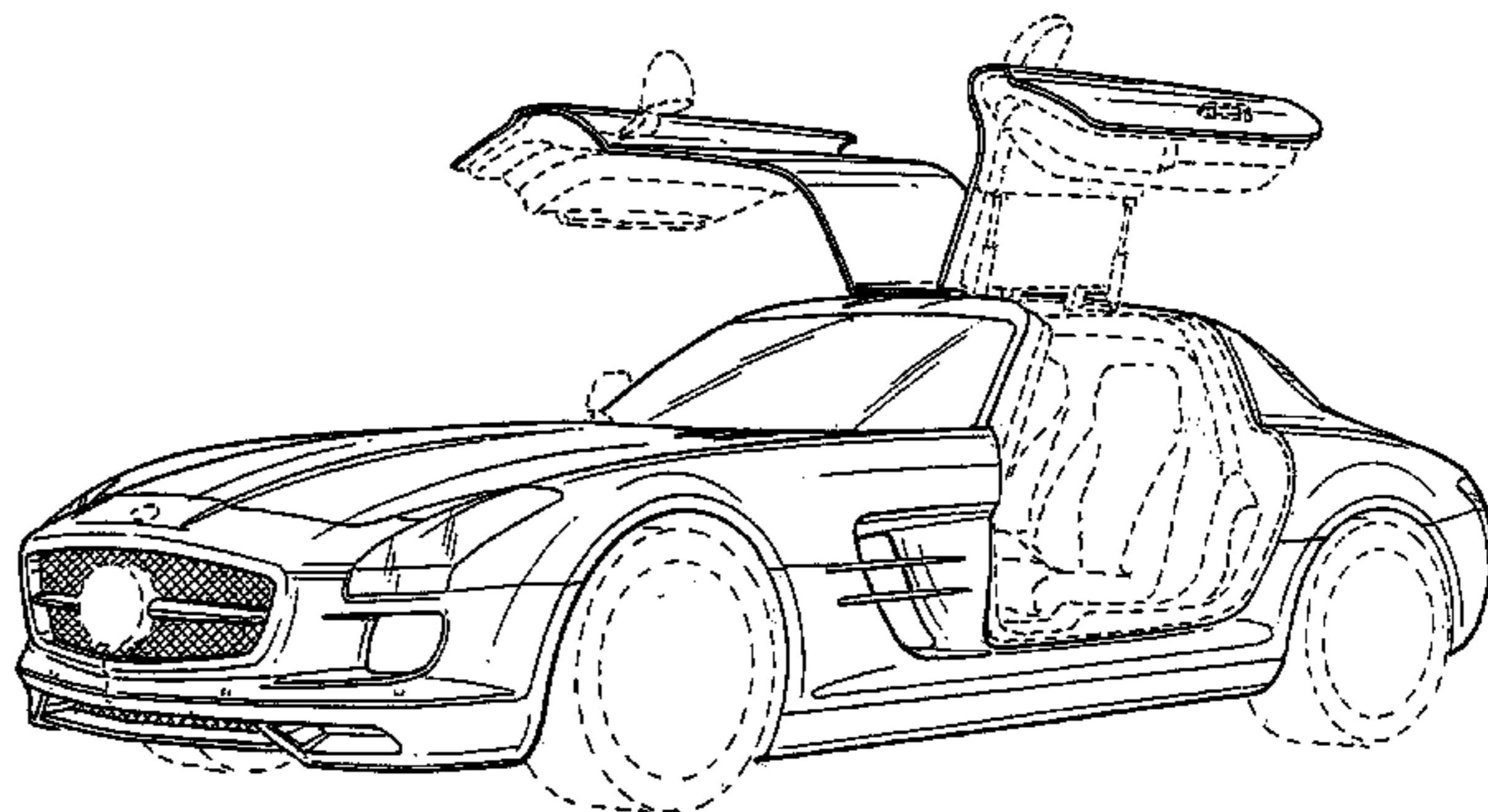
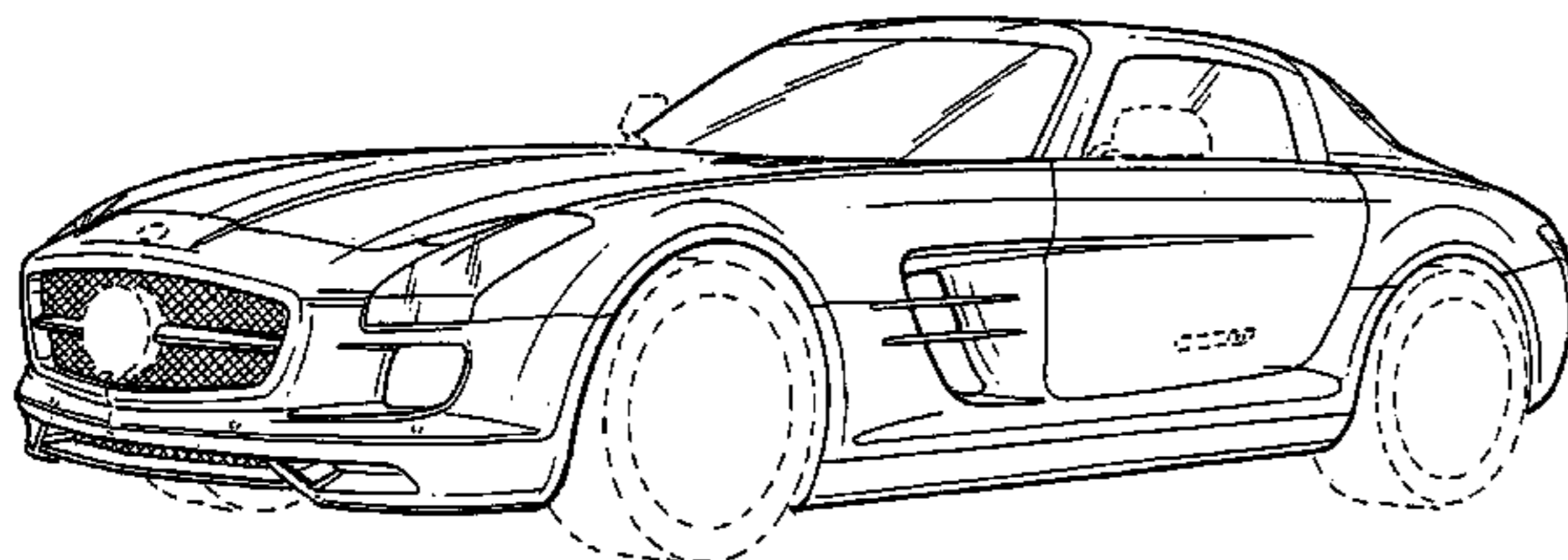

US D610,043 S

Page 2

U.S. PATENT DOCUMENTS

D552,015 S	*	10/2007	Pfeiffer	D12/92	
D588,499 S	*	3/2009	Pfeiffer	D12/92	* cited by examiner
						D596,078 S * 7/2009 Pfeiffer et al. D12/92

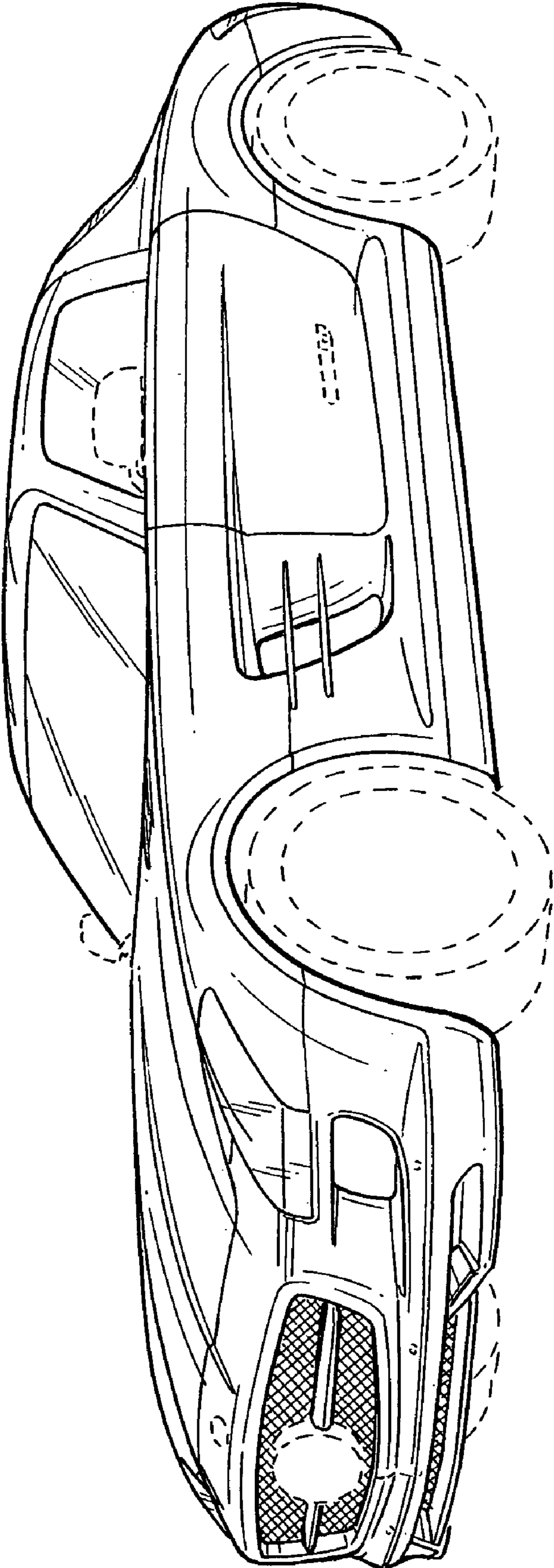

FIG. 1

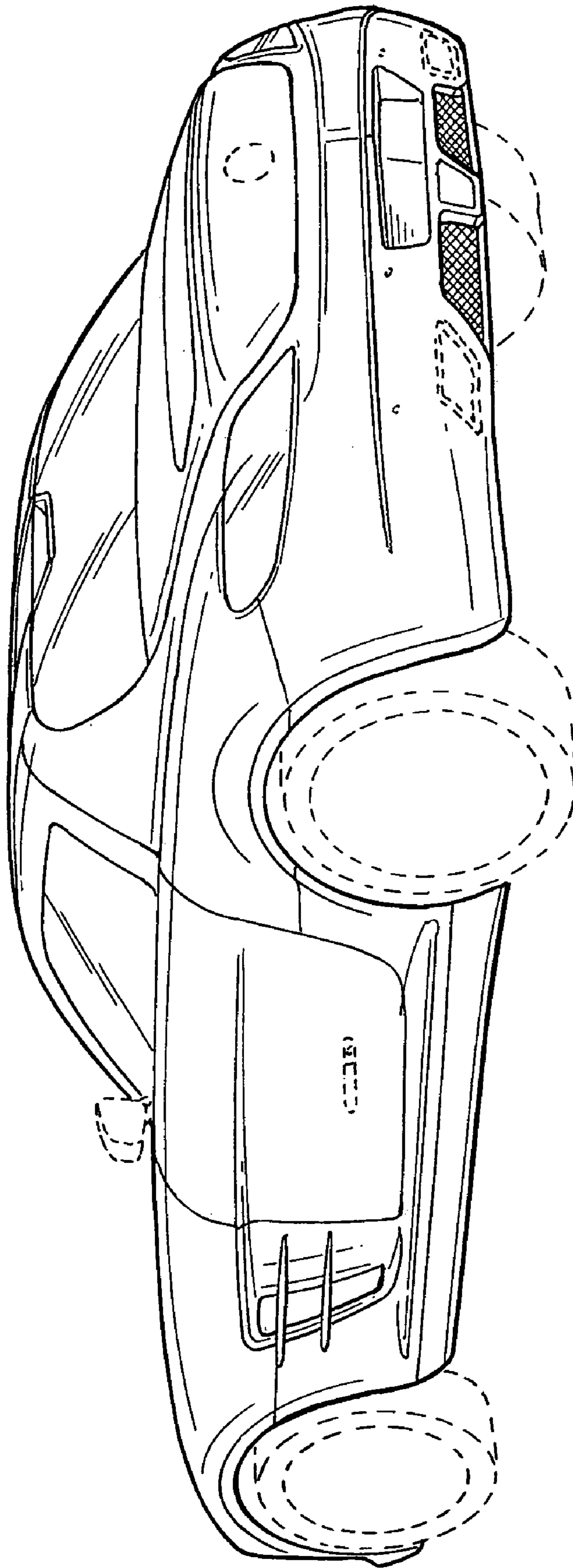

FIG. 2

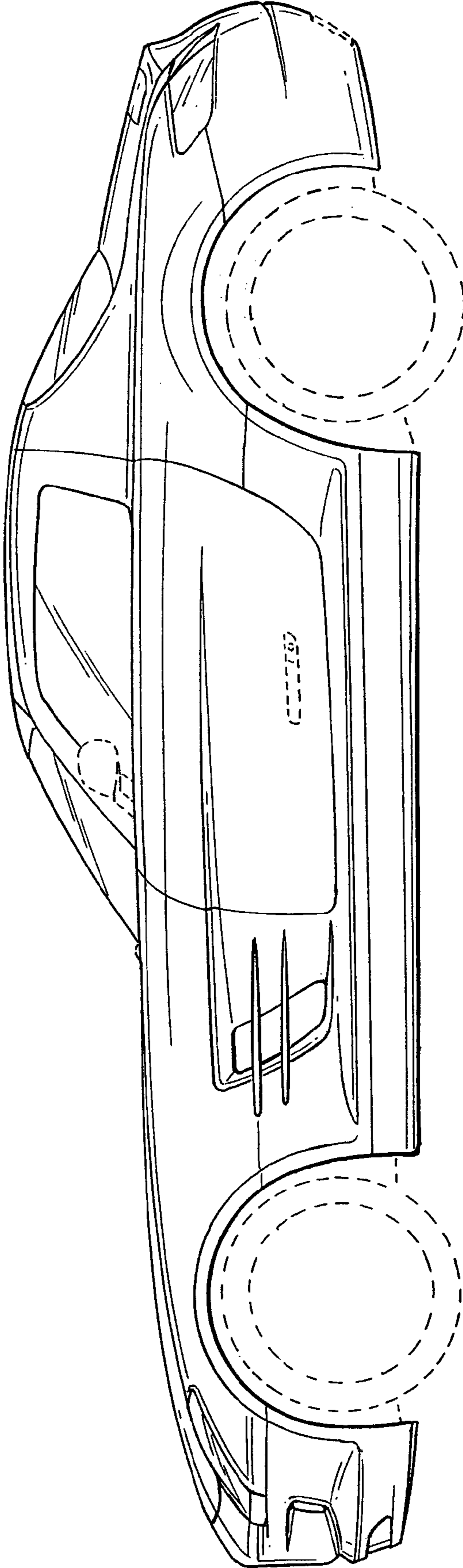

FIG. 3

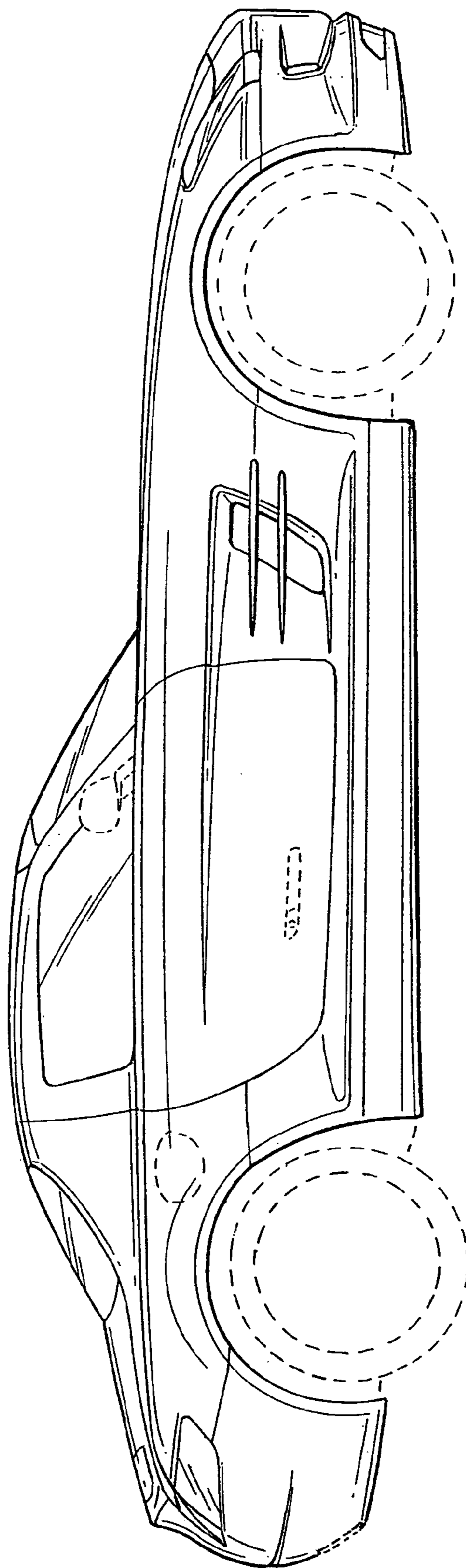

FIG. 4

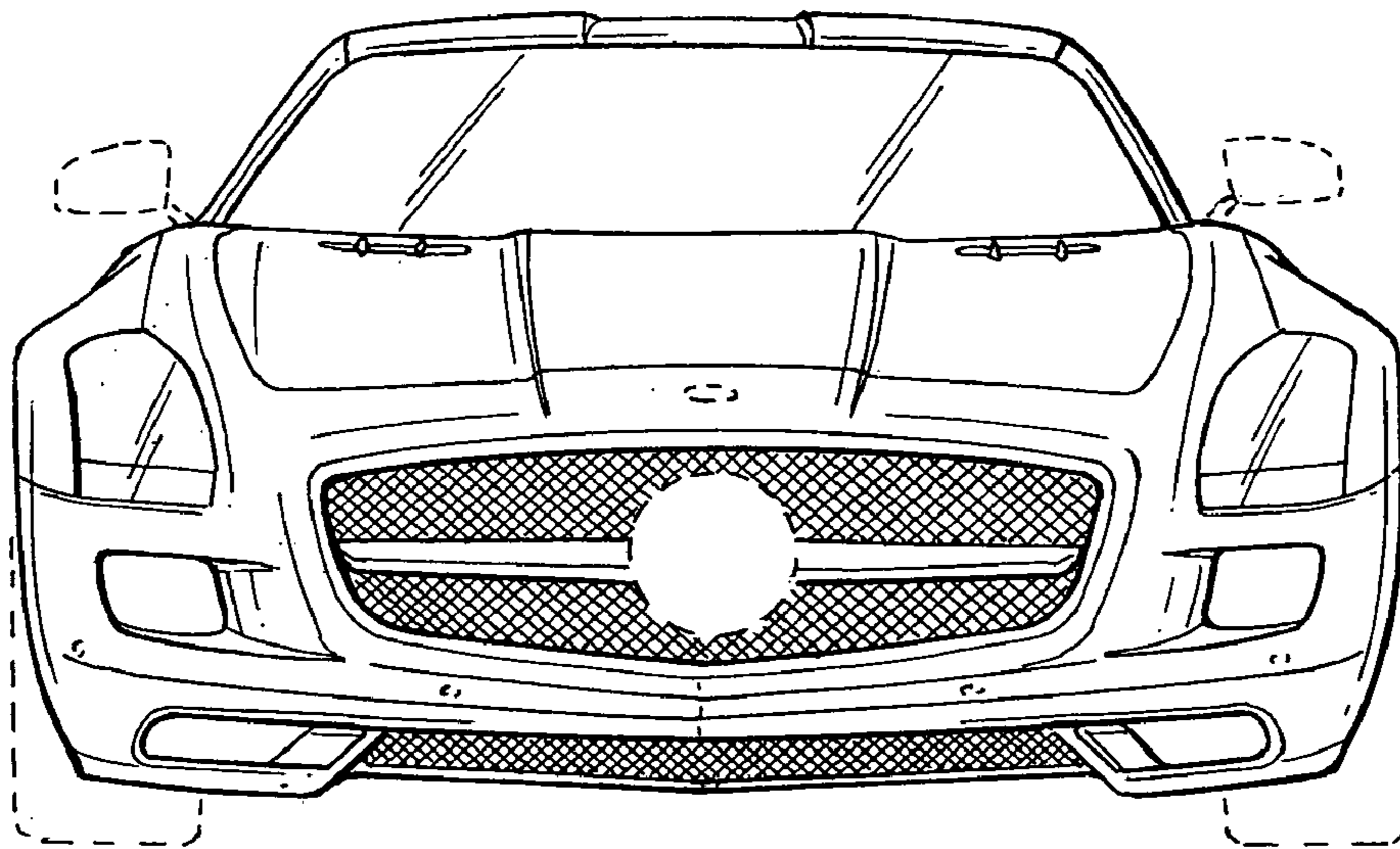

FIG. 5

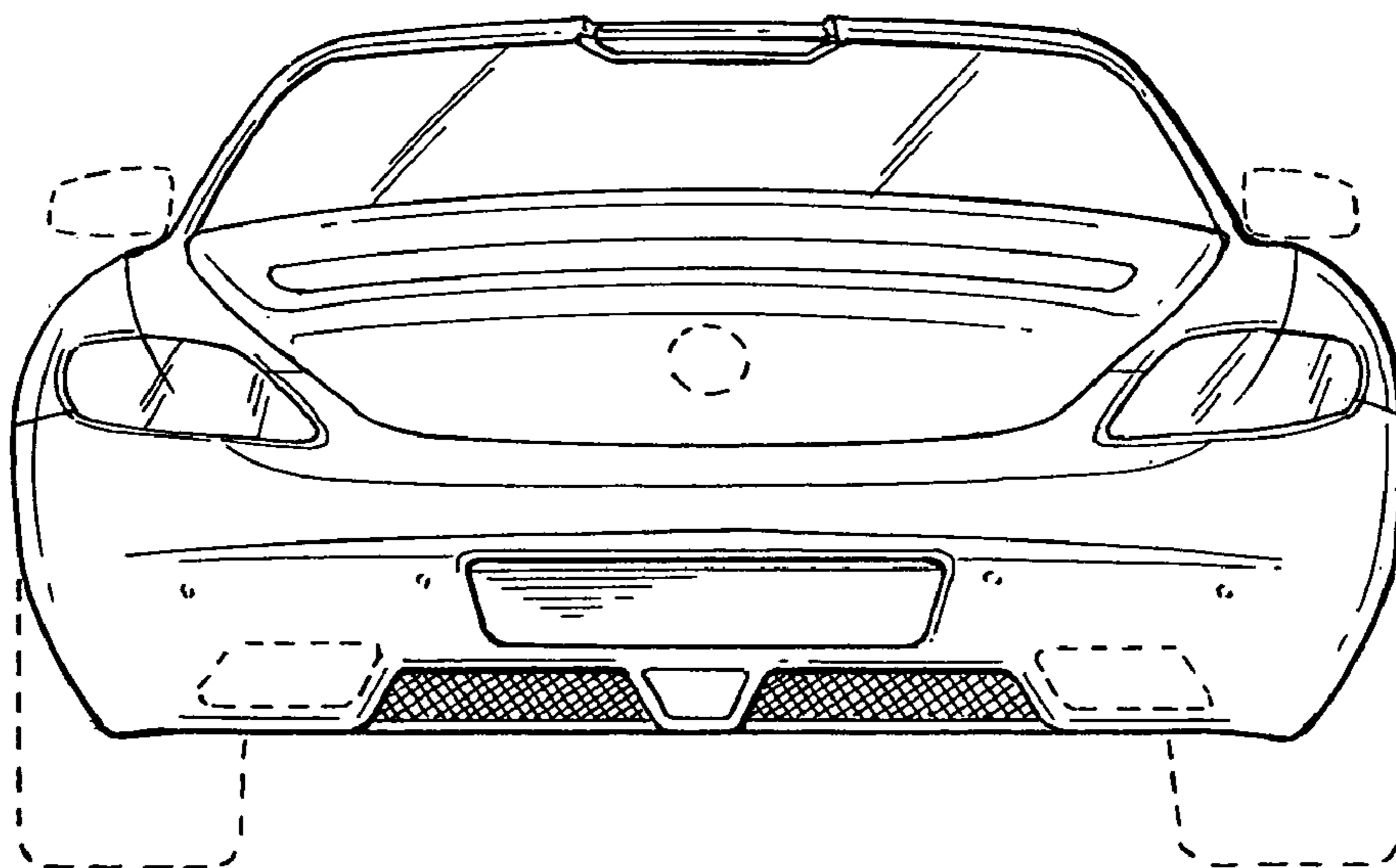

FIG. 6

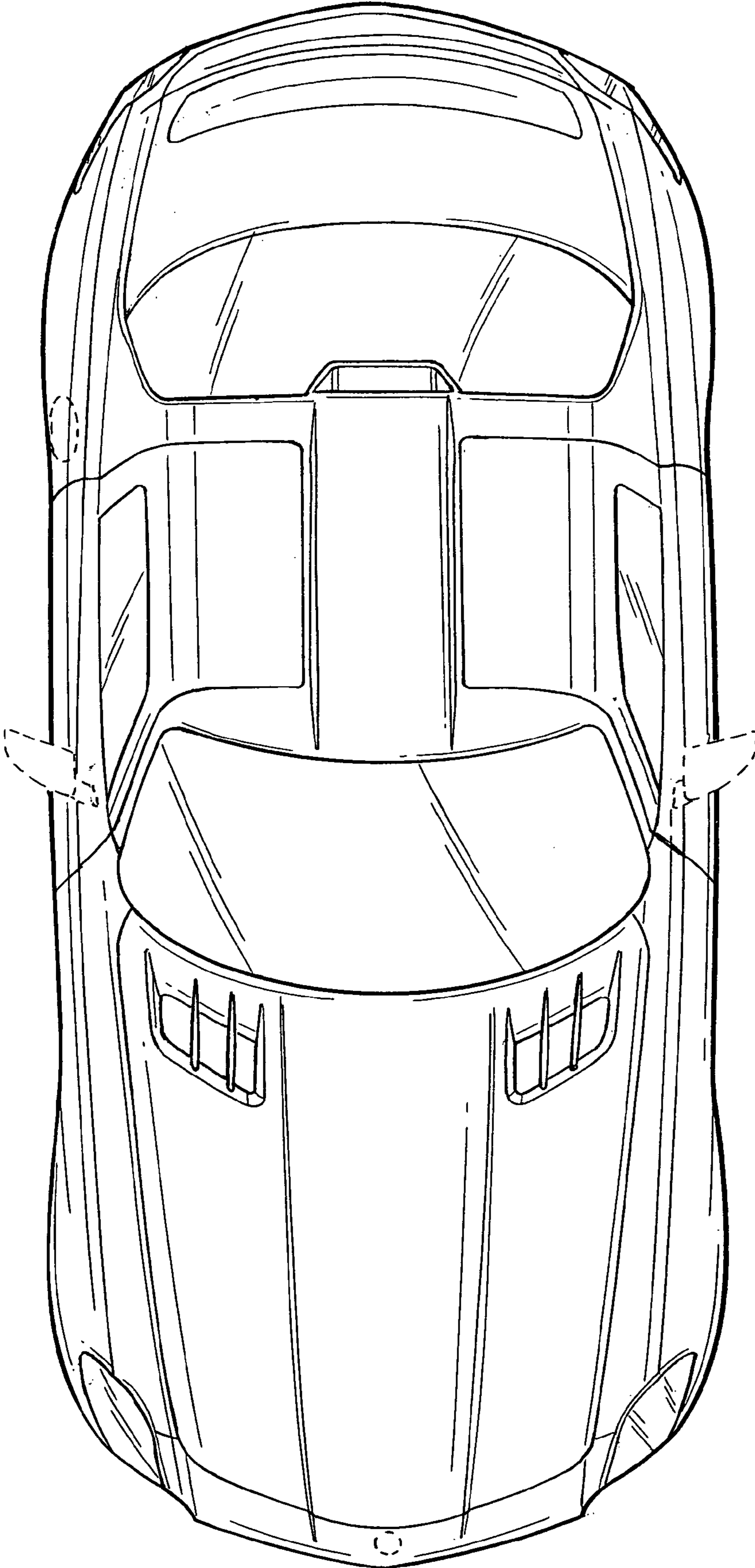

FIG. 7

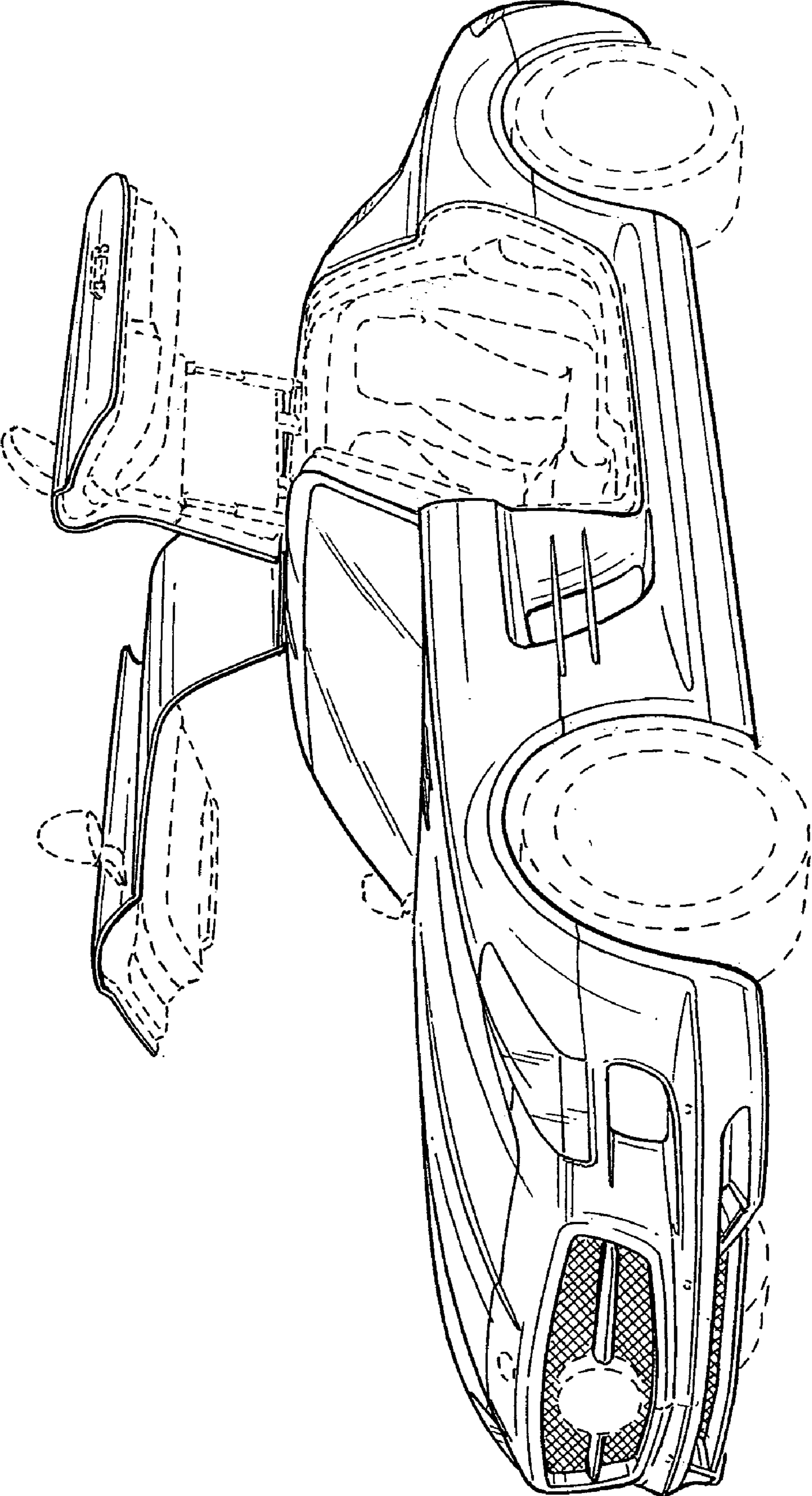

FIG. 8

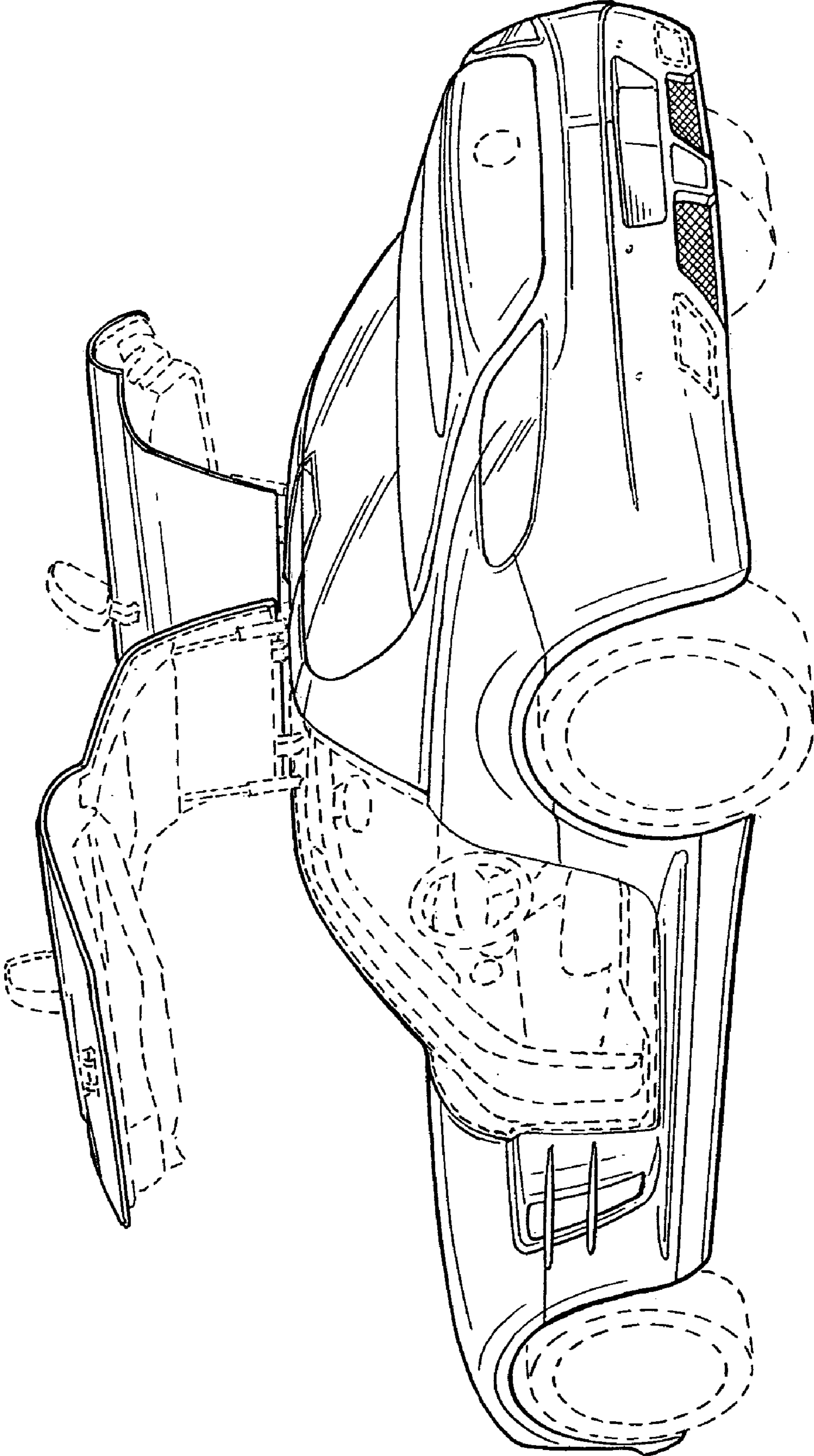

FIG. 9

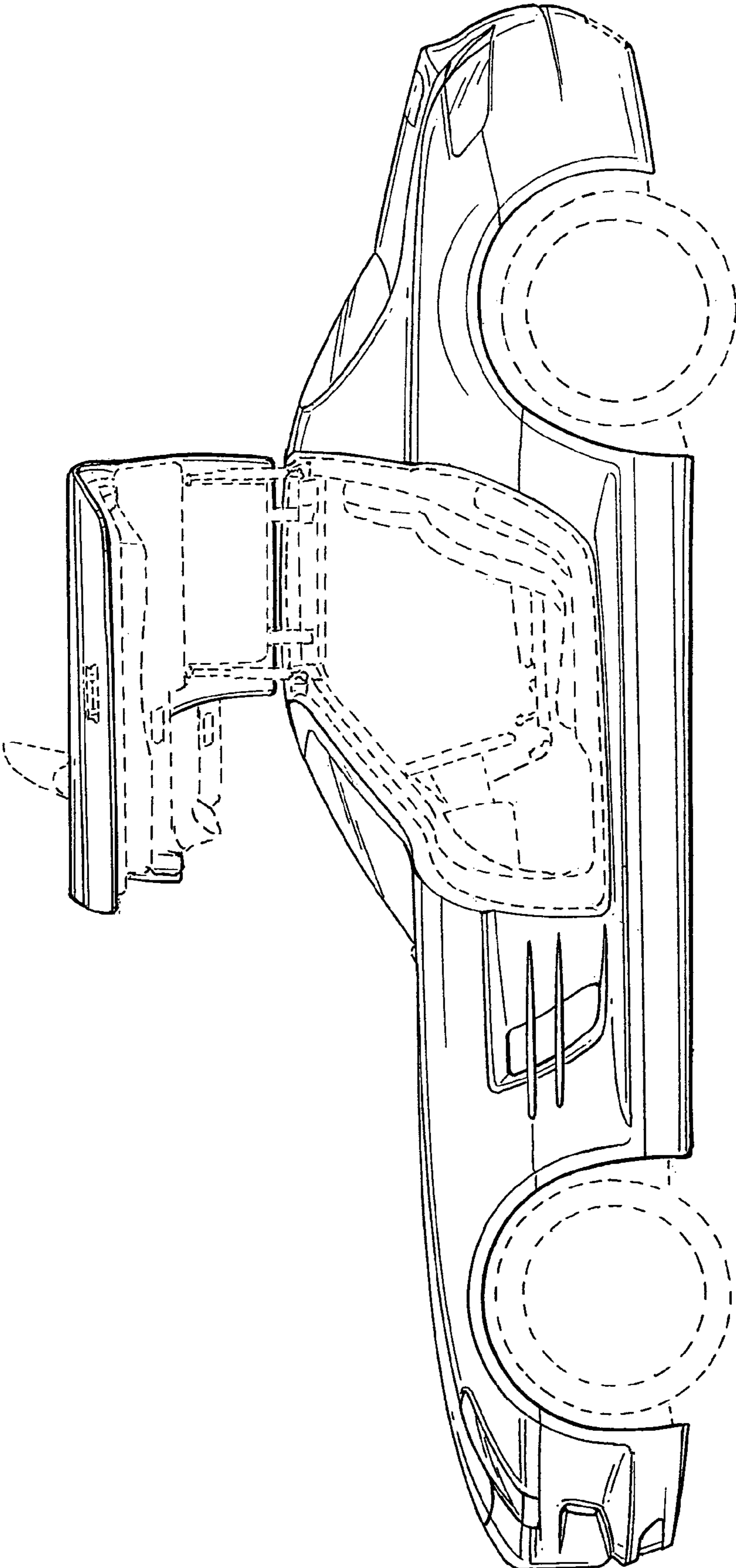

FIG. 10

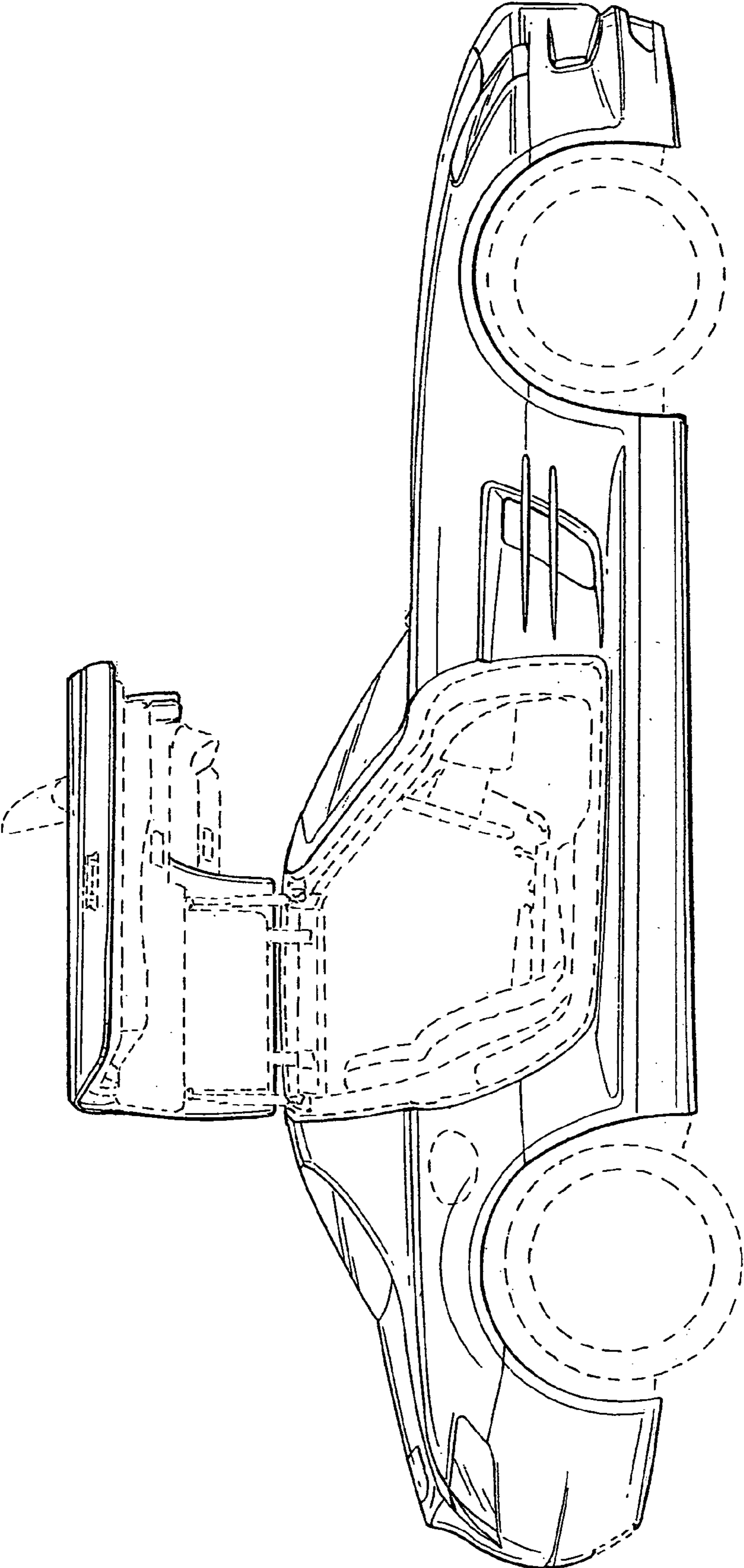

FIG. 11

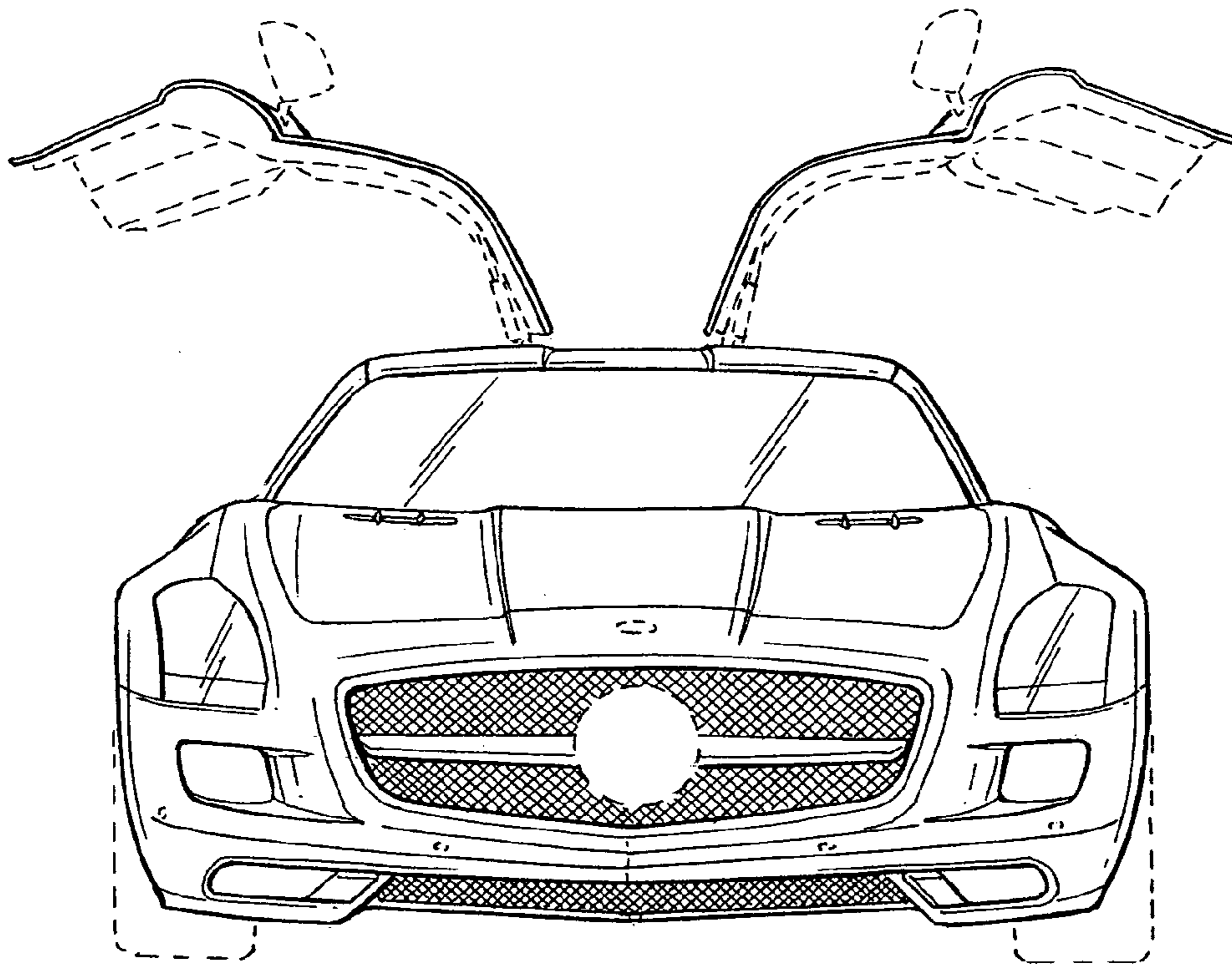

FIG. 12

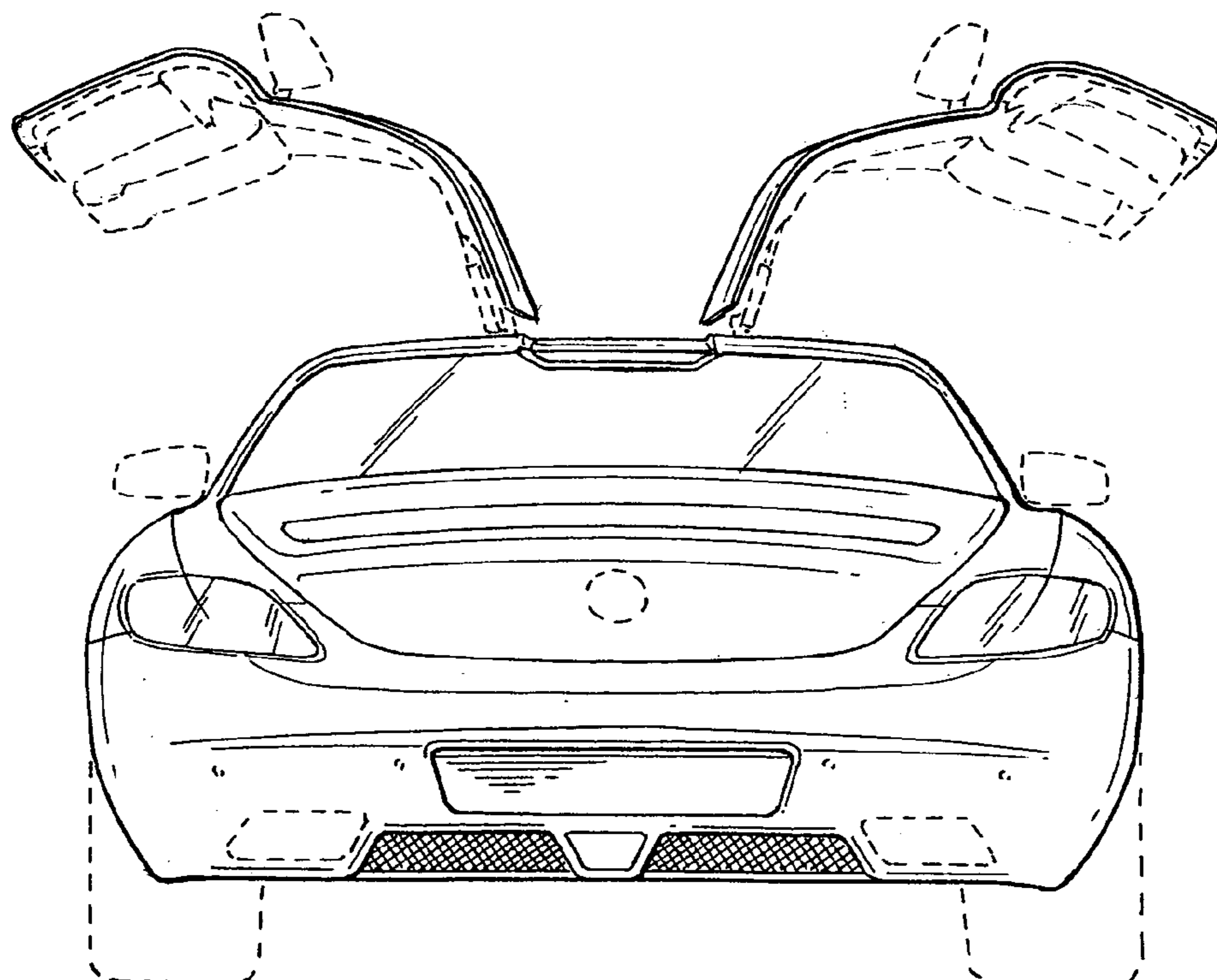

FIG. 13

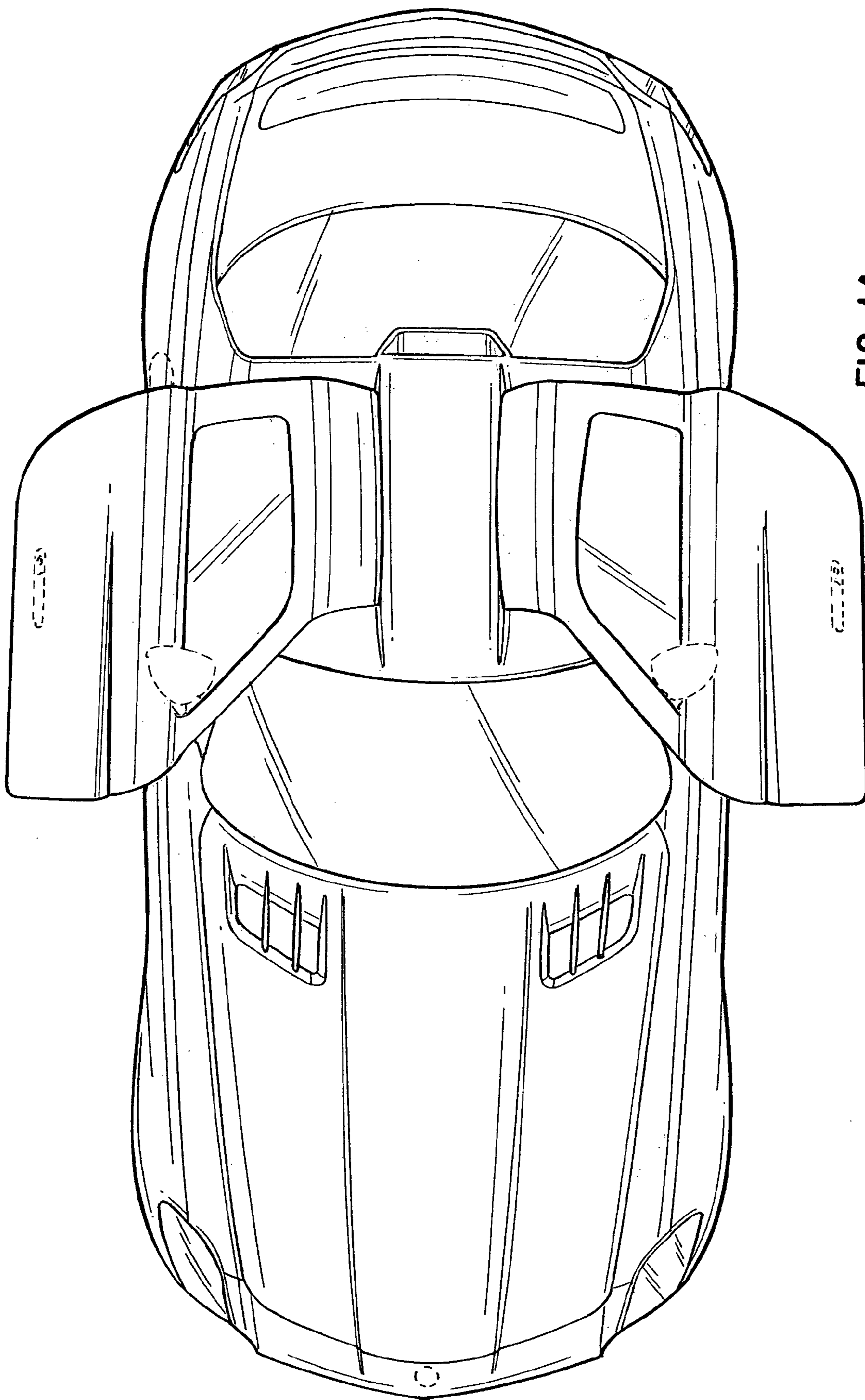

FIG. 14