



US00D610038S

(12) **United States Design Patent**
Kiel et al.

(10) **Patent No.:** **US D610,038 S**
(45) **Date of Patent:** **** Feb. 16, 2010**

(54) **GUNNER PROTECTION ENCLOSURE WITH OVERHEAD COVER**

D275,271 S * 8/1984 LeBlanc D12/12

(75) Inventors: **Thomas J. Kiel**, Bernardsville, NJ (US);
Edward Zuckerman, Denville, NJ (US);
Sanjay Parimi, Chester, NJ (US)

* cited by examiner

(73) Assignee: **The United States of America as represented by the Secretary of the Army**, Washington, DC (US)

Primary Examiner—T. Chase Nelson

Assistant Examiner—Ania K Dworzecka

(74) *Attorney, Agent, or Firm*—Henry S. Goldfine

(**) Term: **14 Years**

(57) **CLAIM**

(21) Appl. No.: **29/340,305**

The ornamental design for a gunner protection enclosure with overhead cover, as shown and described.

(22) Filed: **Jul. 16, 2009**

Related U.S. Application Data

DESCRIPTION

(63) Continuation-in-part of application No. 12/501,580, filed on Jul. 13, 2009, which is a continuation-in-part of application No. 11/682,440, filed on Apr. 6, 2007.

The invention described and claimed herein may be manufactured, used, and licensed by or for the U.S. Government for U.S. Government purposes.

(51) **LOC (9) Cl.** **12-13**

(52) **U.S. Cl.** **D12/12**

(58) **Field of Classification Search** D12/86-89,
D12/12, 91, 92, 1-4, 98-100; D21/533,
D21/539, 548-552, 557-60, 579, 580-583,
D21/442, 436, 447, 560, 86, 91; 180/232,
180/242, 89.12, 449; 410/57; 89/36.8, 36.09,
89/37.03, 38, 40.03, 36 F, 36 H, 4 B, 36.1,
89/36.13, 36.04, 36.01, 36.02; 446/471,
446/487; 296/181.3, 1.01, 183, 24.1, 37.6,
296/185, 186, 204, 186.1; 280/838, 839

FIG. 1 is a perspective view of a gunner protection enclosure with overhead cover showing our new design;

FIG. 2 is a second, close-up perspective view thereof;

FIG. 3 is a front elevation view thereof;

FIG. 4. Is a rear elevation view thereof;

FIG. 5 is a left side elevation view thereof;

FIG. 6 is a right side elevation view thereof;

FIG. 7 is a top plan view thereof; and,

FIG. 8 is perspective view of a second embodiment thereof.

The broken lines shown in FIG. 1 depict environmental subject matter only and form no part of the claimed design.

See application file for complete search history.

(56) **References Cited**

U.S. PATENT DOCUMENTS

D275,270 S * 8/1984 LeBlanc D12/12

1 Claim, 8 Drawing Sheets

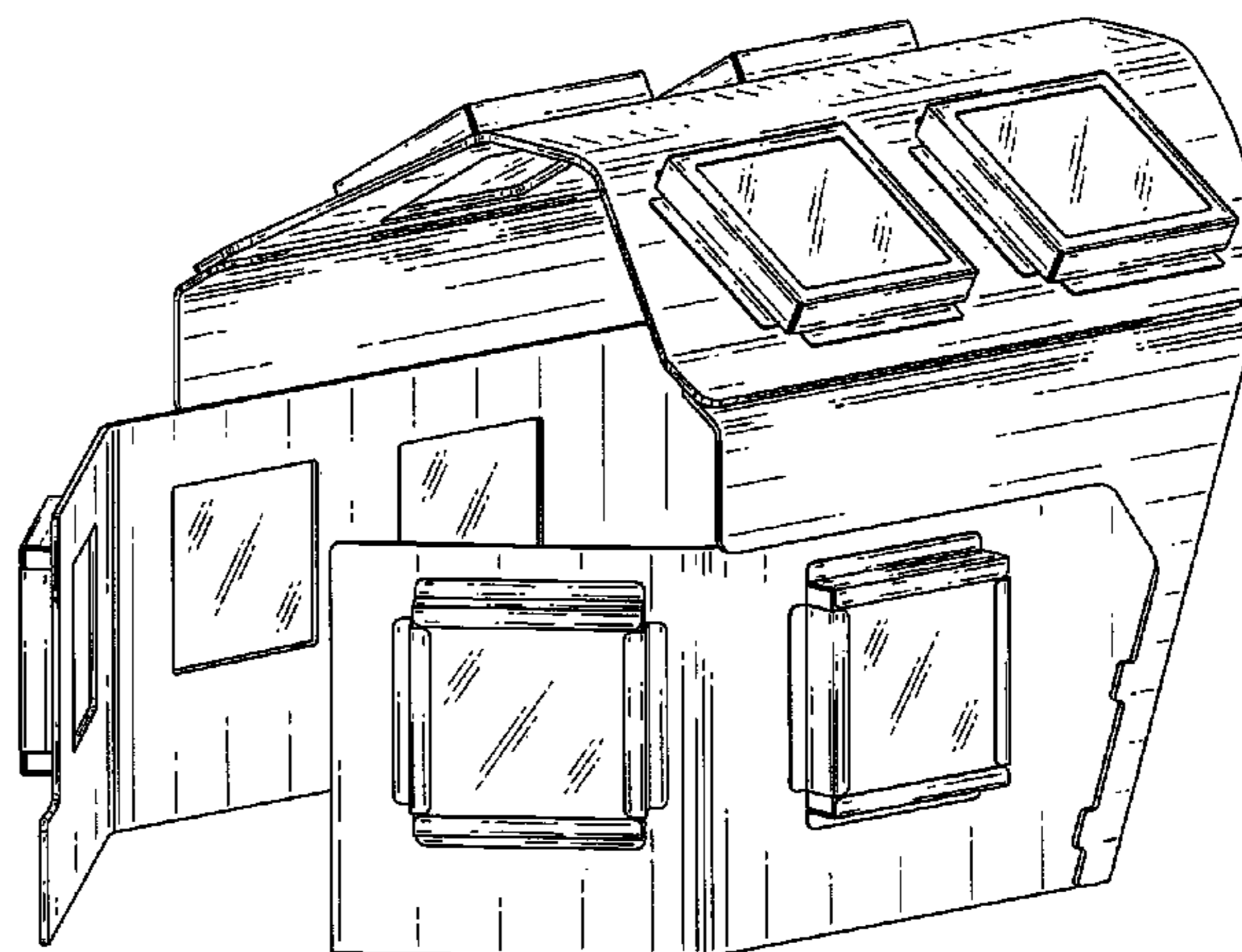
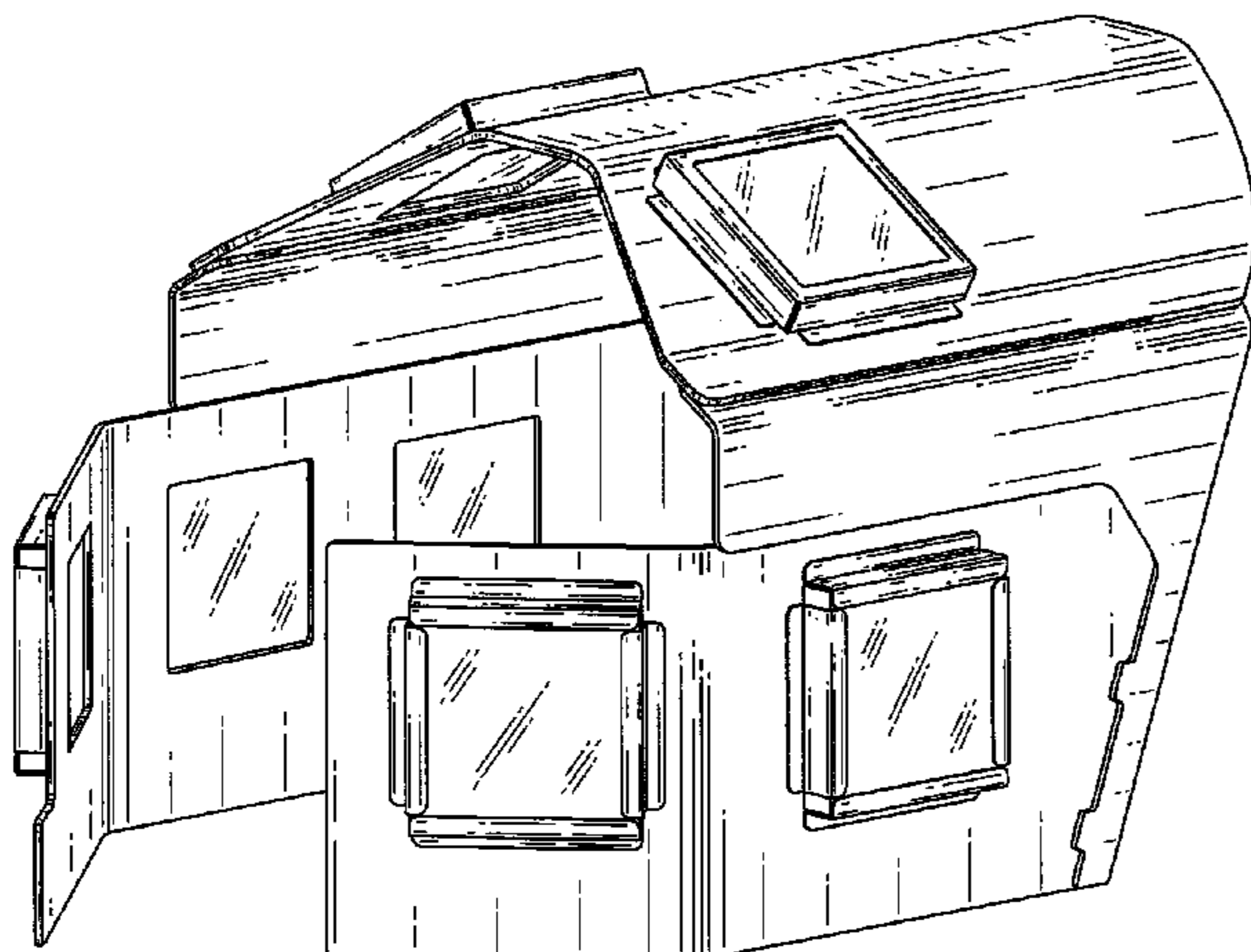

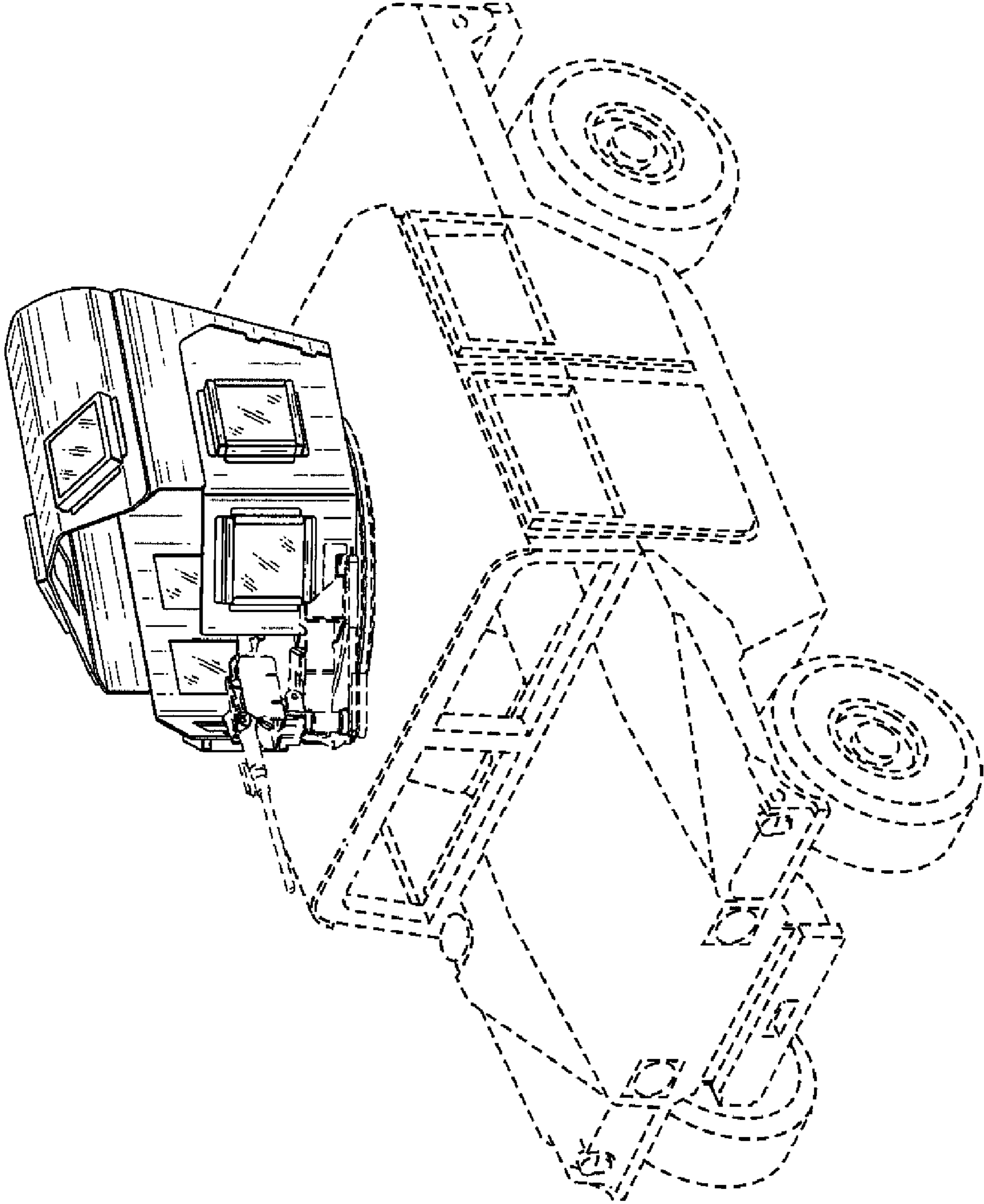
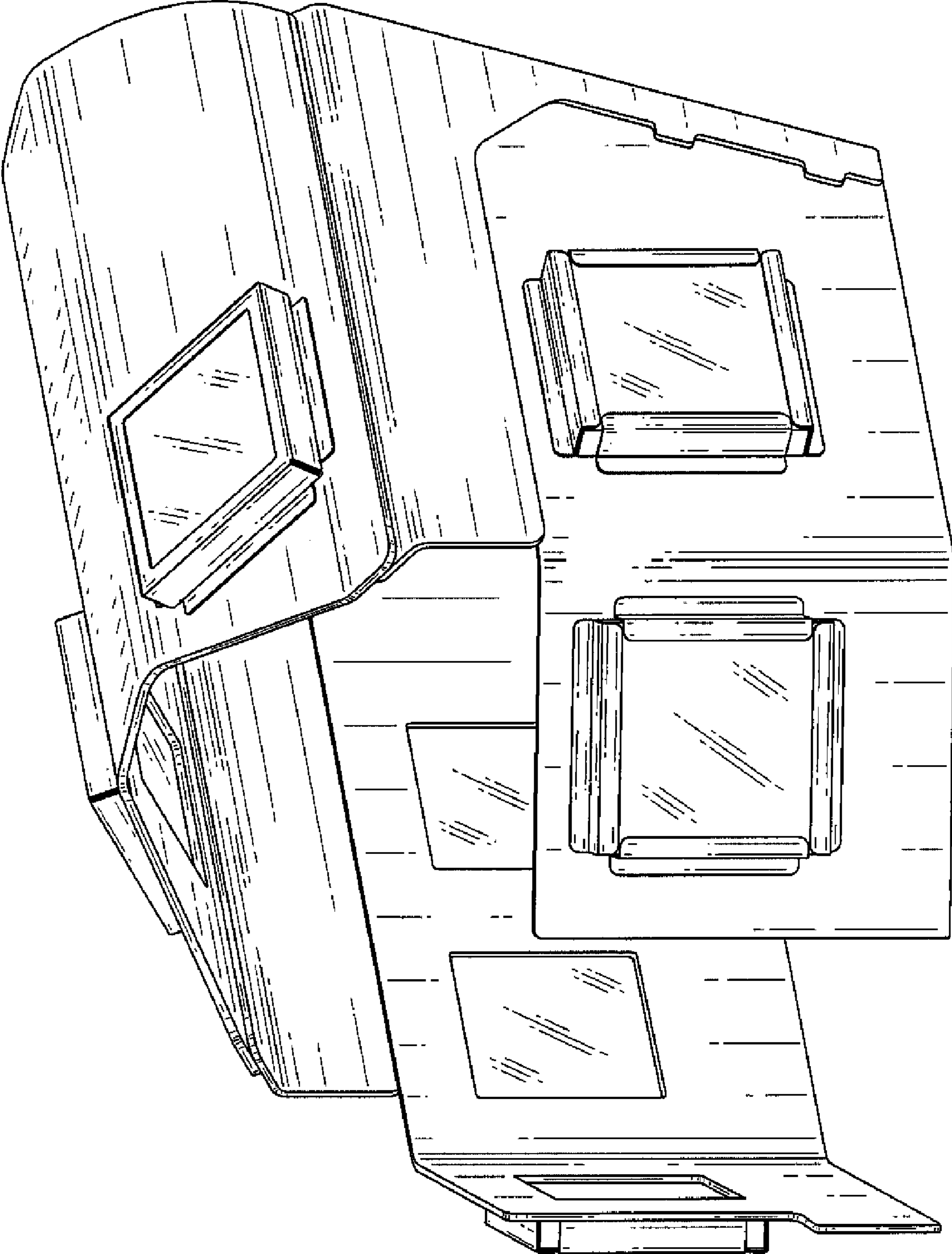

FIG. 1

FIG. 2



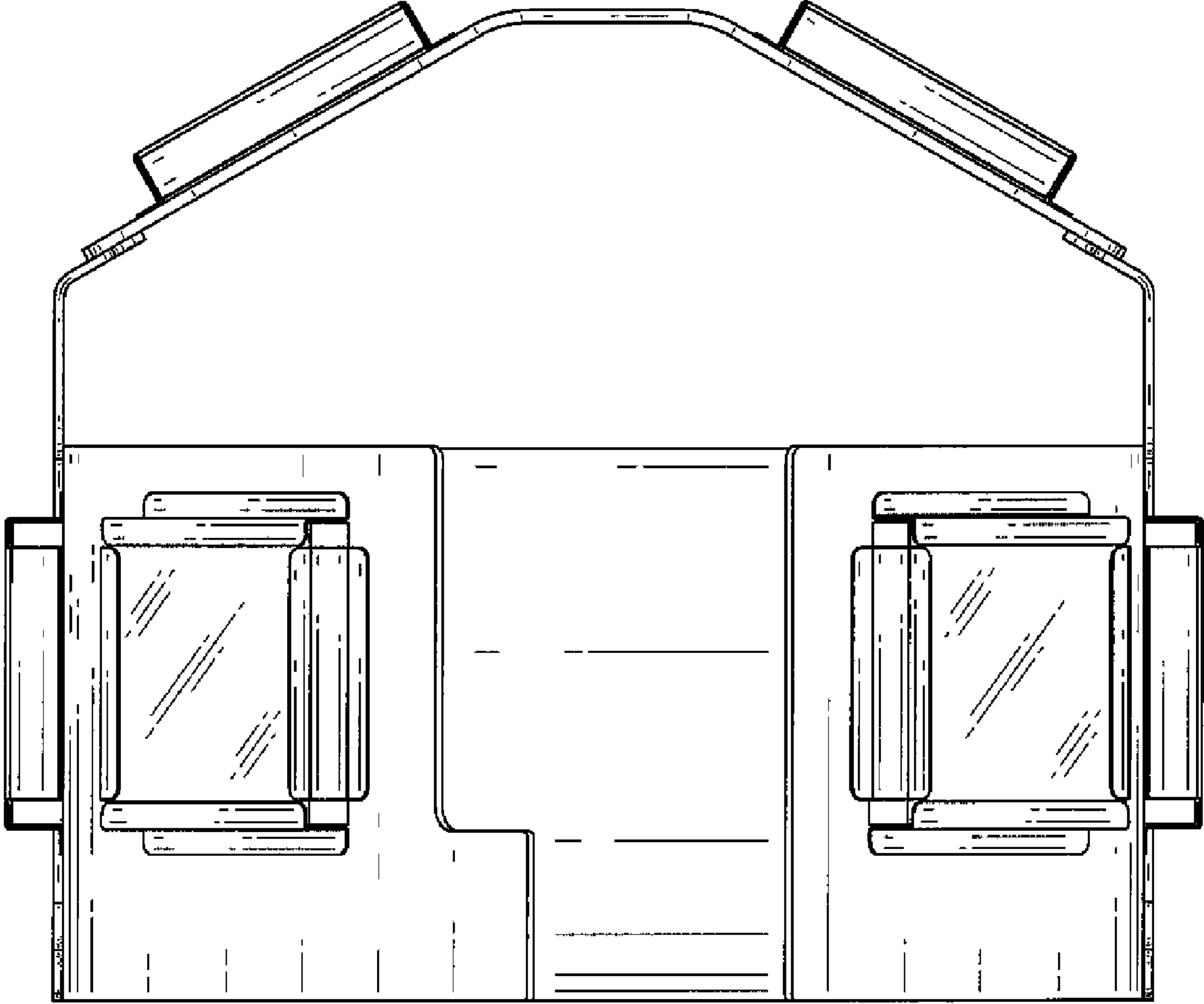

FIG. 3

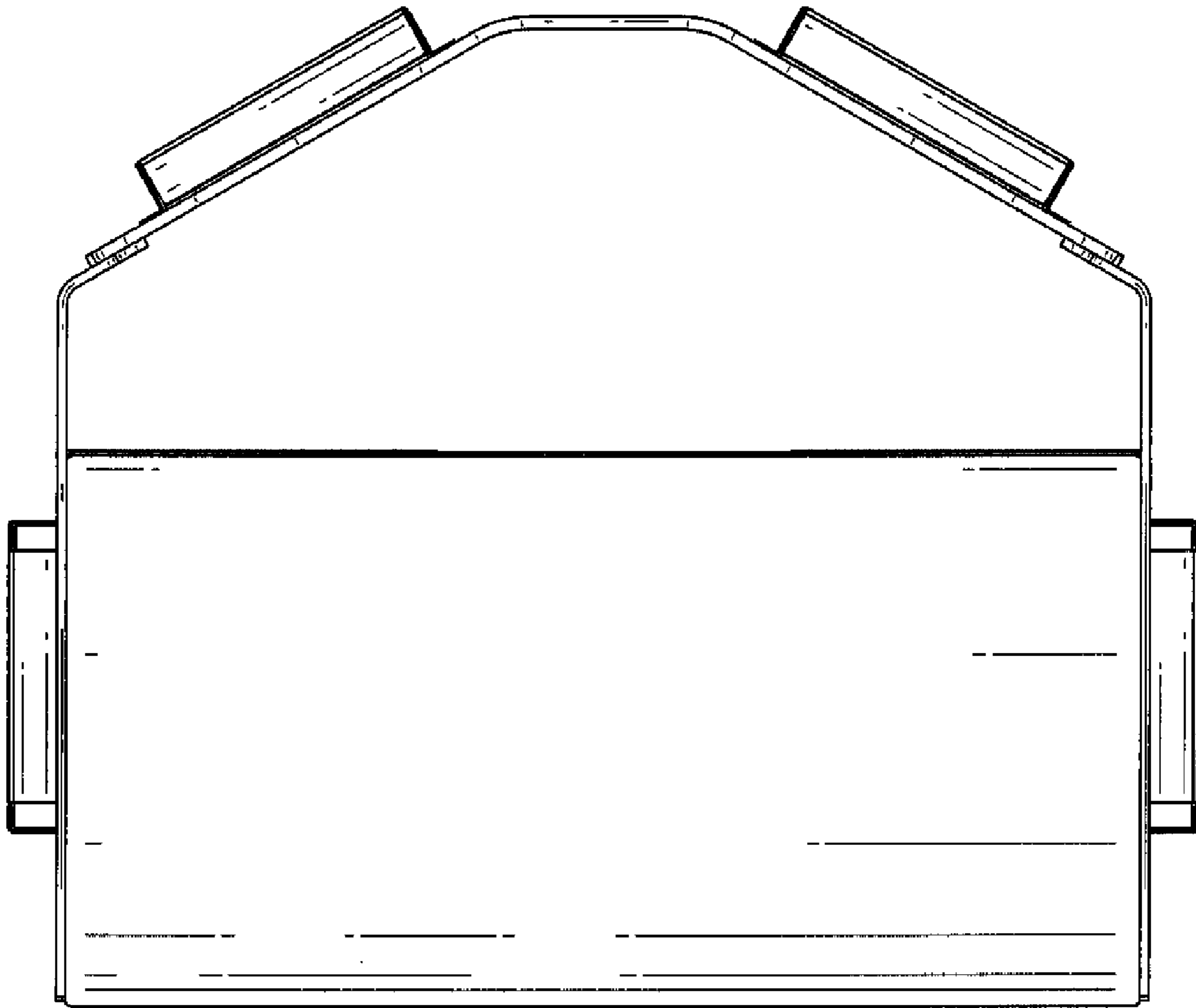

FIG. 4

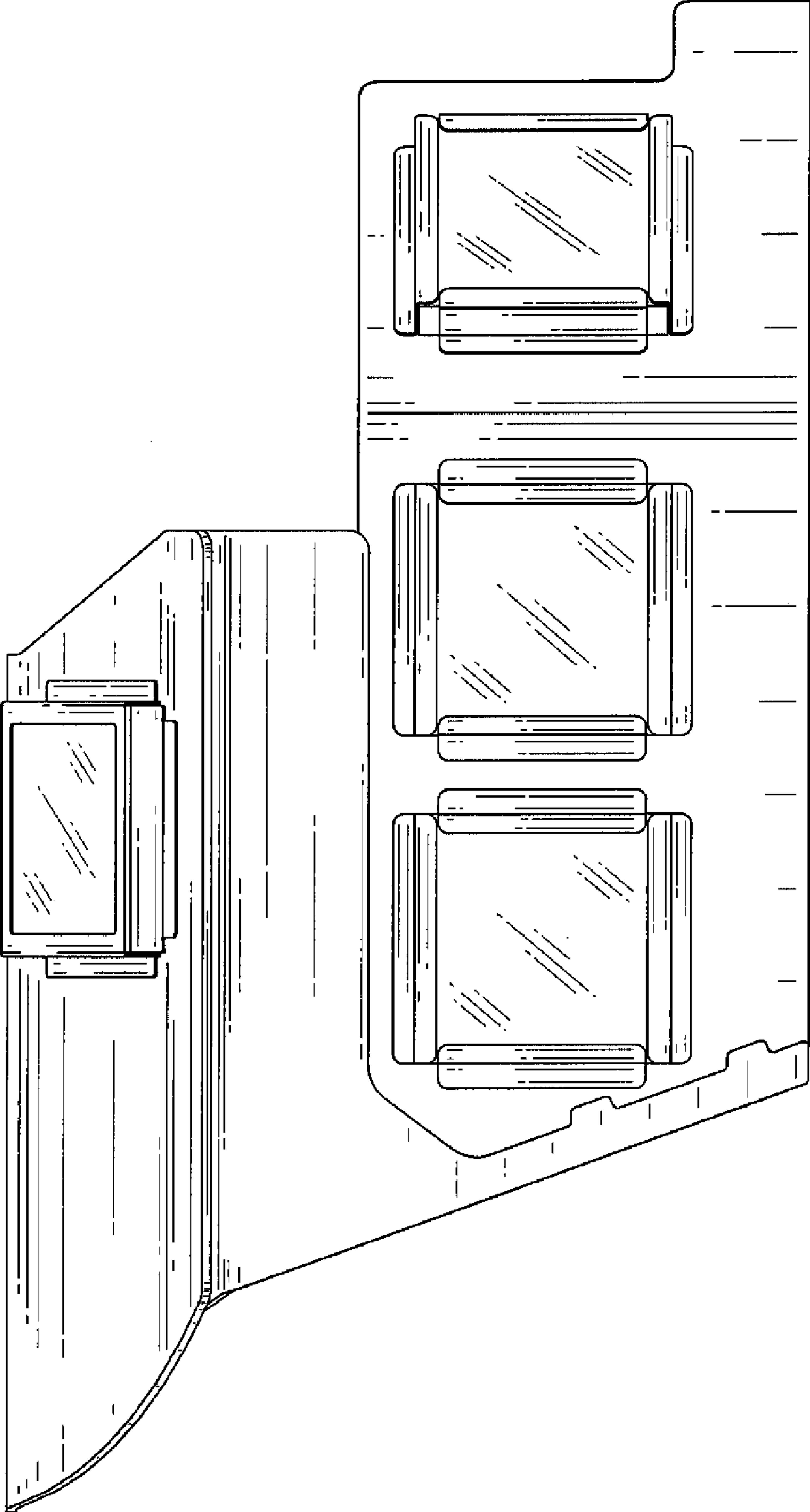

FIG. 5

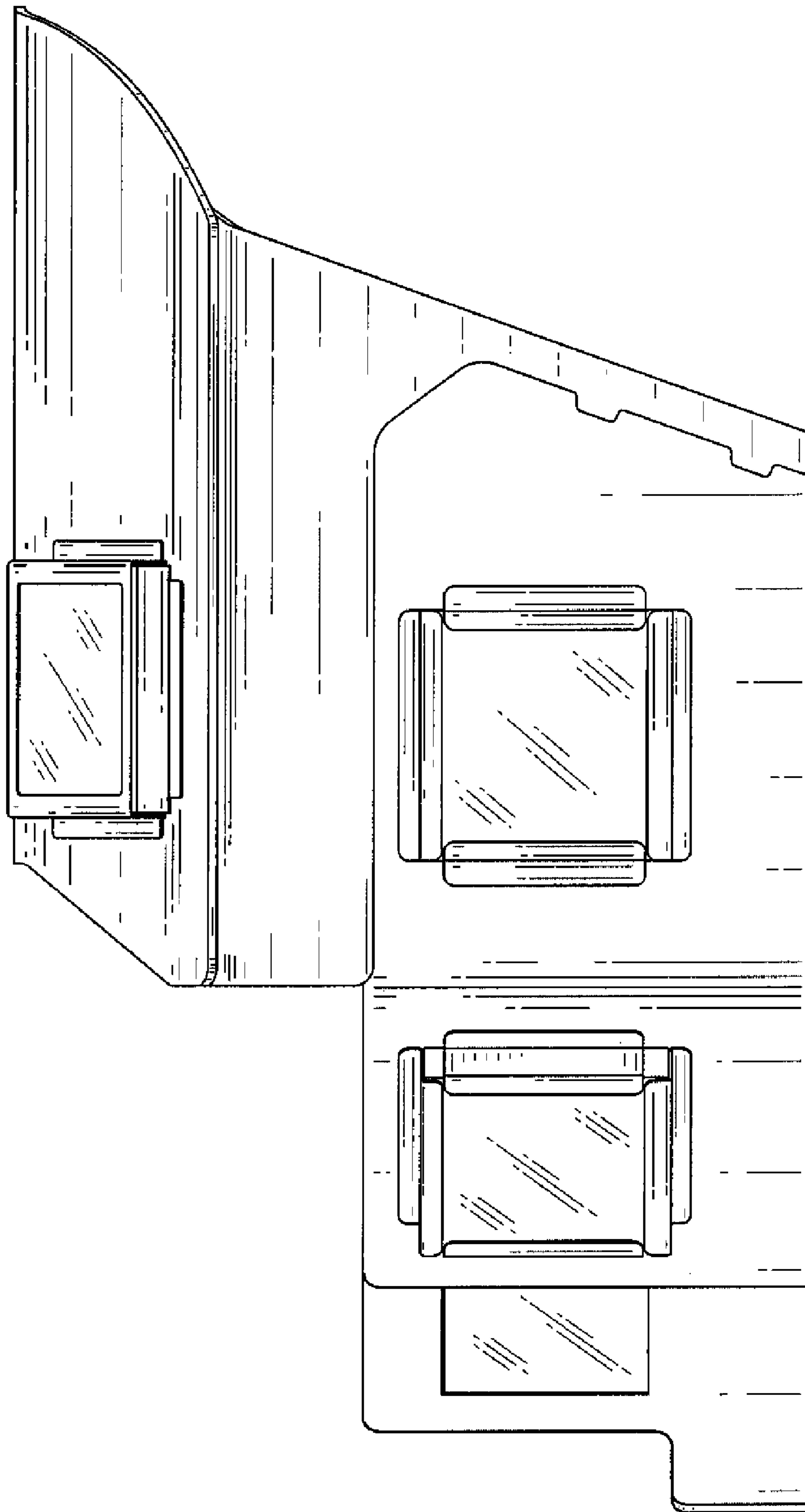

FIG. 6

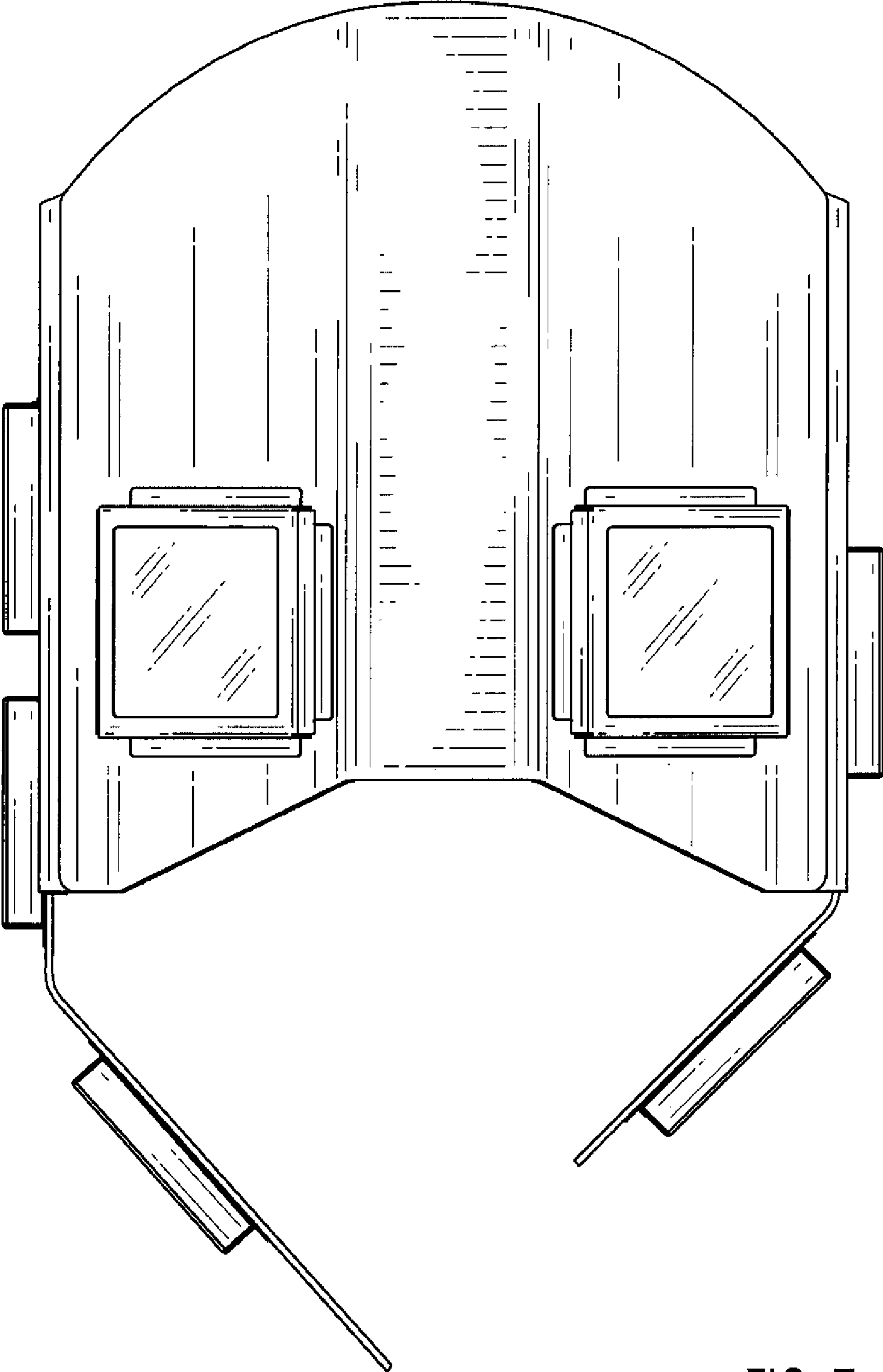

FIG. 7

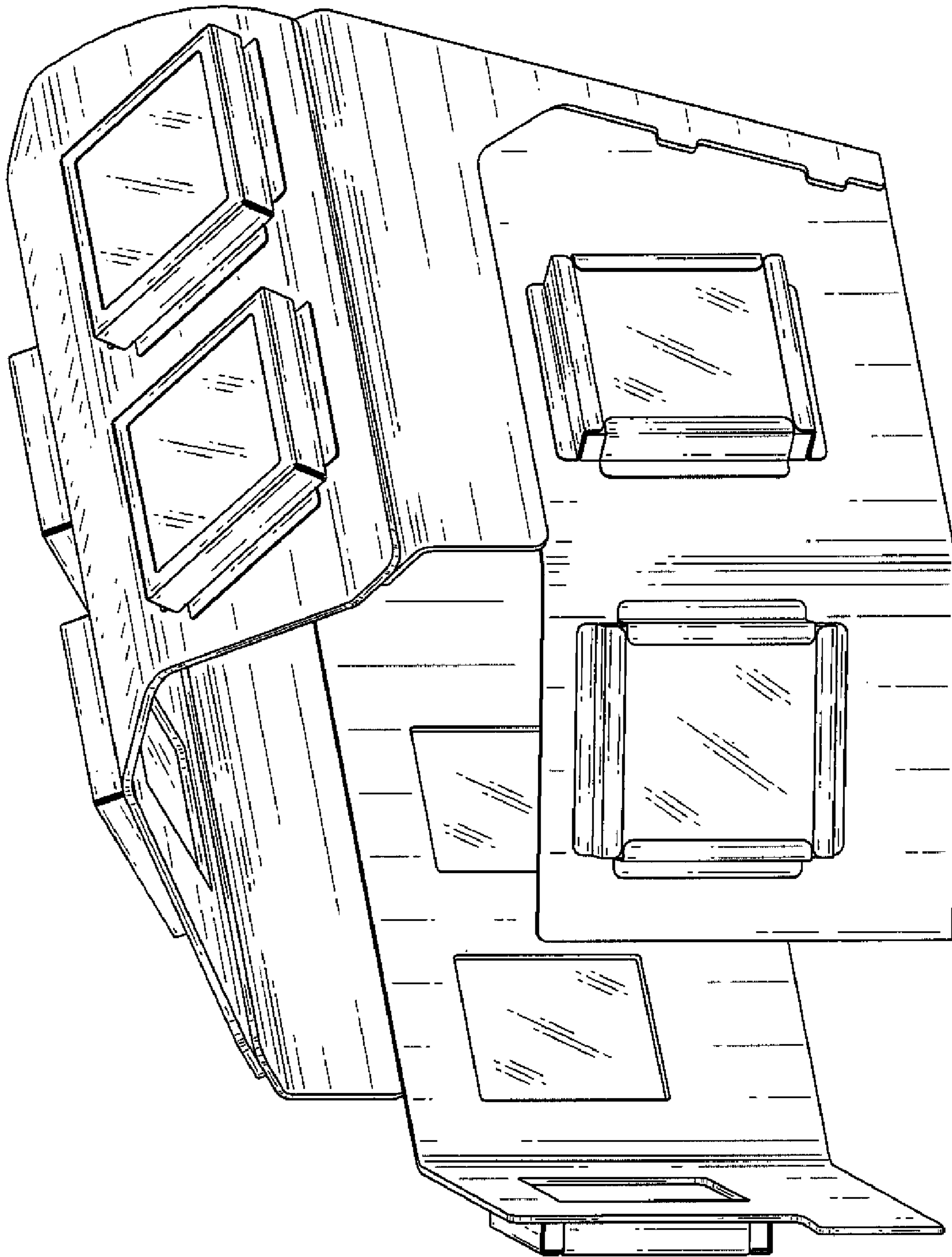

FIG. 8