



US00D609970S

(12) **United States Design Patent**  
**Richau et al.**

(10) **Patent No.:** **US D609,970 S**  
(45) **Date of Patent:** **\*\* Feb. 16, 2010**

(54) **BEVERAGE CONTAINER**

(75) Inventors: **Jennie Richau**, Denver, CO (US);  
**Christopher G. Alviar**, Seattle, WA  
(US)

(73) Assignee: **Pacific Market International, LLC**,  
Seattle, WA (US)

(\*\*) Term: **14 Years**

(21) Appl. No.: **29/317,773**

(22) Filed: **May 6, 2008**

(51) **LOC (9) Cl.** ..... **07-01**

(52) **U.S. Cl.** ..... **D7/510; D7/511; D7/533**

(58) **Field of Classification Search** ..... **D7/510,**  
**D7/511, 507, 523, 396.2, 396.6; 206/459.1;**  
**220/288, 703, 592.16; 215/13.1**

See application file for complete search history.

(56) **References Cited**

**U.S. PATENT DOCUMENTS**

6,783,020	B2 *	8/2004	Featherston et al. ....	220/254.8
D557,560	S *	12/2007	Wahl .....	D7/510
D587,967	S *	3/2009	Wahl .....	D7/510
D592,909	S *	5/2009	Alviar et al. ....	D7/510
D598,243	S *	8/2009	Gilbert et al. ....	D7/533
D598,712	S *	8/2009	Alviar et al. ....	D7/510
D599,168	S *	9/2009	Alviar et al. ....	D7/510
D599,622	S *	9/2009	Gilbert et al. ....	D7/538
7,581,640	B2 *	9/2009	Lopez .....	206/459.1

\* cited by examiner

*Primary Examiner*—Marianne Pandozzi  
(74) *Attorney, Agent, or Firm*—Davis Wright Tremaine LLP;  
George C. Rondeau, Jr.

(57) **CLAIM**

The ornamental design for a beverage container, as shown and described.

**DESCRIPTION**

FIG. 1 is a top rear perspective view of a beverage container showing our new design.

FIG. 2 is a right side elevational view thereof.

FIG. 3 is a left side elevational view thereof.

FIG. 4 is a rear elevational view thereof.

FIG. 5 is a front elevational view thereof.

FIG. 6 is a top plan view thereof.

FIG. 7 is a bottom plan view thereof.

FIG. 8 is a top rear perspective view of a second embodiment thereof.

FIG. 9 is a right side elevational view thereof.

FIG. 10 is a left side elevational view thereof.

FIG. 11 is a rear elevational view thereof.

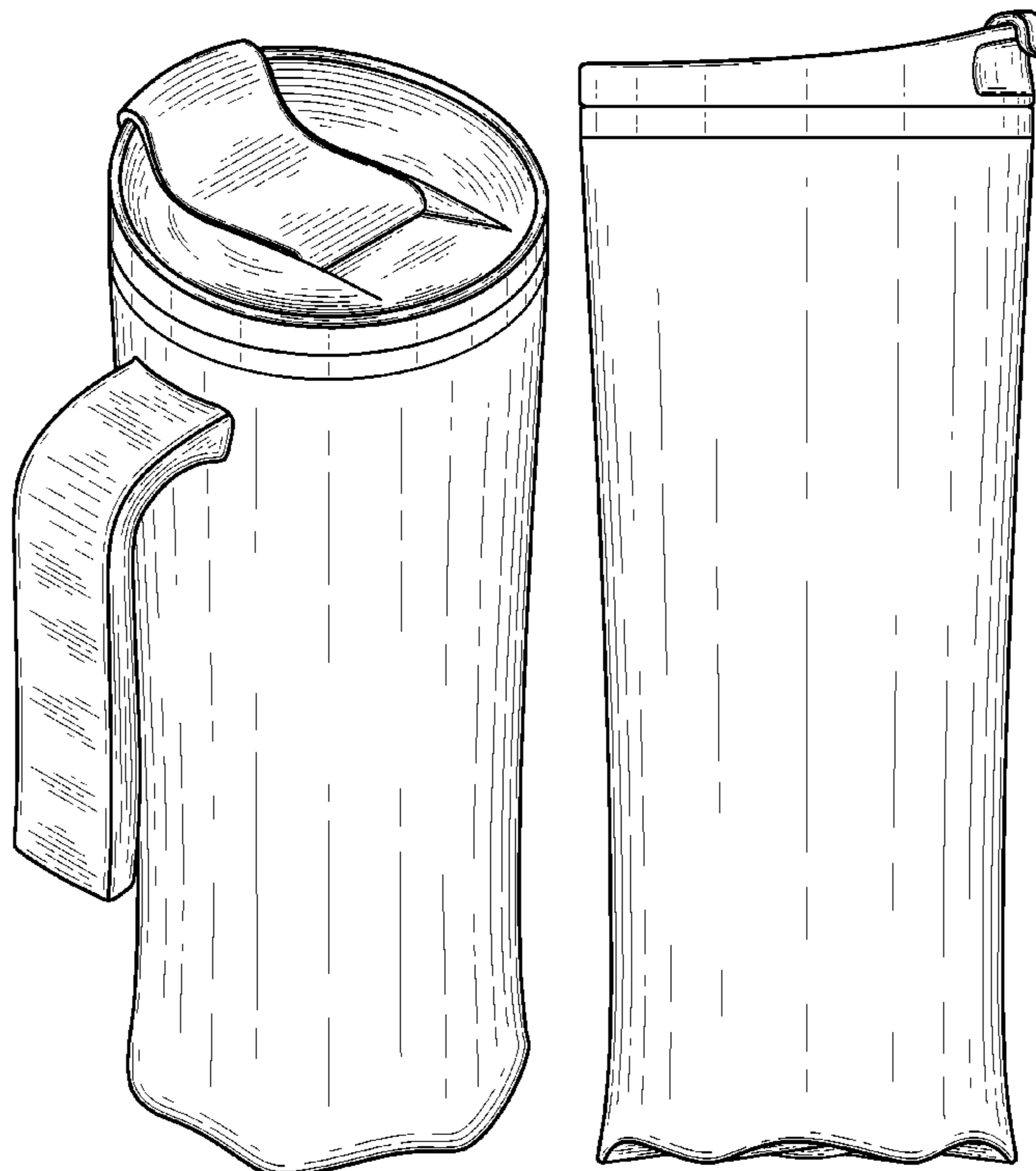
FIG. 12 is a front elevational view thereof.

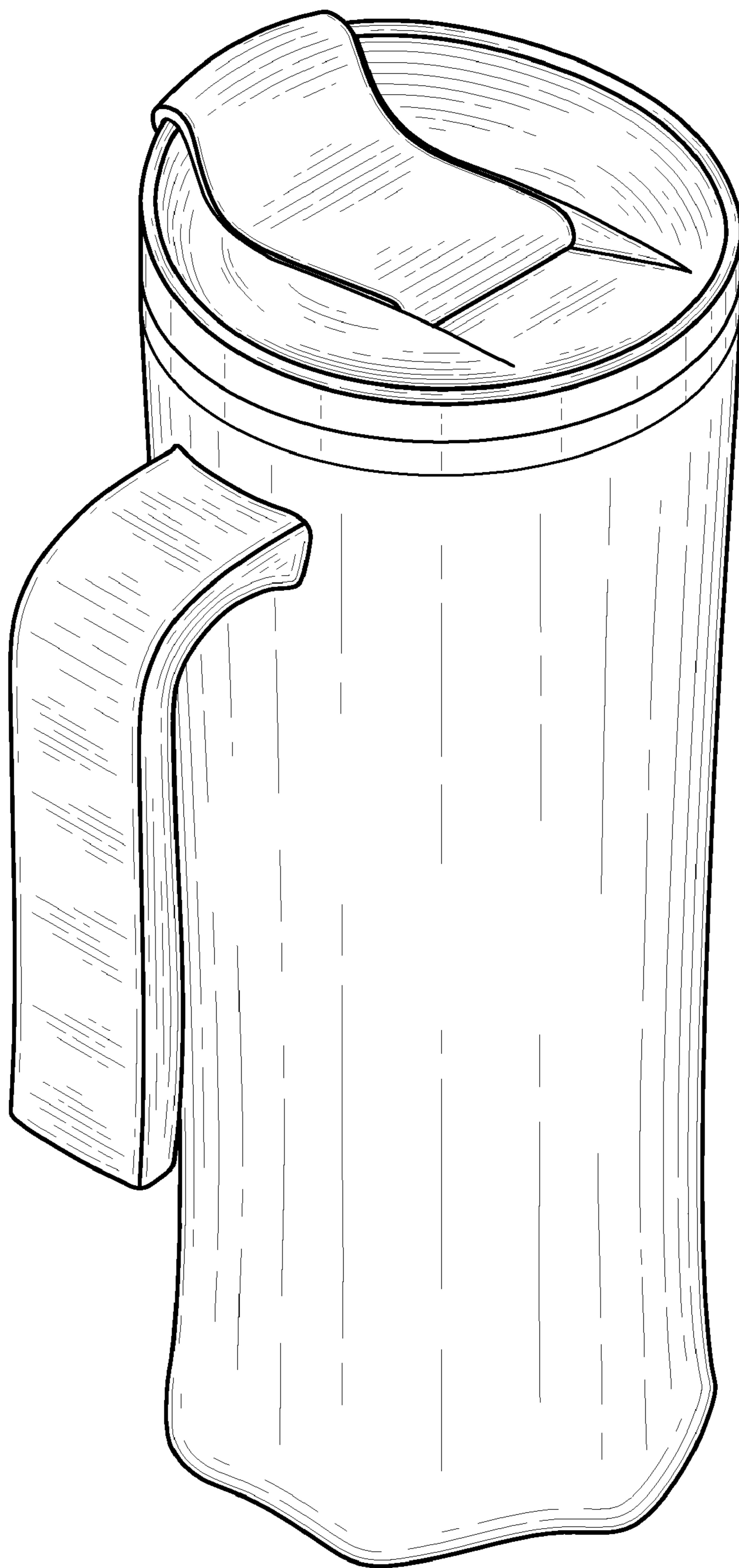
FIG. 13 is a top plan view thereof; and,

FIG. 14 is a bottom plan view thereof.

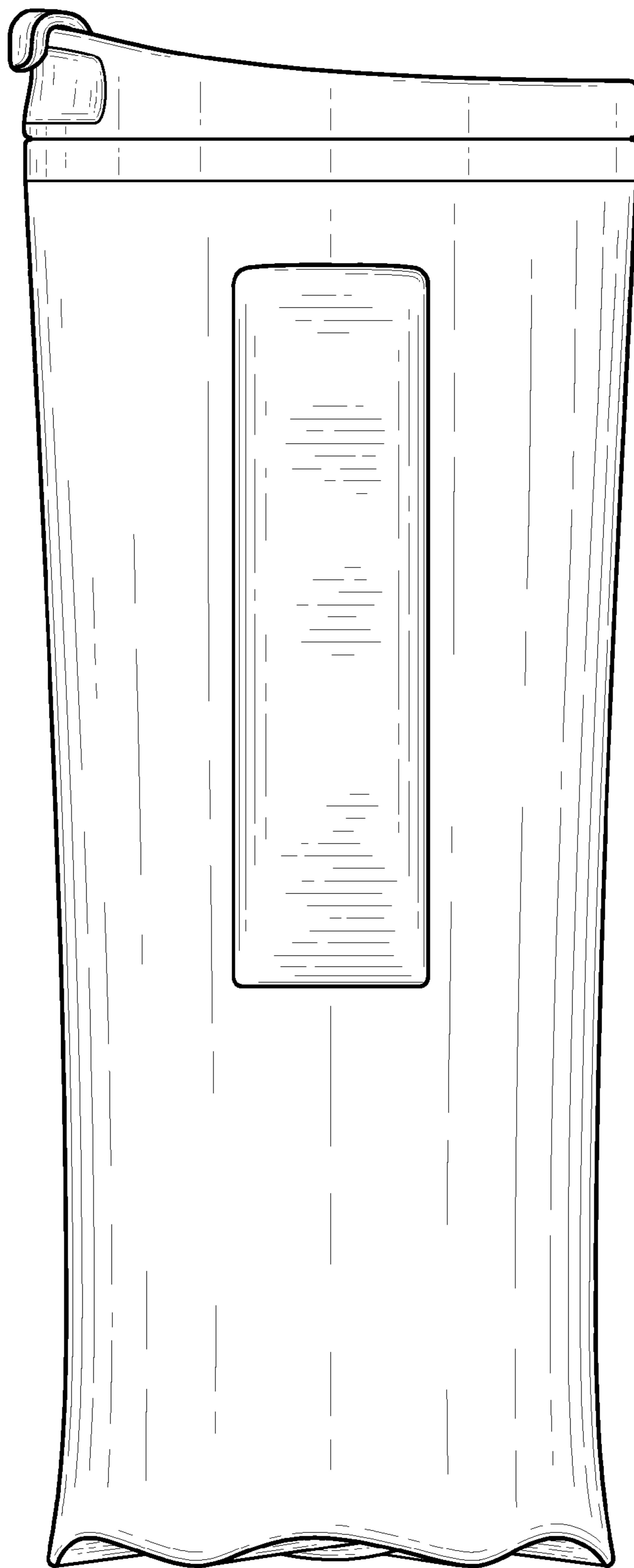
The broken lines are for illustrative purposes only and form no part of the claimed design.

**1 Claim, 12 Drawing Sheets**

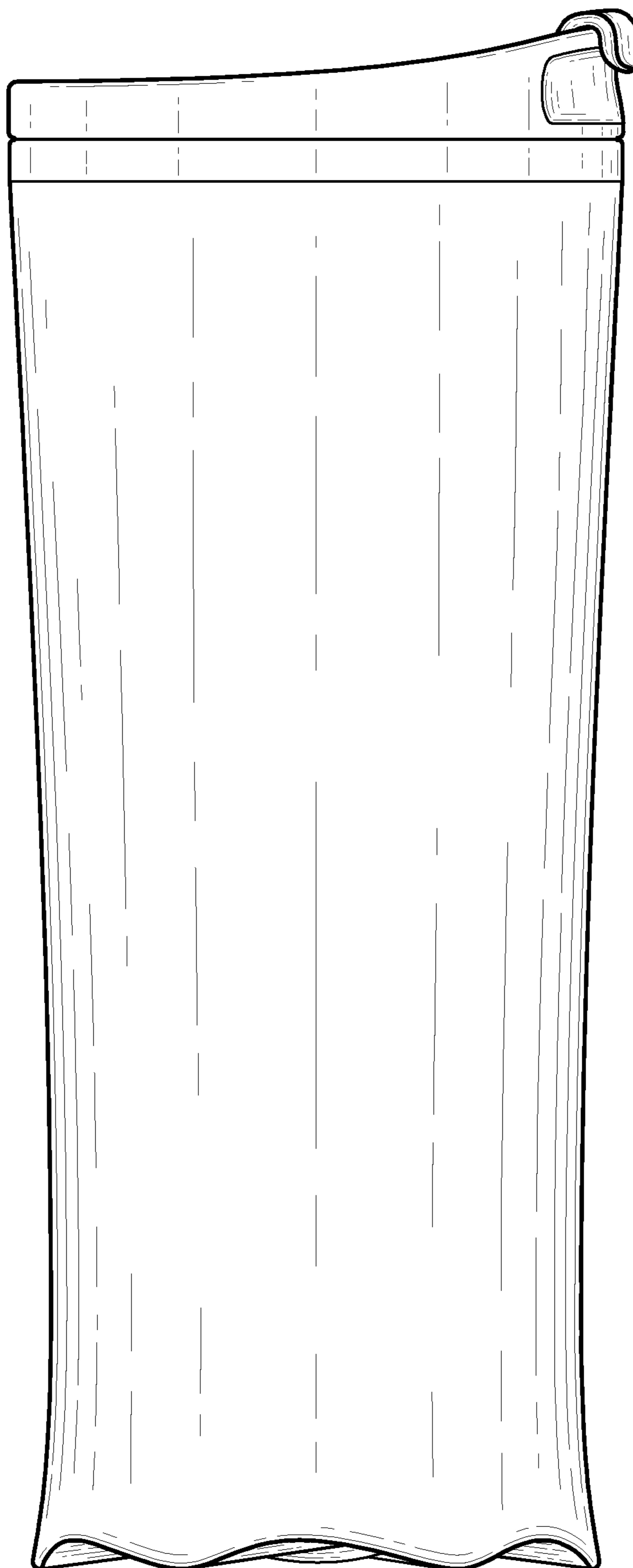




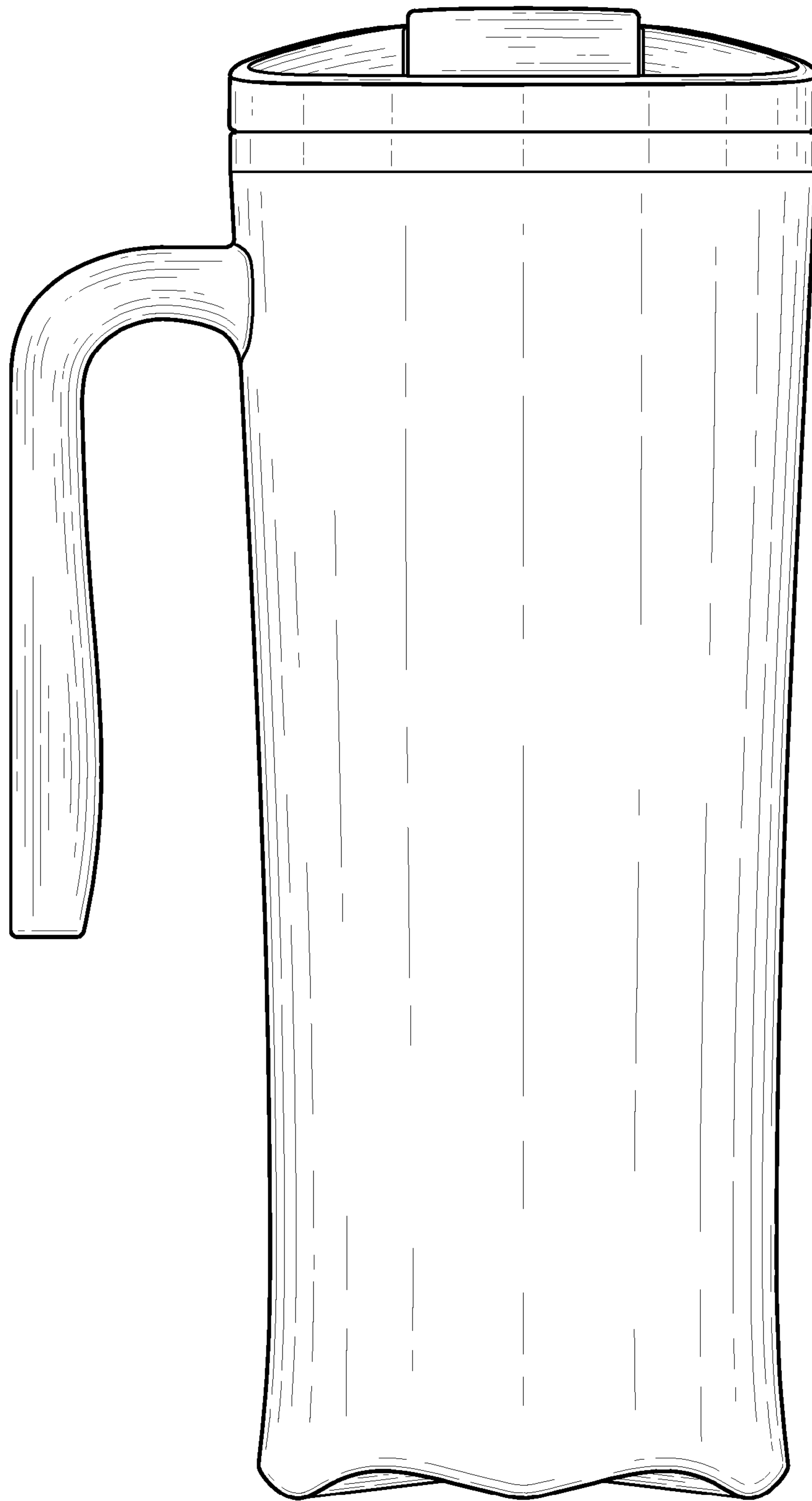
*Fig. 1*



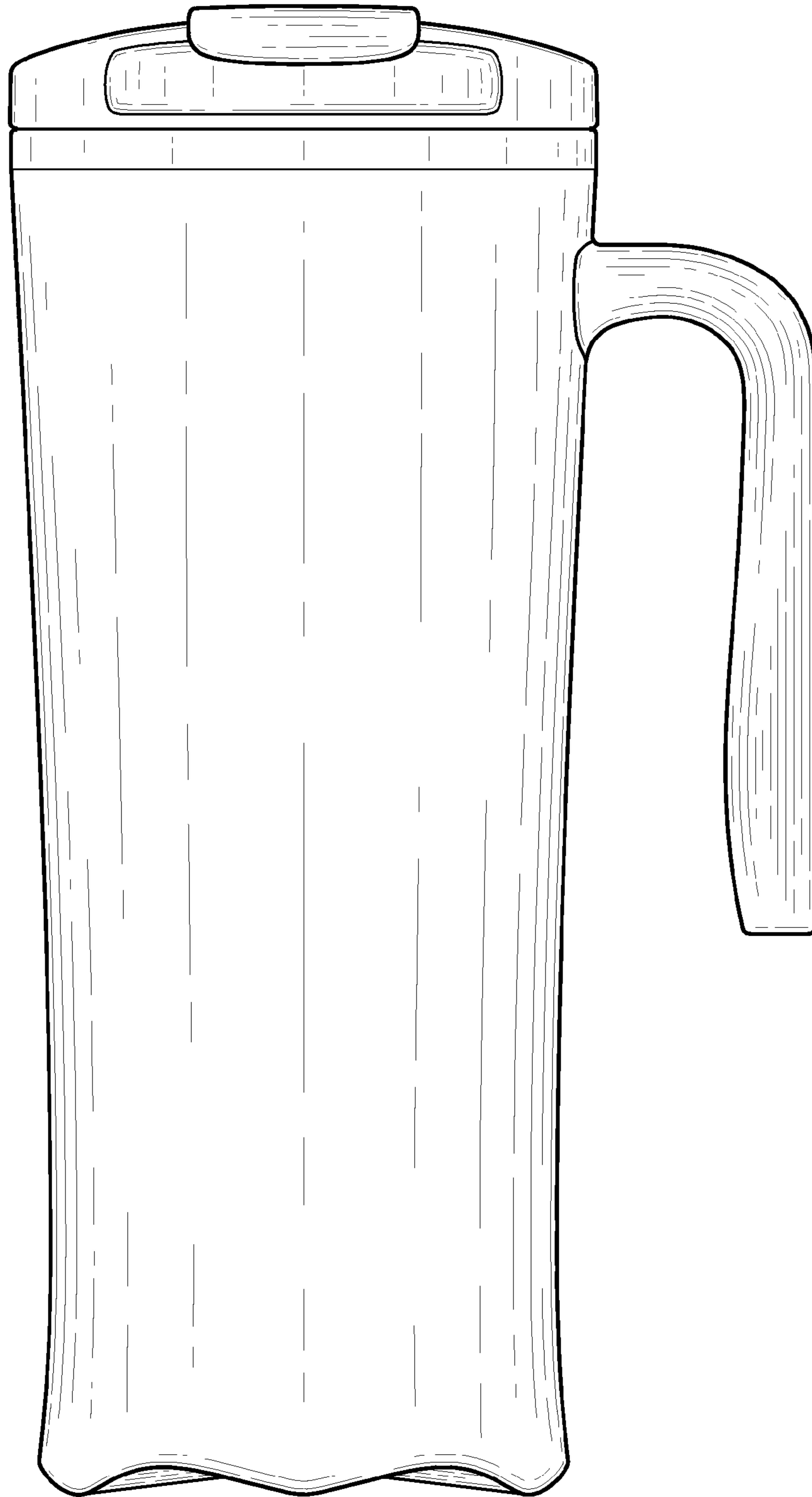
*Fig. 2*



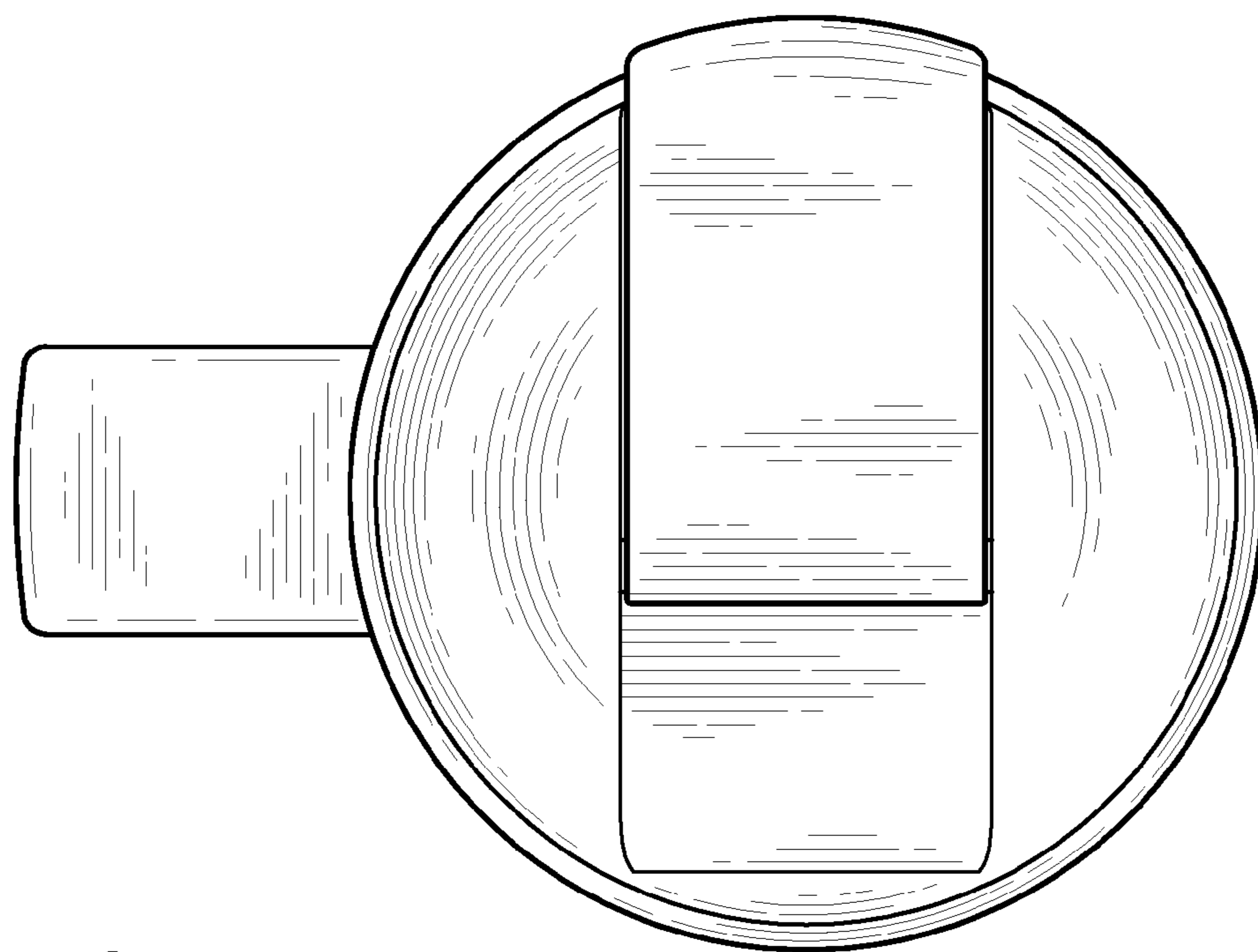
*Fig. 3*



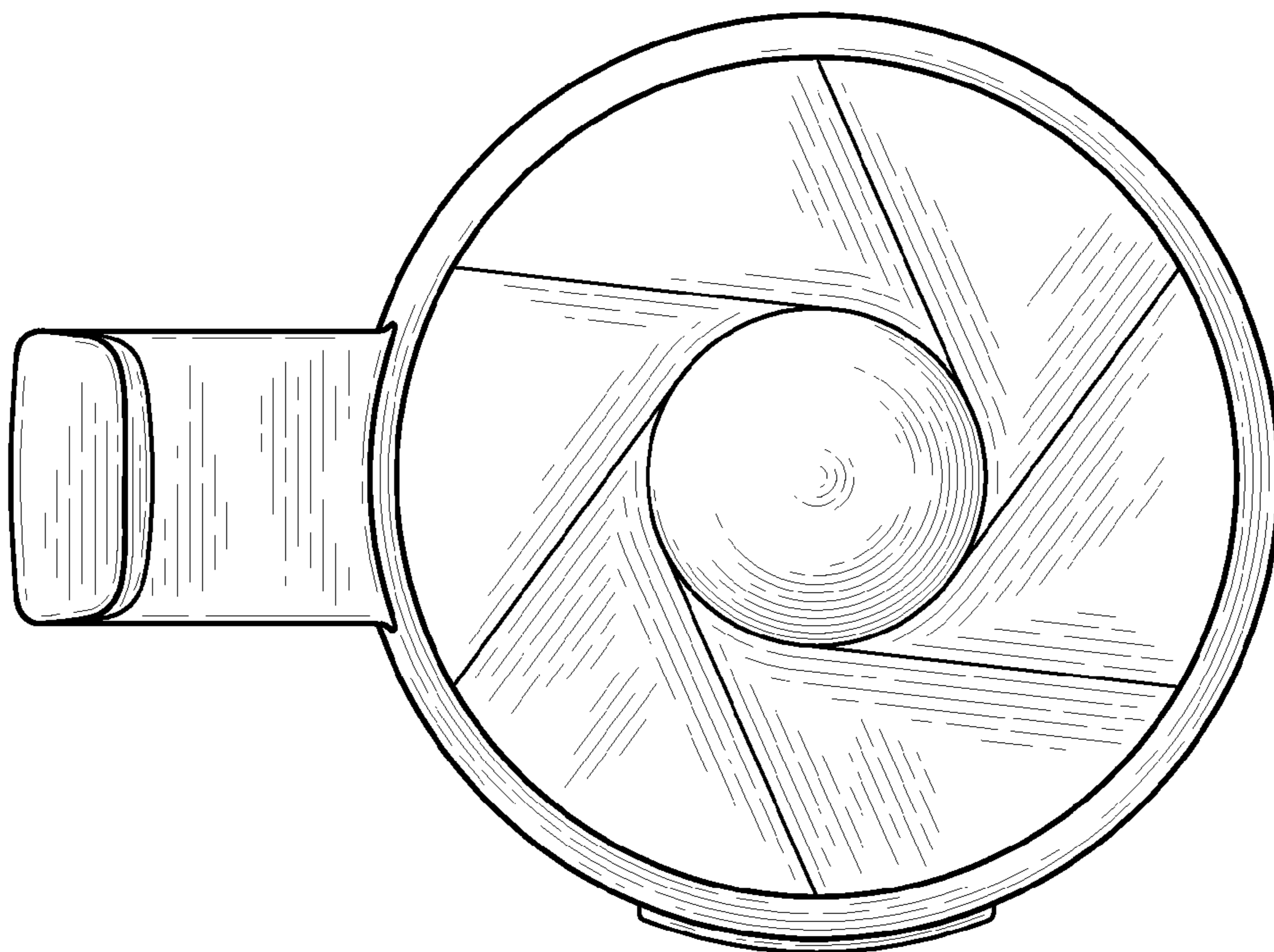
*Fig. 4*



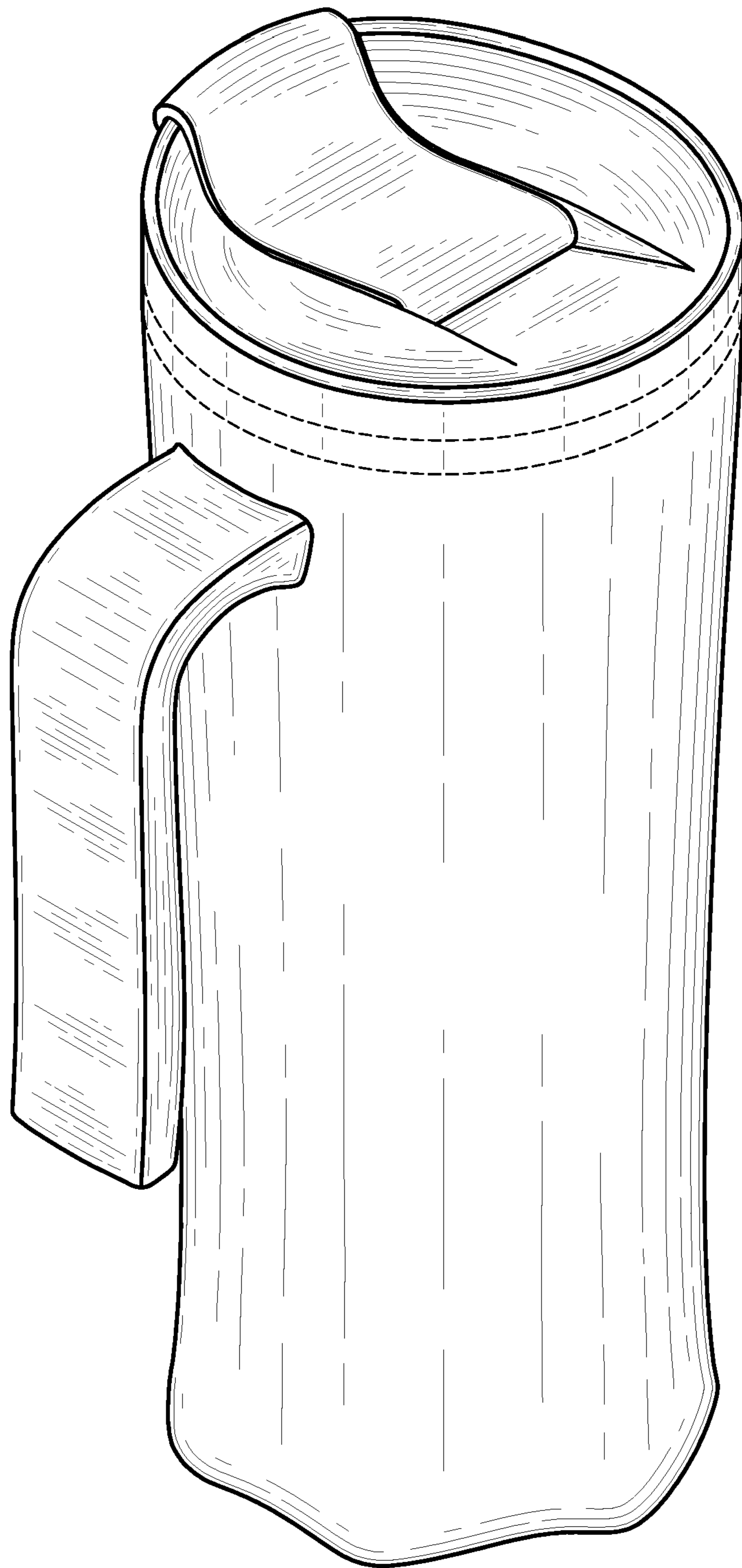
*Fig. 5*



*Fig. 6*

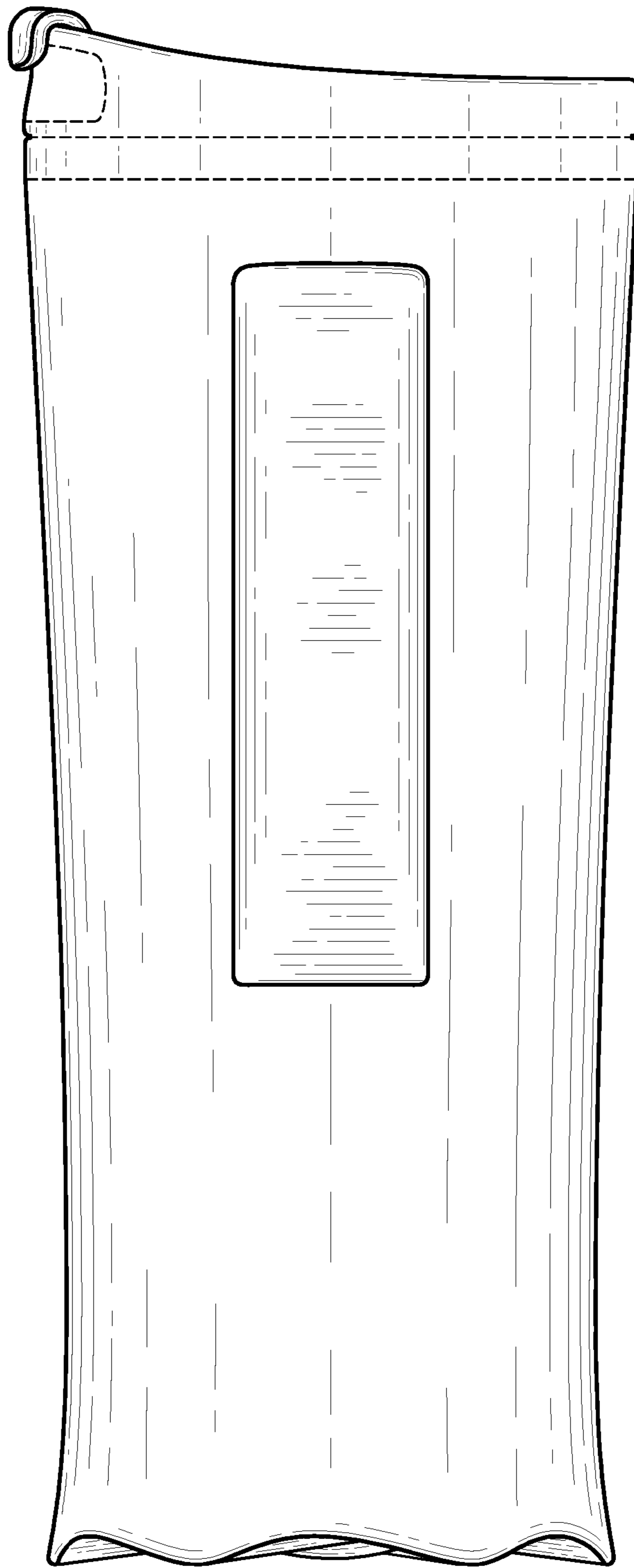


*Fig. 7*

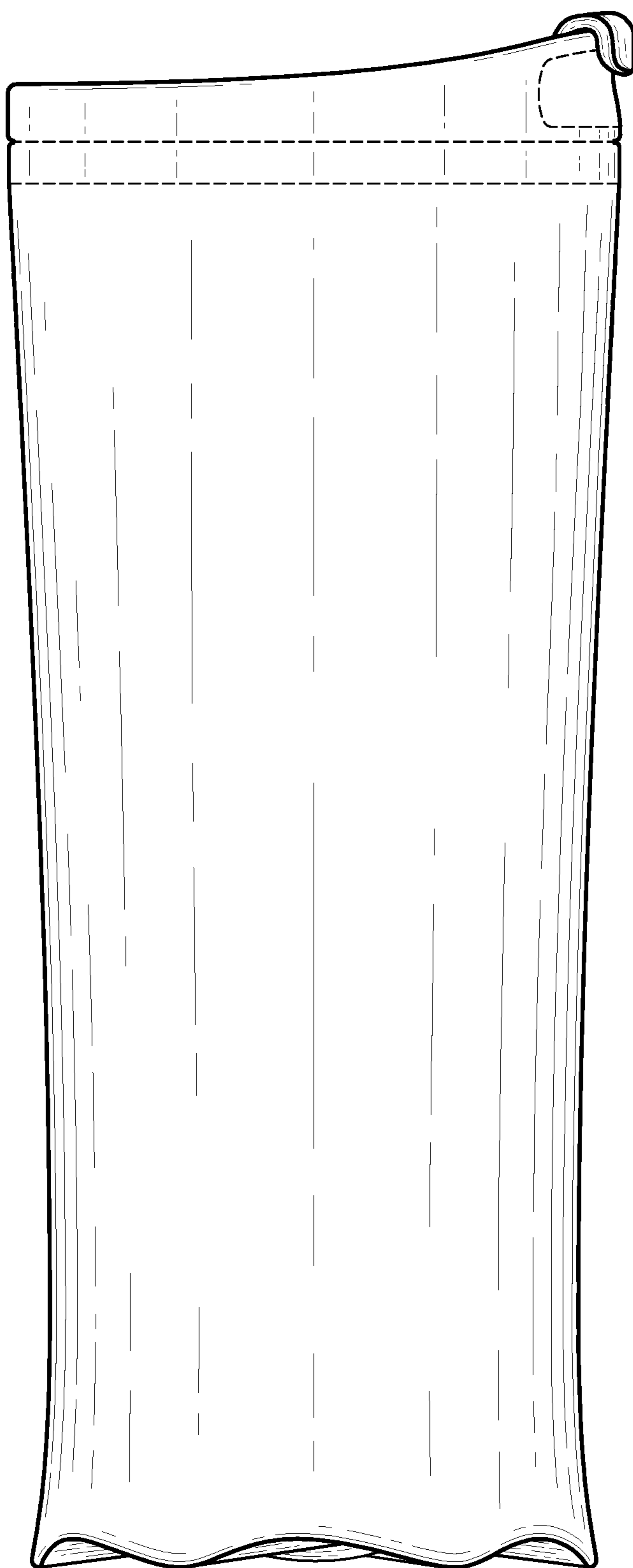


*Fig. 8*

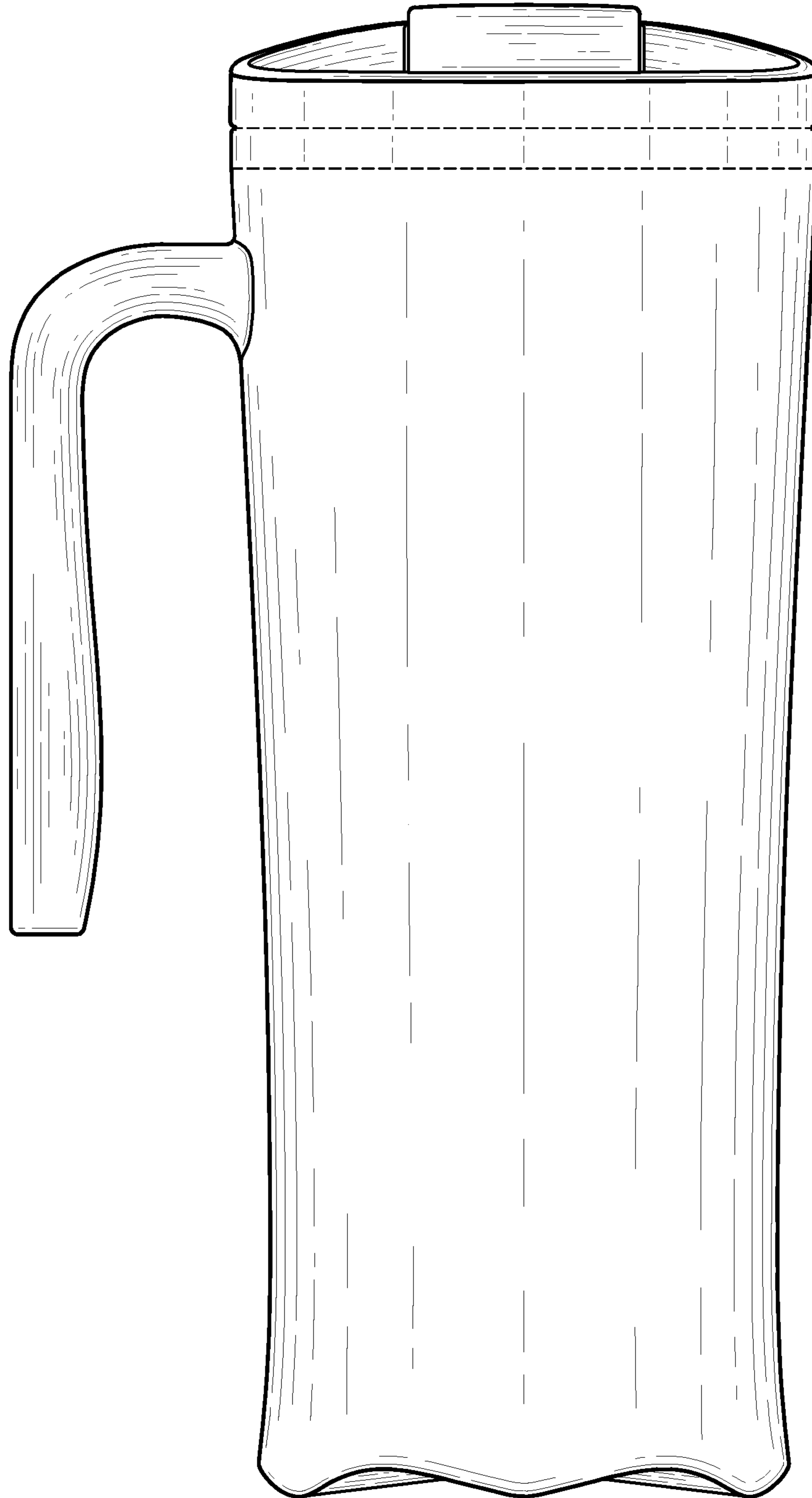




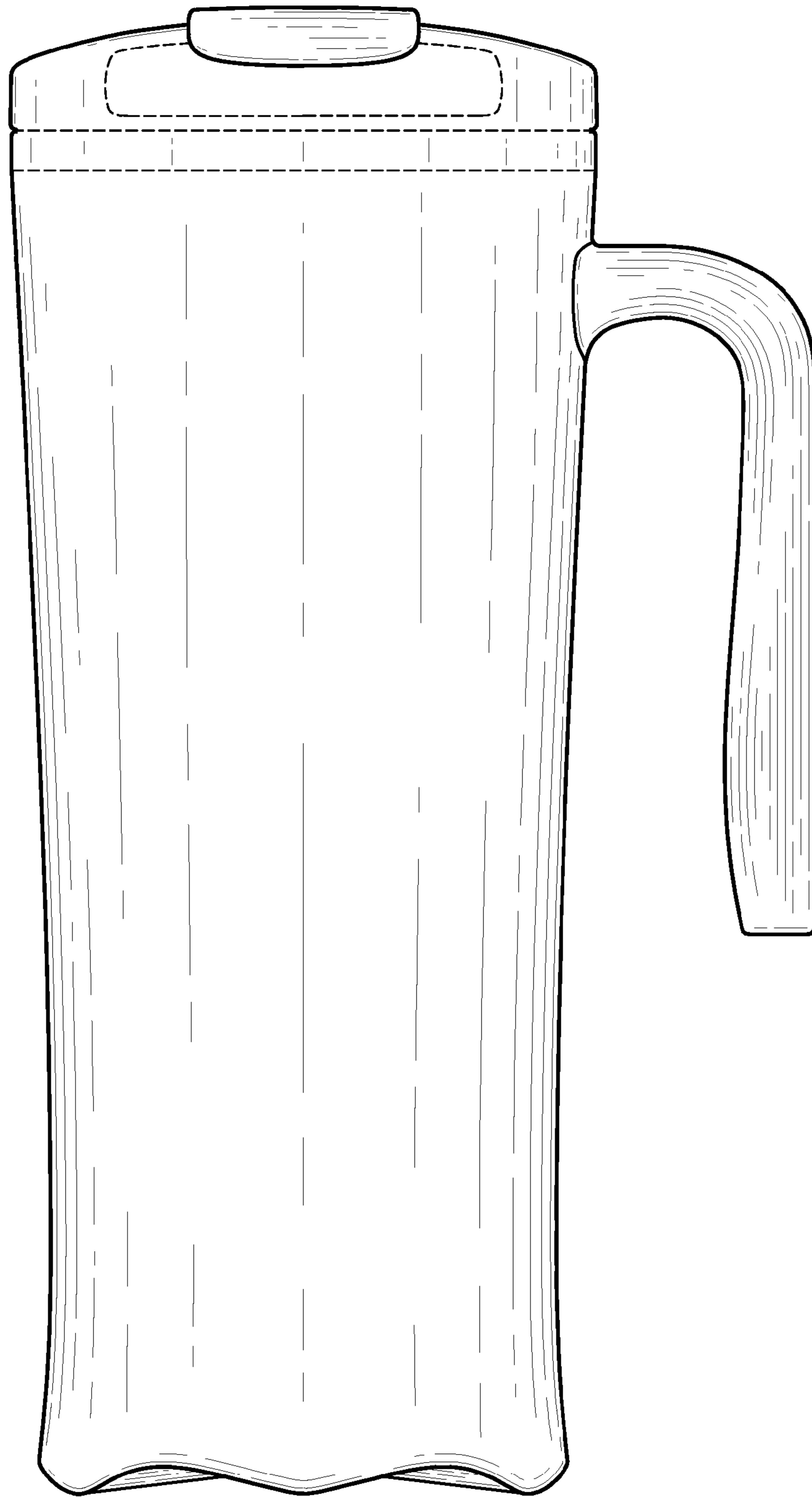
*Fig. 9*



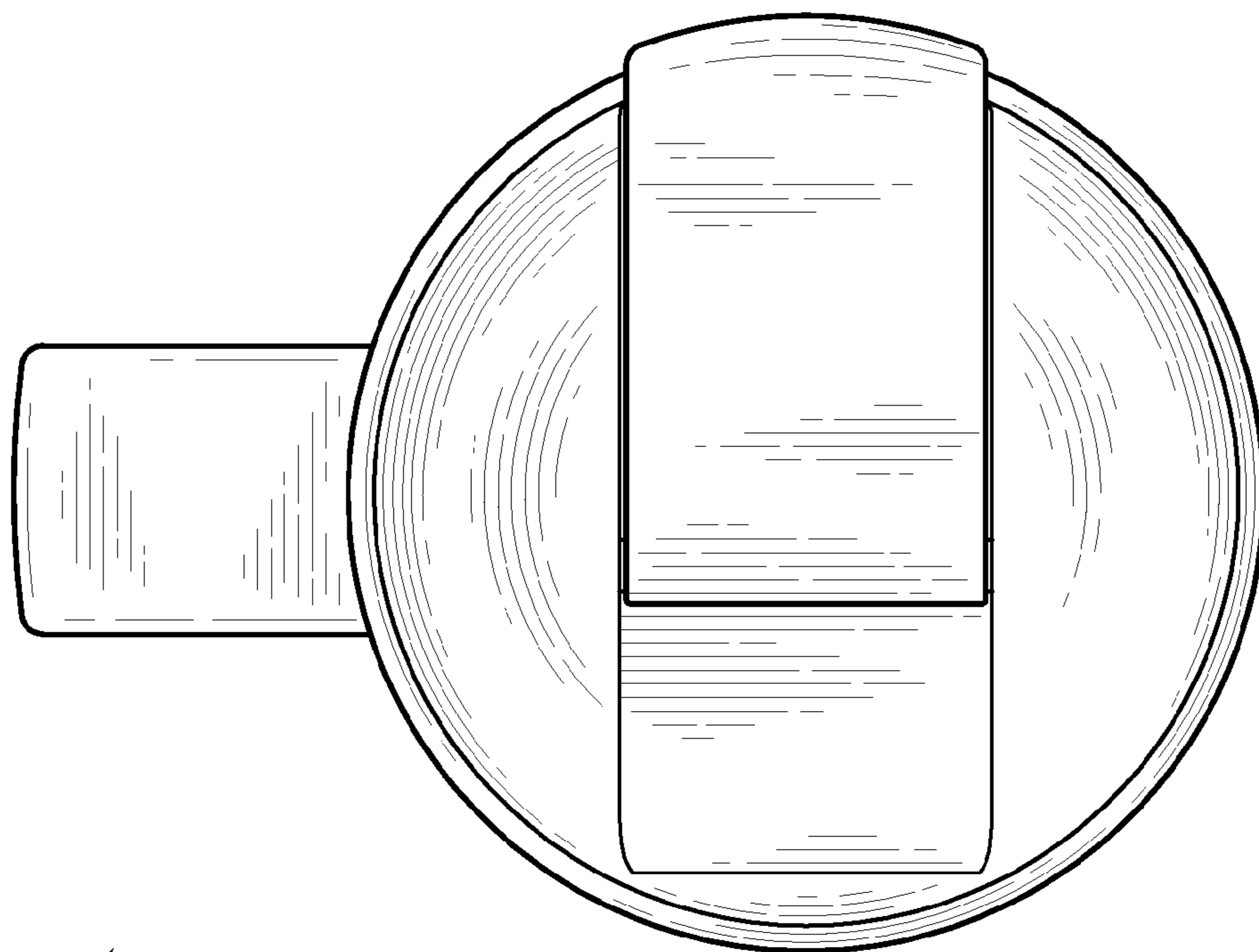
*Fig. 10*



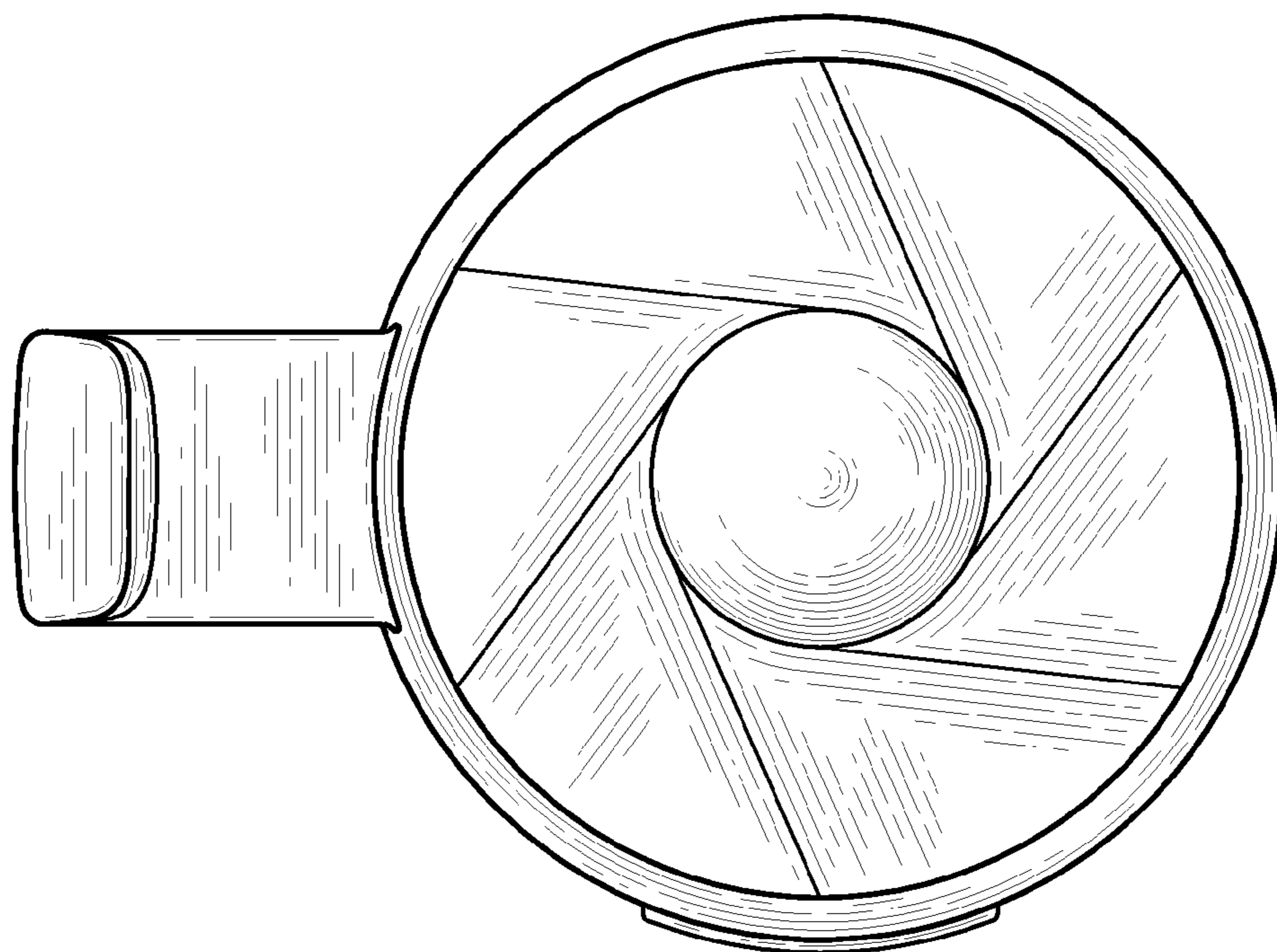
*Fig. 11*



*Fig. 12*



*Fig. 13*



*Fig. 14*