



US00D609931S

(12) **United States Design Patent**  
**Young-il et al.**

(10) **Patent No.:** **US D609,931 S**  
(45) **Date of Patent:** **\*\* Feb. 16, 2010**

(54) **CHAIR**

(75) Inventors: **Ro Young-il**, Seoul (KR); **Karim Rashid**, New York, NY (US)

(73) Assignee: **Yekun Industrial Co., Ltd.** (KR)

(\*\*) Term: **14 Years**

(21) Appl. No.: **29/340,419**

(22) Filed: **Jul. 17, 2009**

(51) **LOC (9) Cl.** ..... **06-01**

(52) **U.S. Cl.** ..... **D6/364; D6/375**

(58) **Field of Classification Search** ..... D6/334,  
D6/335, 336, 355, 361, 364, 365, 375, 376,  
D6/381, 500-502; 297/232, 233, 248, 423.1,  
297/445.1, 451.4, 452.12, 452.19, 452.35  
See application file for complete search history.

(56) **References Cited**

**U.S. PATENT DOCUMENTS**

D87,577 S *	8/1932	Hoey	.....	D6/355
D87,578 S *	8/1932	Hoey	.....	D6/355
D227,201 S *	6/1973	Scott	.....	D6/365
D230,922 S *	3/1974	Lewis	.....	D6/364
3,827,750 A *	8/1974	Fantoni	.....	297/451.4
D270,501 S *	9/1983	Olko	.....	D6/361
D355,981 S *	3/1995	Kim	.....	D6/336
D366,571 S *	1/1996	Hutton	.....	D6/361

D508,787 S *	8/2005	Natuzzi	.....	D6/364
D508,790 S *	8/2005	Natuzzi	.....	D6/364
D508,791 S *	8/2005	Natuzzi	.....	D6/364
D509,371 S *	9/2005	Natuzzi	.....	D6/361

\* cited by examiner

*Primary Examiner*—Mimosa De

(74) *Attorney, Agent, or Firm*—Rader, Fishman & Grauer PLLC

(57) **CLAIM**

The ornamental design for a chair, as shown and described.

**DESCRIPTION**

FIG. 1 is a perspective view of a chair.

FIG. 2 is a front view of a chair.

FIG. 3 is a back view of a chair.

FIG. 4 is a left side view of a chair.

FIG. 5 is a right side view of a chair.

FIG. 6 is a top view of a chair.

FIG. 7 is a bottom view of a chair; and,

FIG. 8 is a perspective view showing two chairs and two intermediate pieces disposed between the two chairs.

The broken lines shown FIG. 8 is for illustrative purposes only and form no part of the claimed design.

**1 Claim, 5 Drawing Sheets**







*FIG. 1*



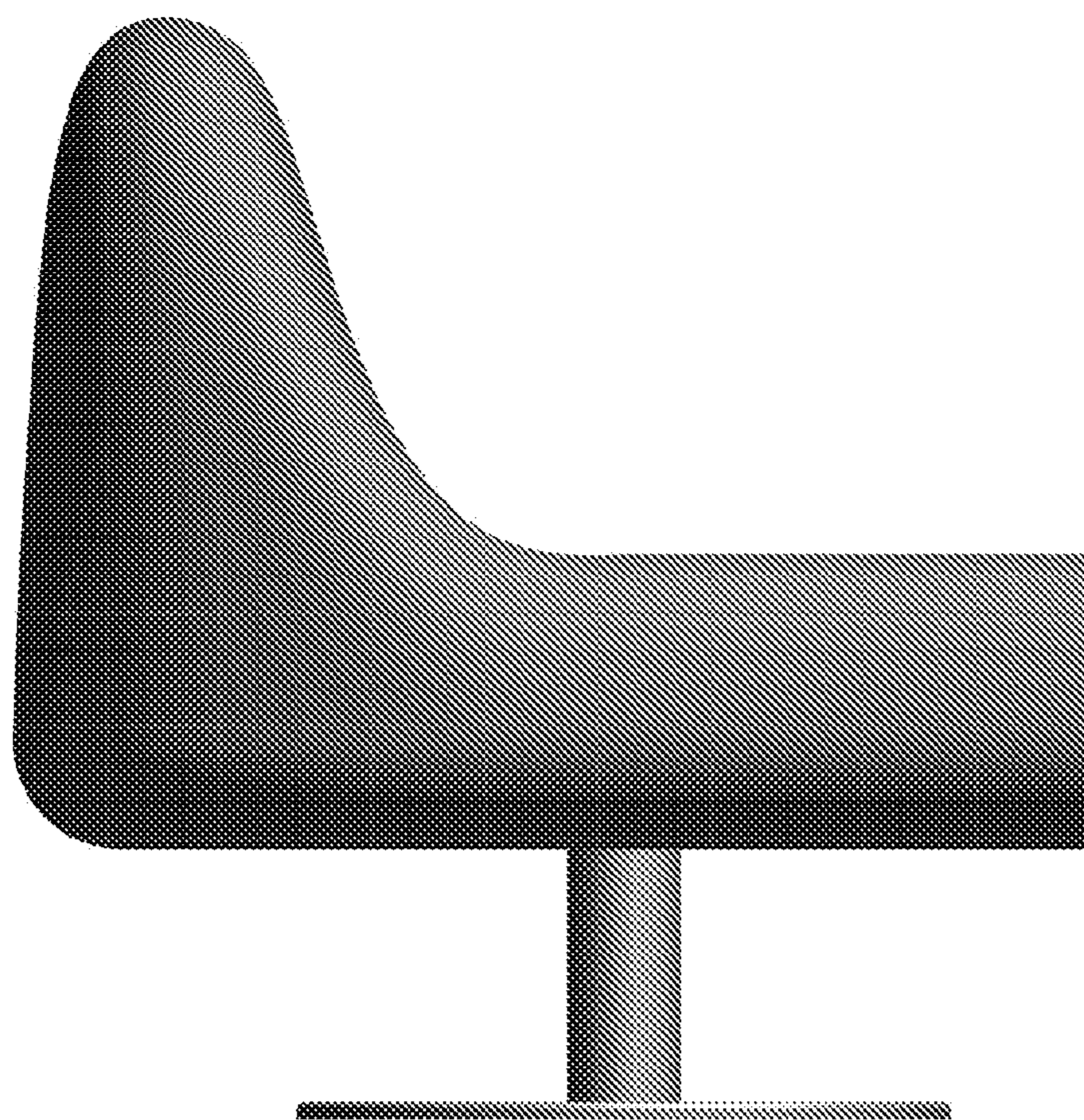

FIG. 2

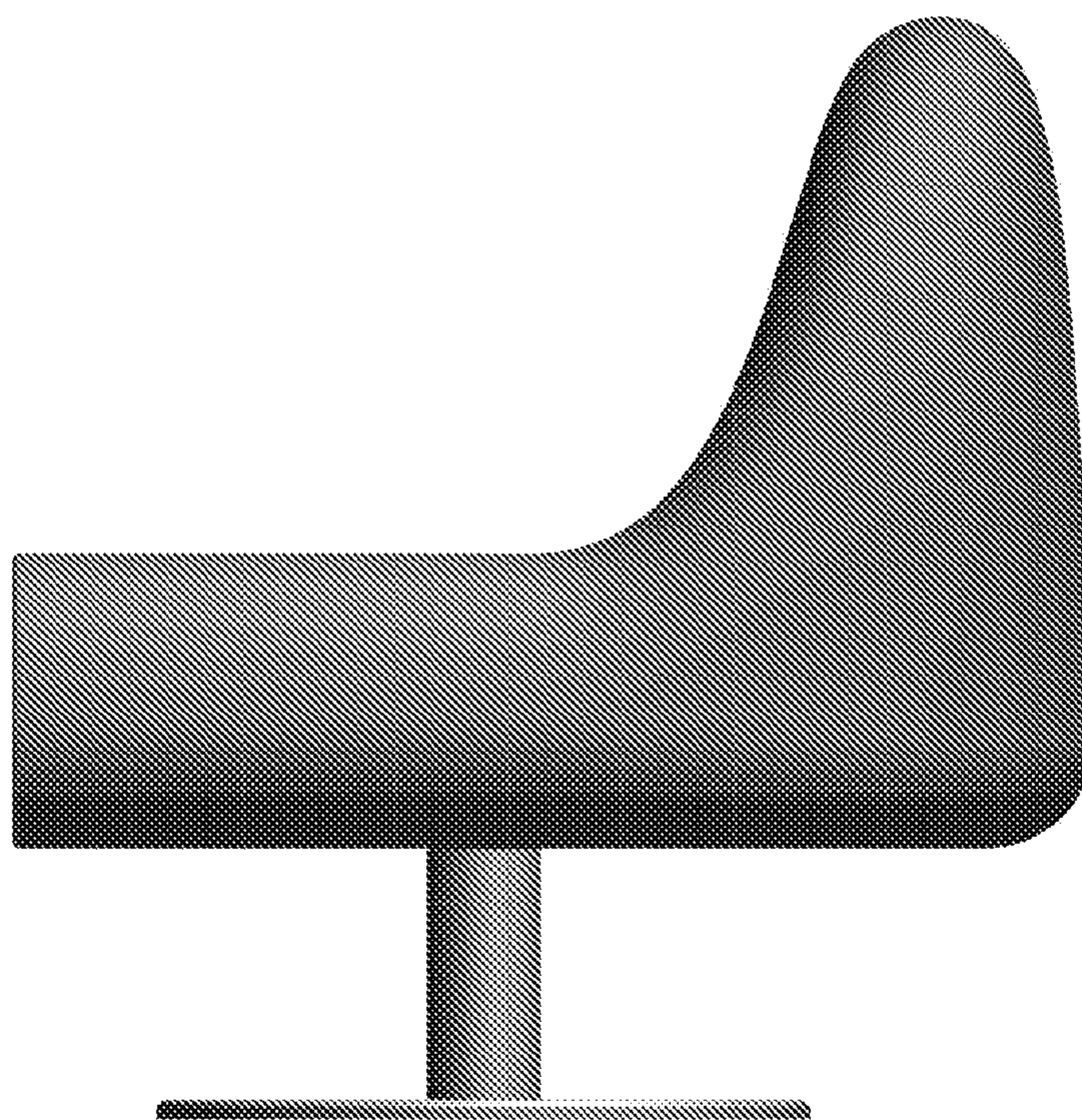

FIG. 3



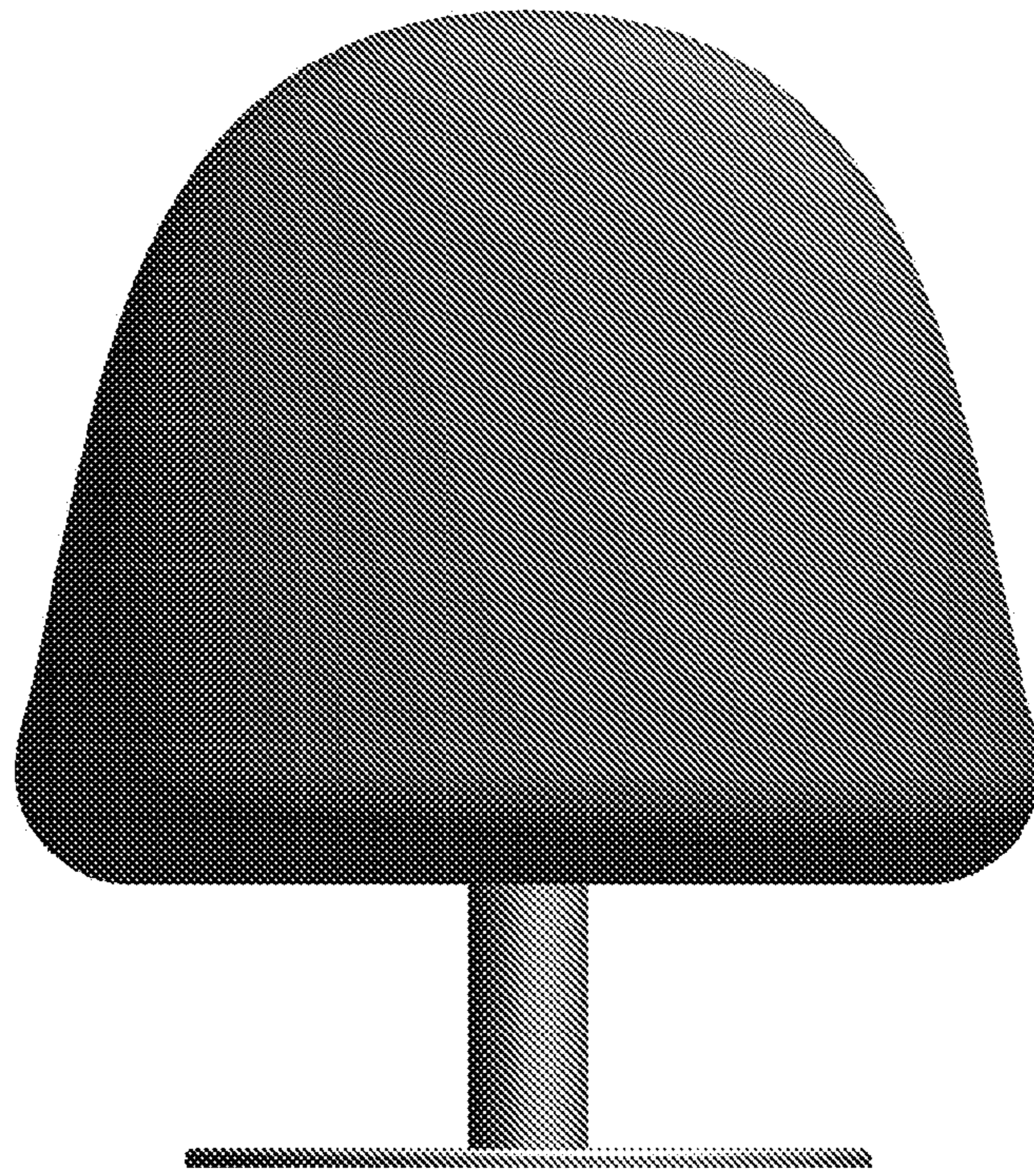

FIG. 4

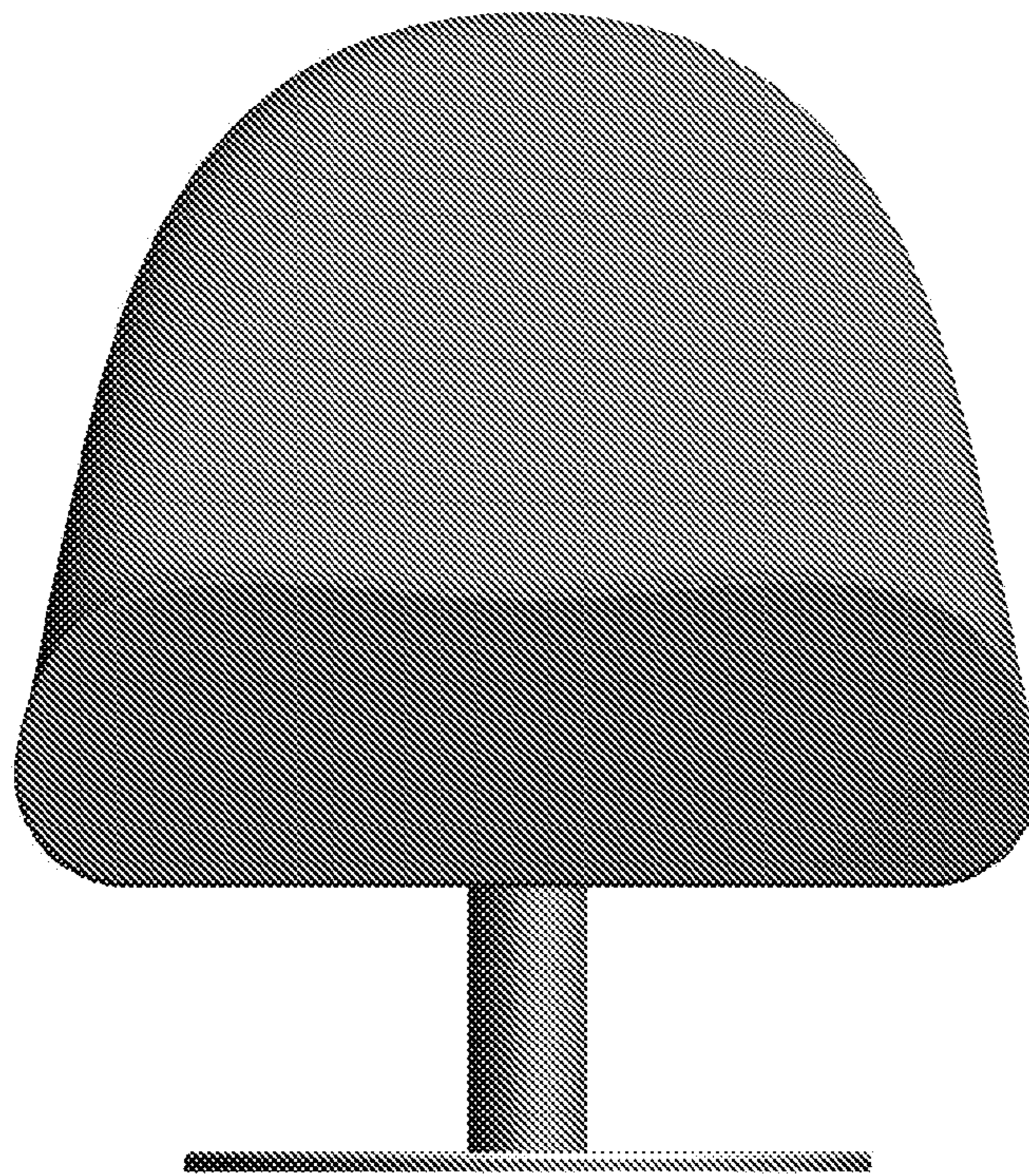
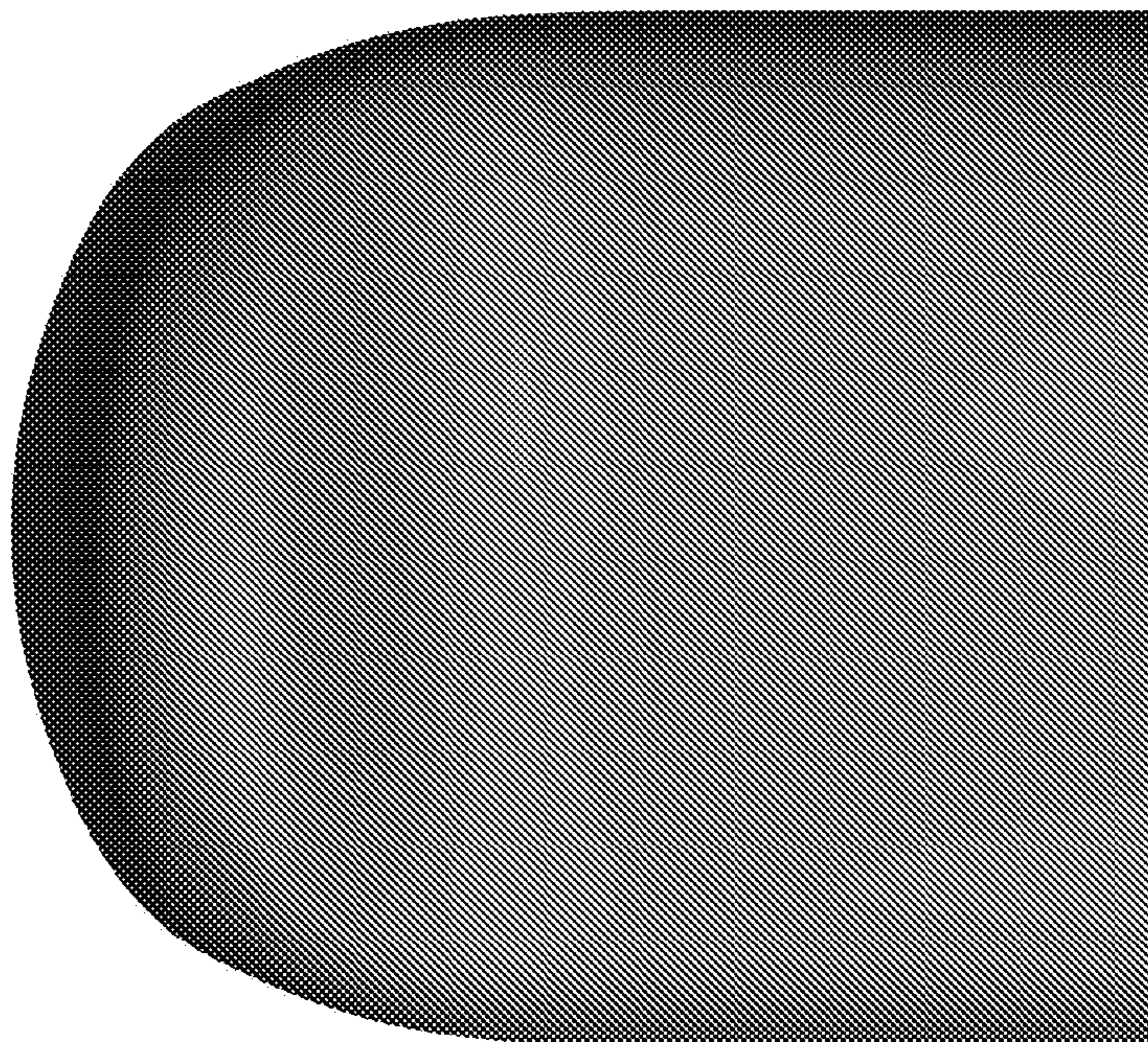
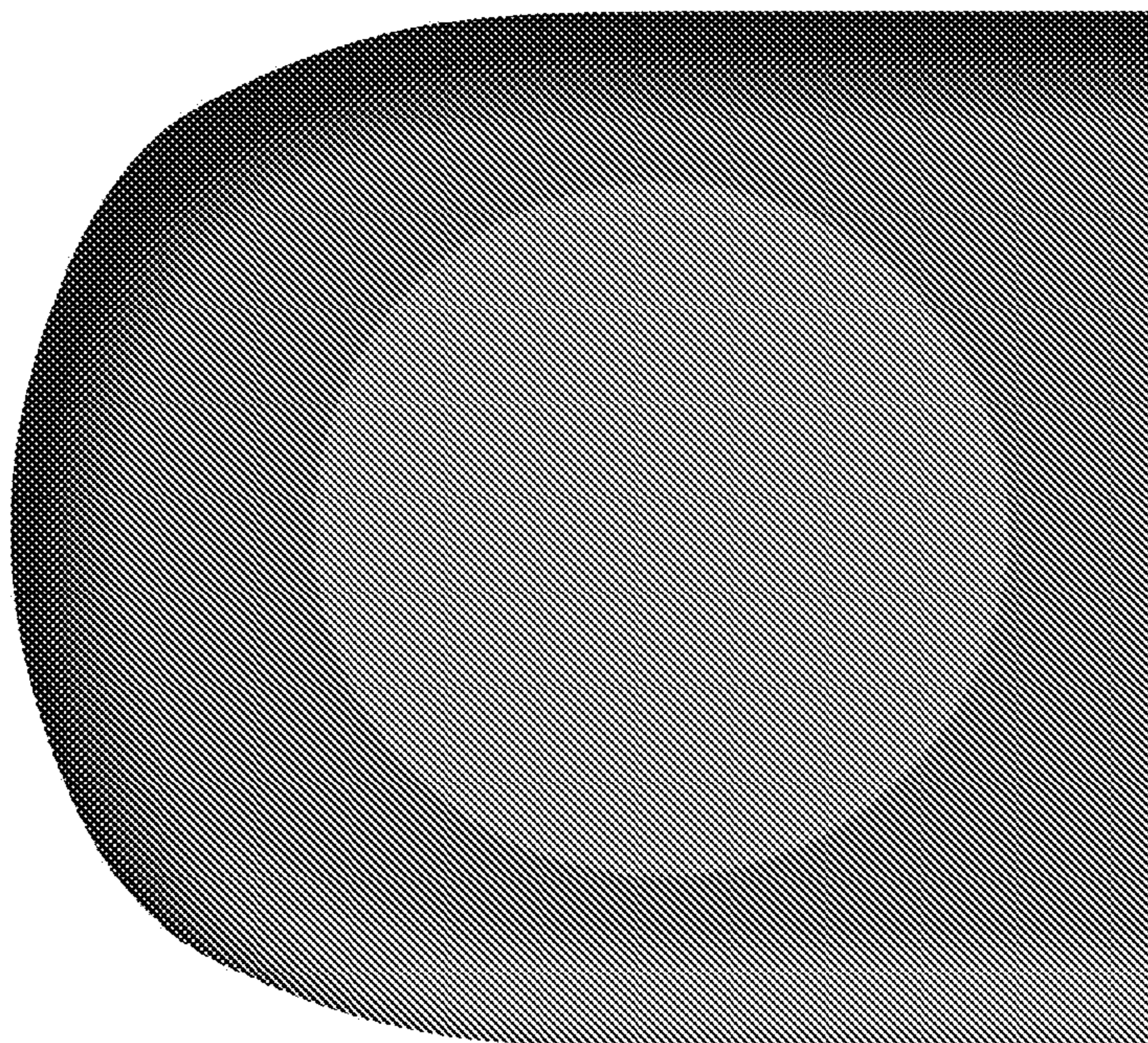

FIG. 5





*FIG. 6*



*FIG. 7*



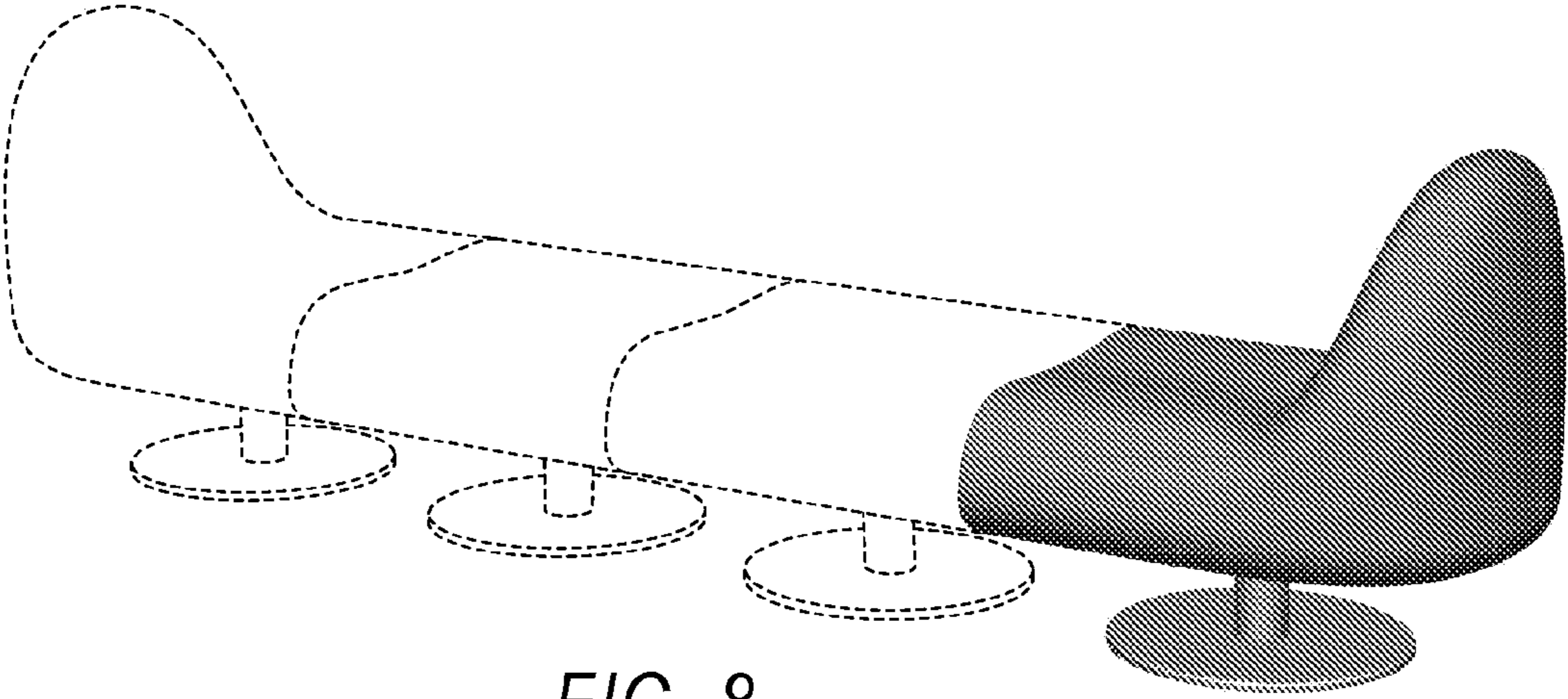

FIG. 8