



US00D609901S

(12) **United States Design Patent**
Behar et al.

(10) **Patent No.:** **US D609,901 S**
(45) **Date of Patent:** **** Feb. 16, 2010**

(54) **FABRIC CASE CARRY ACCESSORY FOR A MOBILE PHONE DEVICE**

D550,955 S * 9/2007 Boyd et al. D3/218
D559,532 S * 1/2008 Kwak et al. D3/218
D591,499 S * 5/2009 Ross, III D3/218

(75) Inventors: **Yves Albert Behar**, San Francisco, CA (US); **Qin Li**, South San Francisco, CA (US); **Emmanuel Laffon de Mazieres**, San Francisco, CA (US)

* cited by examiner

Primary Examiner—Catherine R Oliver
(74) *Attorney, Agent, or Firm*—Townsend and Townsend and Crew LLP

(73) Assignee: **ALIPHCOM**, San Francisco, CA (US)

(**) Term: **14 Years**

(57) **CLAIM**

(21) Appl. No.: **29/333,427**

The ornamental design for a fabric case carry accessory for a mobile phone device, as shown and described.

(22) Filed: **Mar. 9, 2009**

DESCRIPTION

(51) **LOC (9) Cl.** **03-01**

FIG. 1 is a perspective view of a fabric case carry accessory for a mobile phone device showing our new design;

(52) **U.S. Cl.** **D3/218**

FIG. 2 is a front elevational view thereof;

(58) **Field of Classification Search** D3/218,
D3/219, 215, 226, 228, 230, 299, 303; 224/236,
224/240, 267, 675–677, 666, 669, 904, 914;
206/305, 320; 379/446, 449, 455, 457; D14/250–251,
D14/496; 455/90, 92

FIG. 3 is a rear elevational view thereof;

FIG. 4 is a left side elevational view thereof;

FIG. 5 is a right side elevational view thereof;

See application file for complete search history.

FIG. 6 is a top plan view thereof;

FIG. 7 is a bottom plan view thereof; and,

(56) **References Cited**

FIG. 8 depicts a rear perspective view of the fabric case carry accessory for a mobile phone device, while carrying a headset.

U.S. PATENT DOCUMENTS

D329,749 S * 9/1992 Scheid D3/218
D339,690 S * 9/1993 Takahashi et al. D3/218
D348,355 S * 7/1994 Scheid et al. D3/218
D390,699 S * 2/1998 Goldenberg et al. D3/218
D507,872 S * 8/2005 Watson D3/218
D533,341 S * 12/2006 Infanti et al. D3/218

The broken lines shown in the drawings form no part of the claimed design.

1 Claim, 5 Drawing Sheets

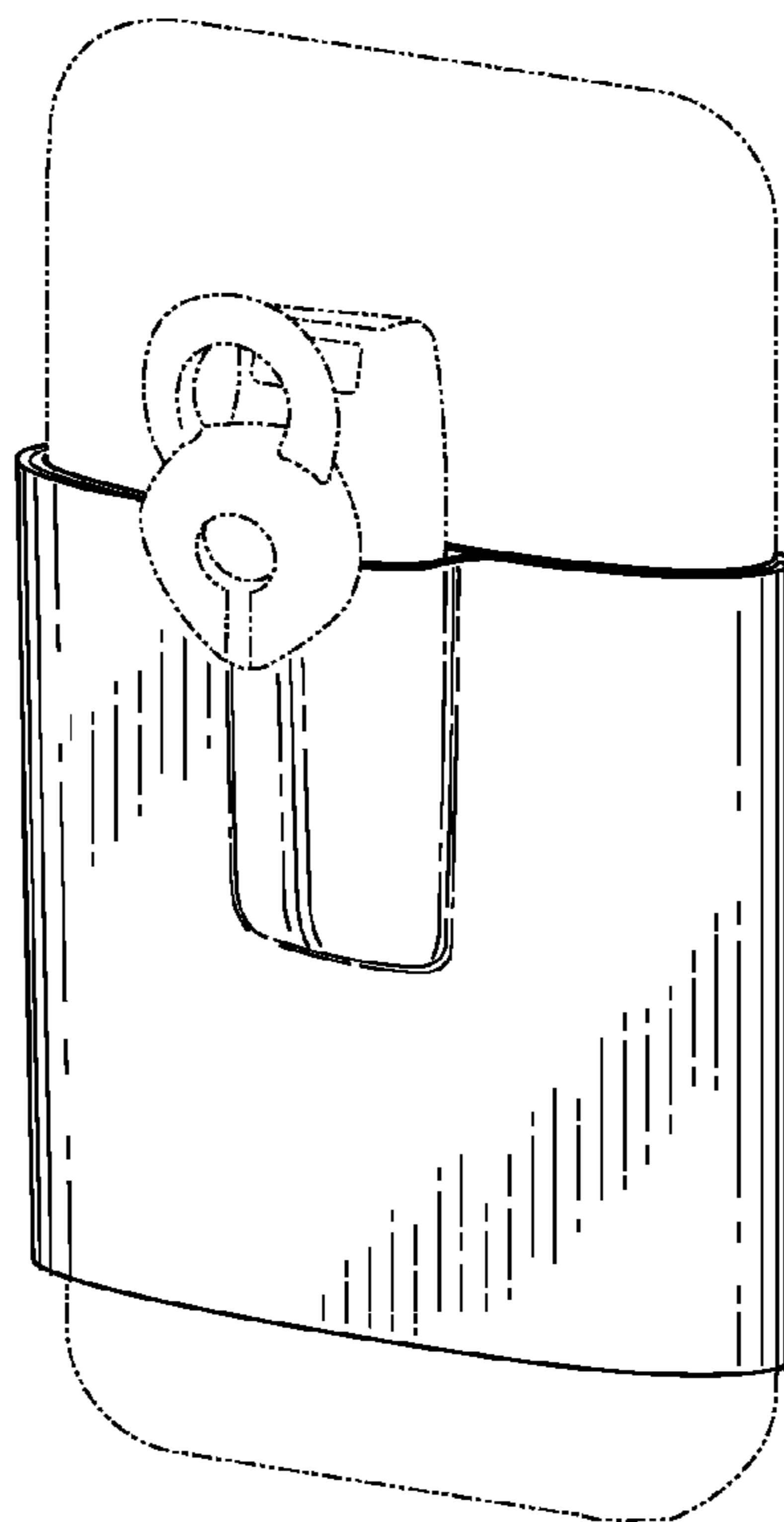

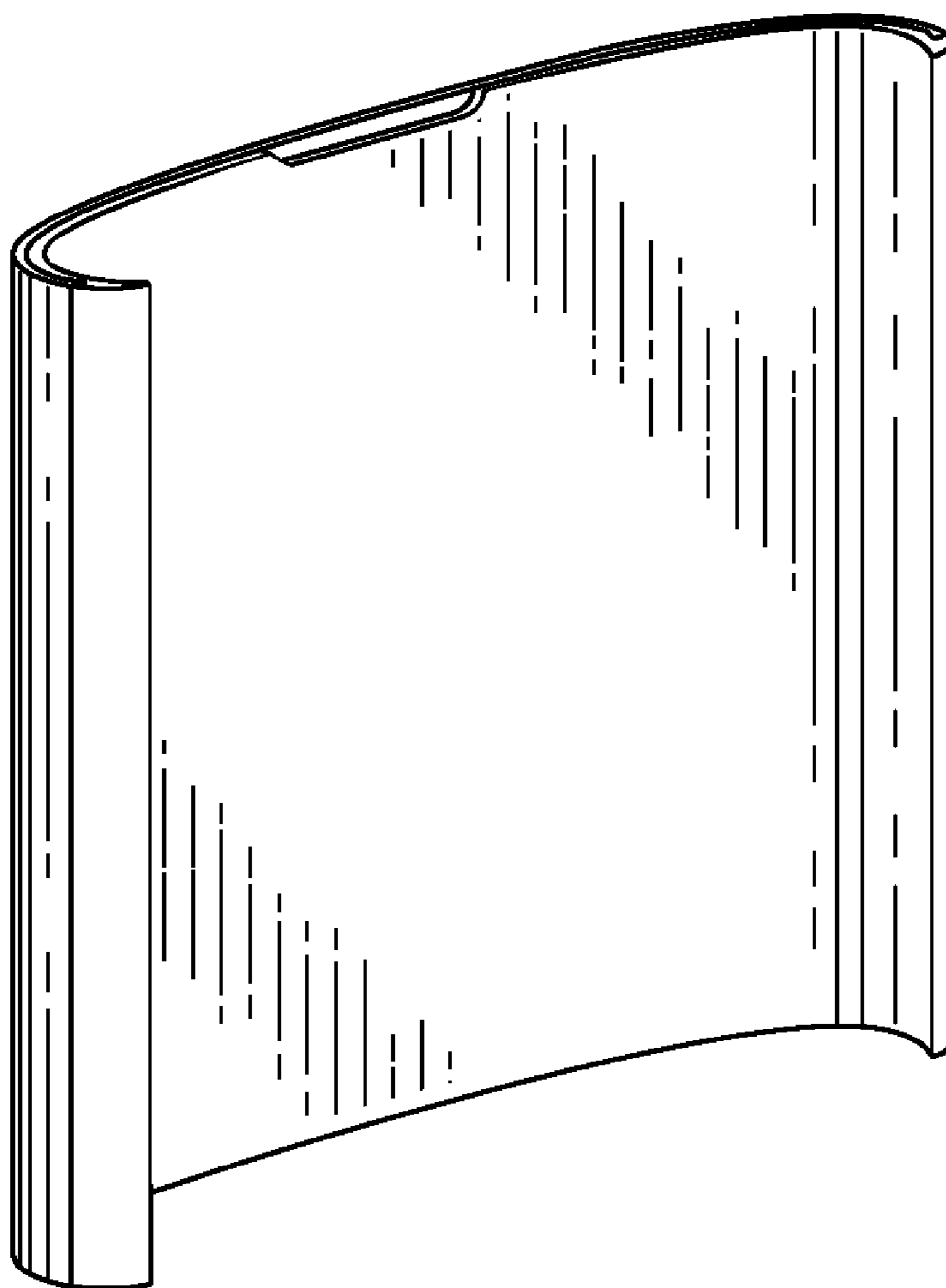

FIG. 1

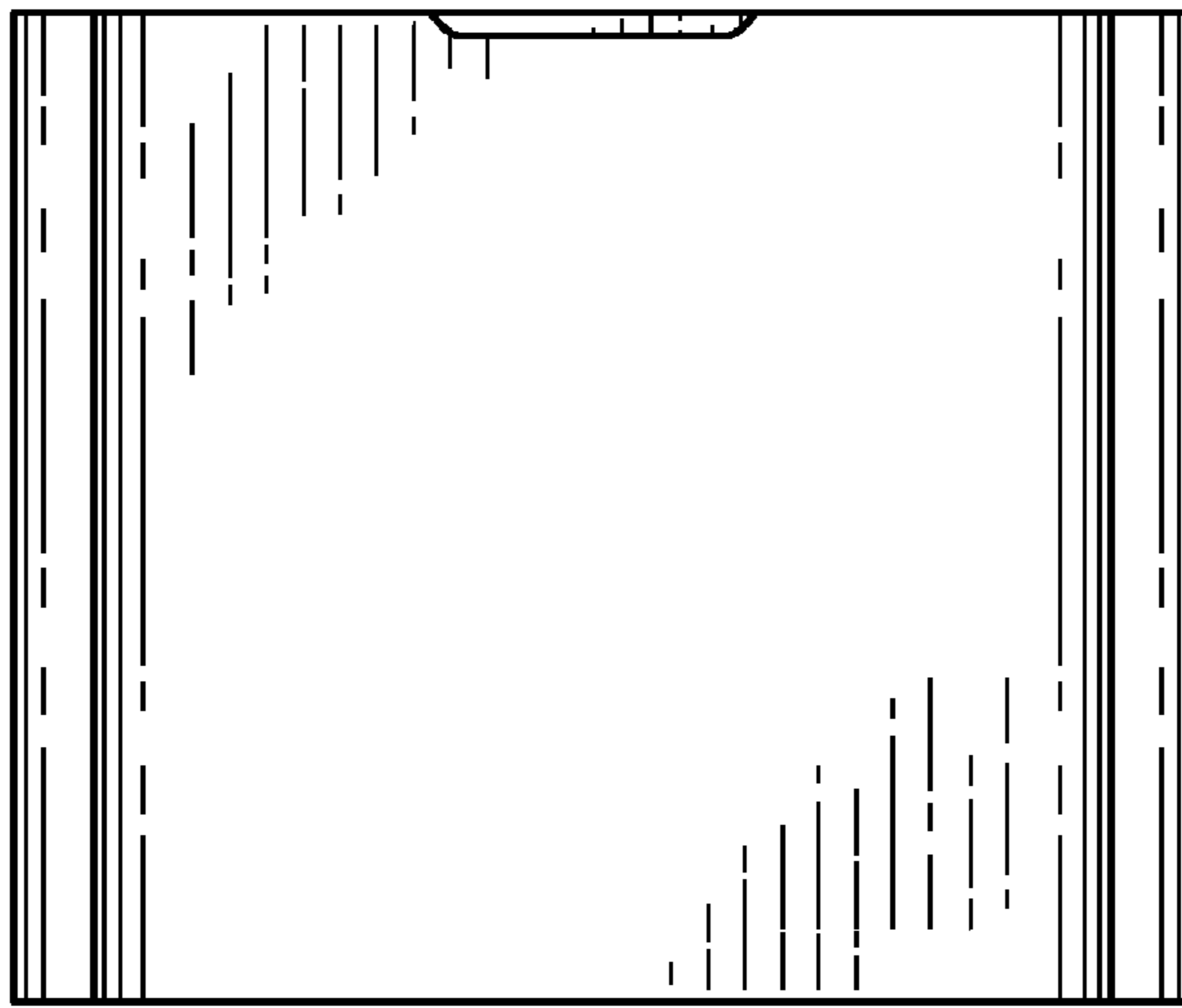

FIG. 2

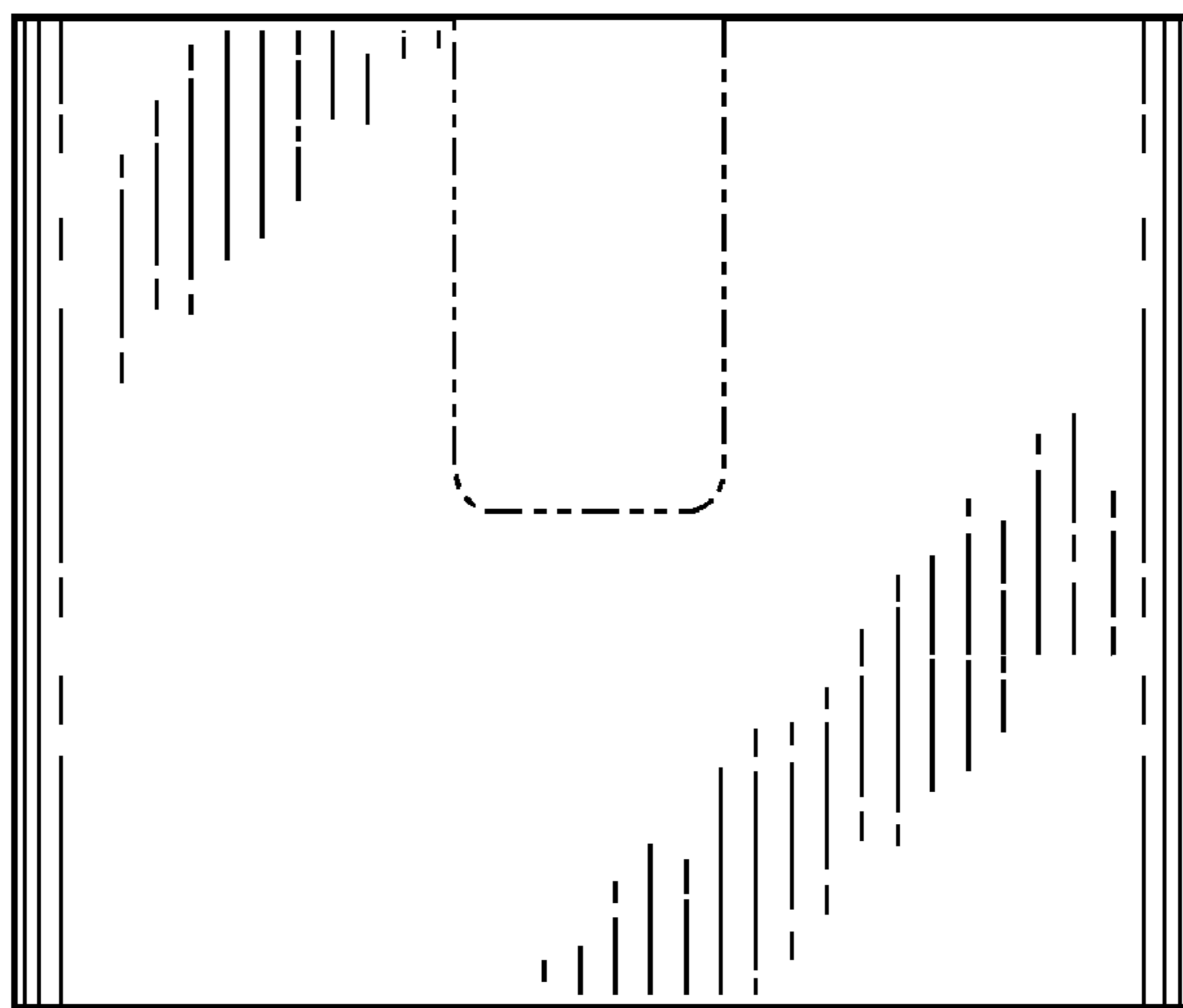

FIG. 3

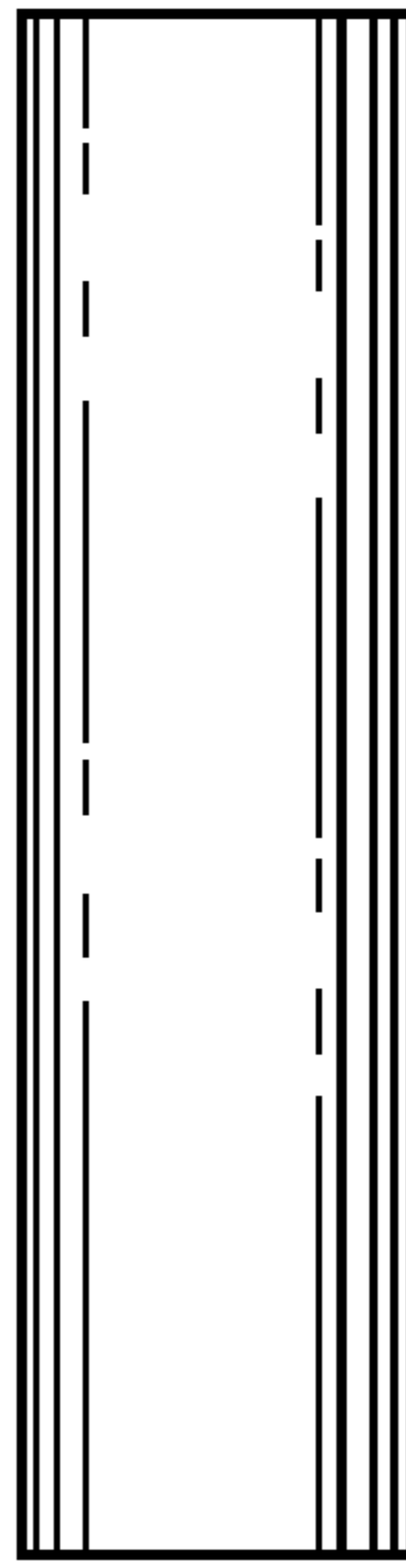

FIG. 4

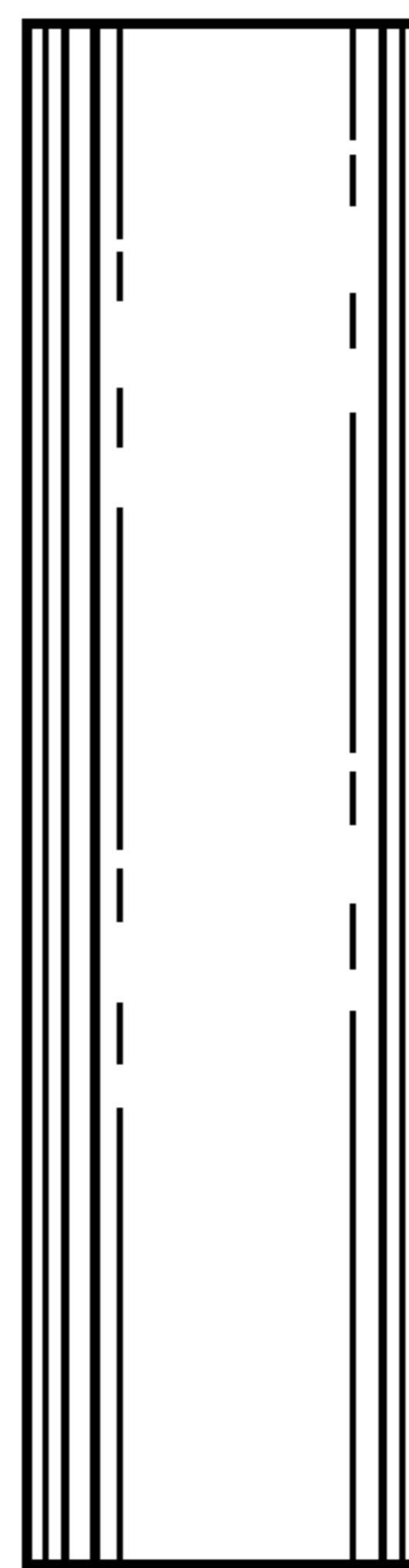

FIG. 5

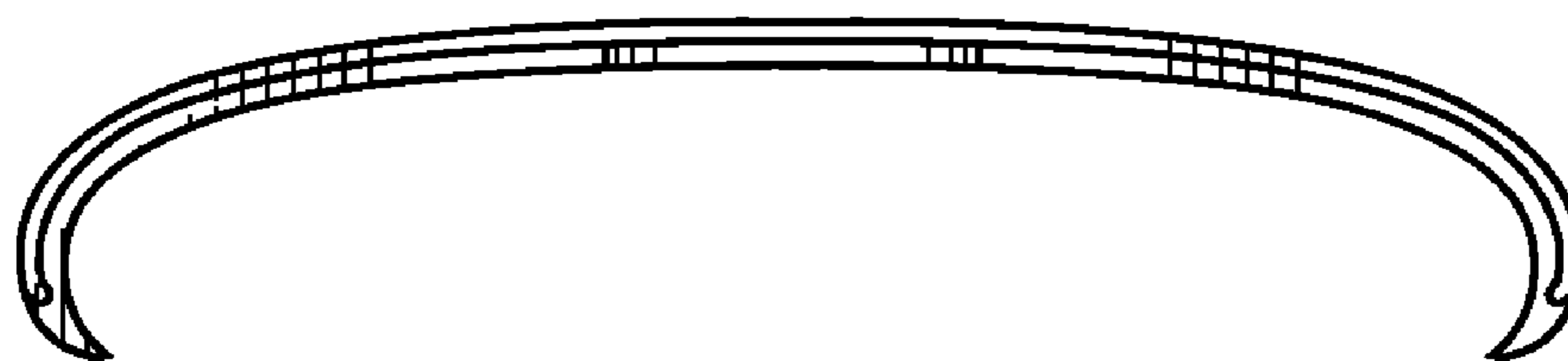

FIG. 6



FIG. 7

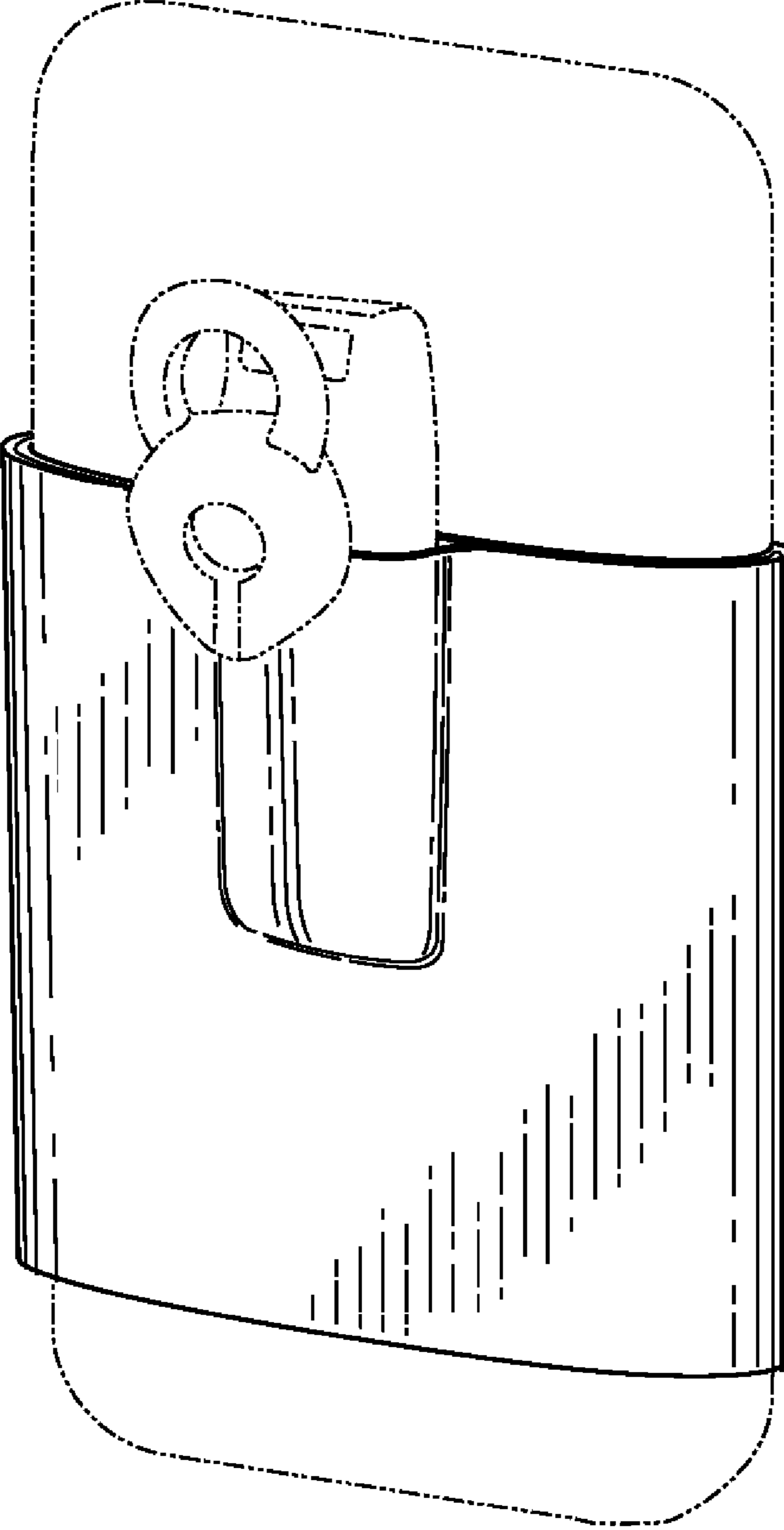

FIG. 8