



US00D609809S

(12) **United States Design Patent**
Summerer et al.

(10) **Patent No.:** **US D609,809 S**

(45) **Date of Patent:** **** Feb. 9, 2010**

(54) **HANDLE FOR MEDICAL INSTRUMENT**

(75) Inventors: **Sabine Summerer**, Tuttlingen (DE);
Uwe Bacher, Tuttlingen (DE)

(73) Assignee: **Karl Storz GmbH & Co. KG** (DE)

(**) Term: **14 Years**

(21) Appl. No.: **29/328,925**

(22) Filed: **Dec. 4, 2008**

(30) **Foreign Application Priority Data**

Jun. 4, 2008 (EM) 000946199

(51) **LOC (9) Cl.** **24-02**

(52) **U.S. Cl.** **D24/138**

(58) **Field of Classification Search** D24/108,
D24/112-114, 133, 138, 143, 146, 147; 606/167,
606/174, 205, 564

See application file for complete search history.

(56) **References Cited**

U.S. PATENT DOCUMENTS

D263,635 S * 3/1982 Wendt D24/114
D319,697 S * 9/1991 Prindle et al. D24/113
D466,209 S * 11/2002 Bon D24/112
D495,413 S * 8/2004 Perry et al. D24/108
D533,939 S * 12/2006 Root et al. D24/138

D568,993 S * 5/2008 Melanson et al. D24/133
D583,051 S * 12/2008 Lee et al. D24/133
2008/0015631 A1 * 1/2008 Lee et al. 606/205

* cited by examiner

Primary Examiner—Charles A Rademaker

Assistant Examiner—Charles D Hanson

(74) *Attorney, Agent, or Firm*—St. Onge Steward Johnston &
Reens LLC

(57) **CLAIM**

The ornamental design for a handle for medical instrument, as shown and described.

DESCRIPTION

FIG. 1 is a rear isometric view of a handle for medical instrument with a portion of the shaft missing in accordance with the new design;

FIG. 2 is a left side view thereof;

FIG. 3 is a right side view thereof;

FIG. 4 is a bottom view thereof;

FIG. 5 is a top view thereof;

FIG. 6 is a front view thereof;

FIG. 7 is a rear view thereof; and,

FIG. 8 is a rear isometric view similar to FIG. 1, but showing less detail.

1 Claim, 8 Drawing Sheets

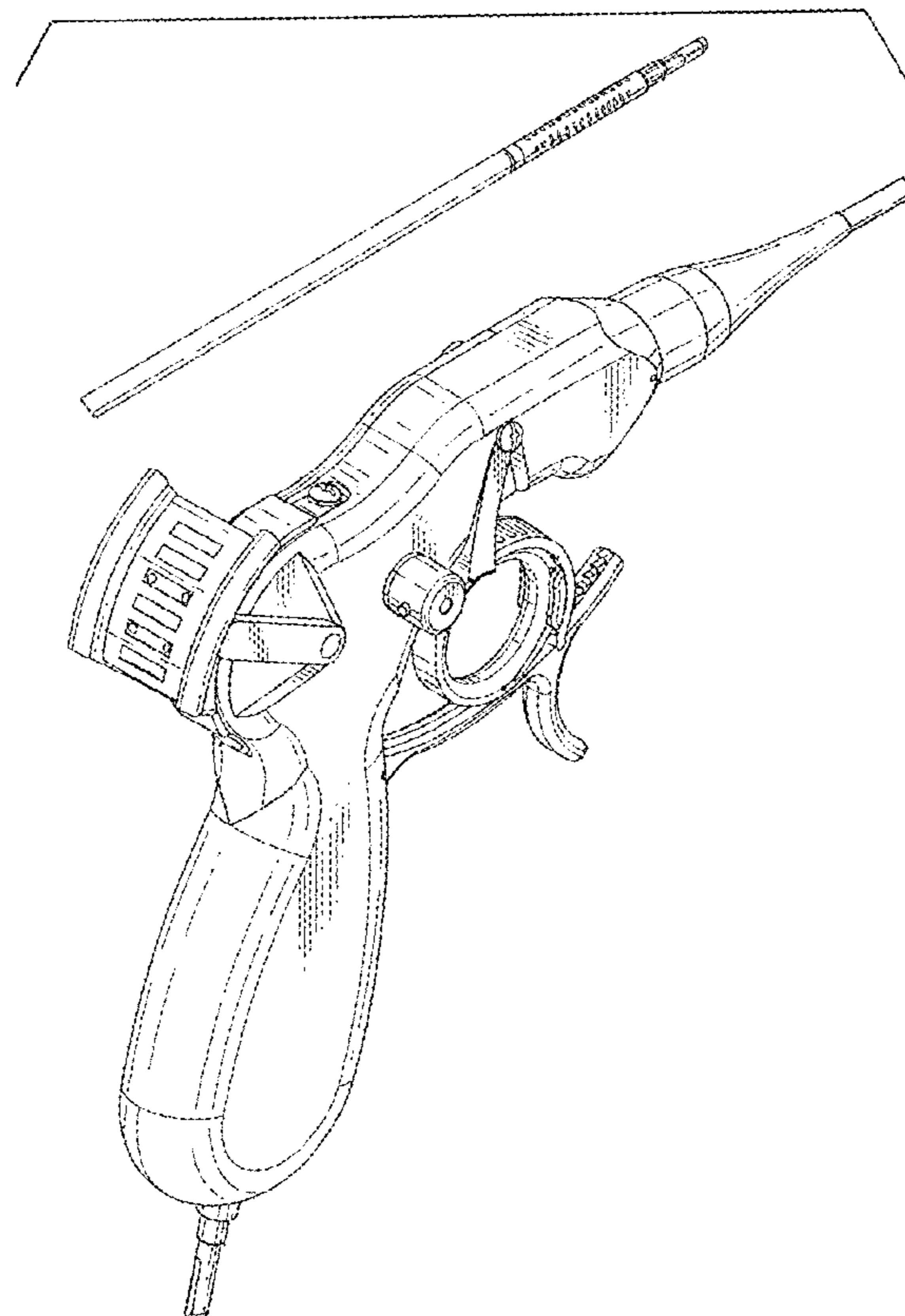

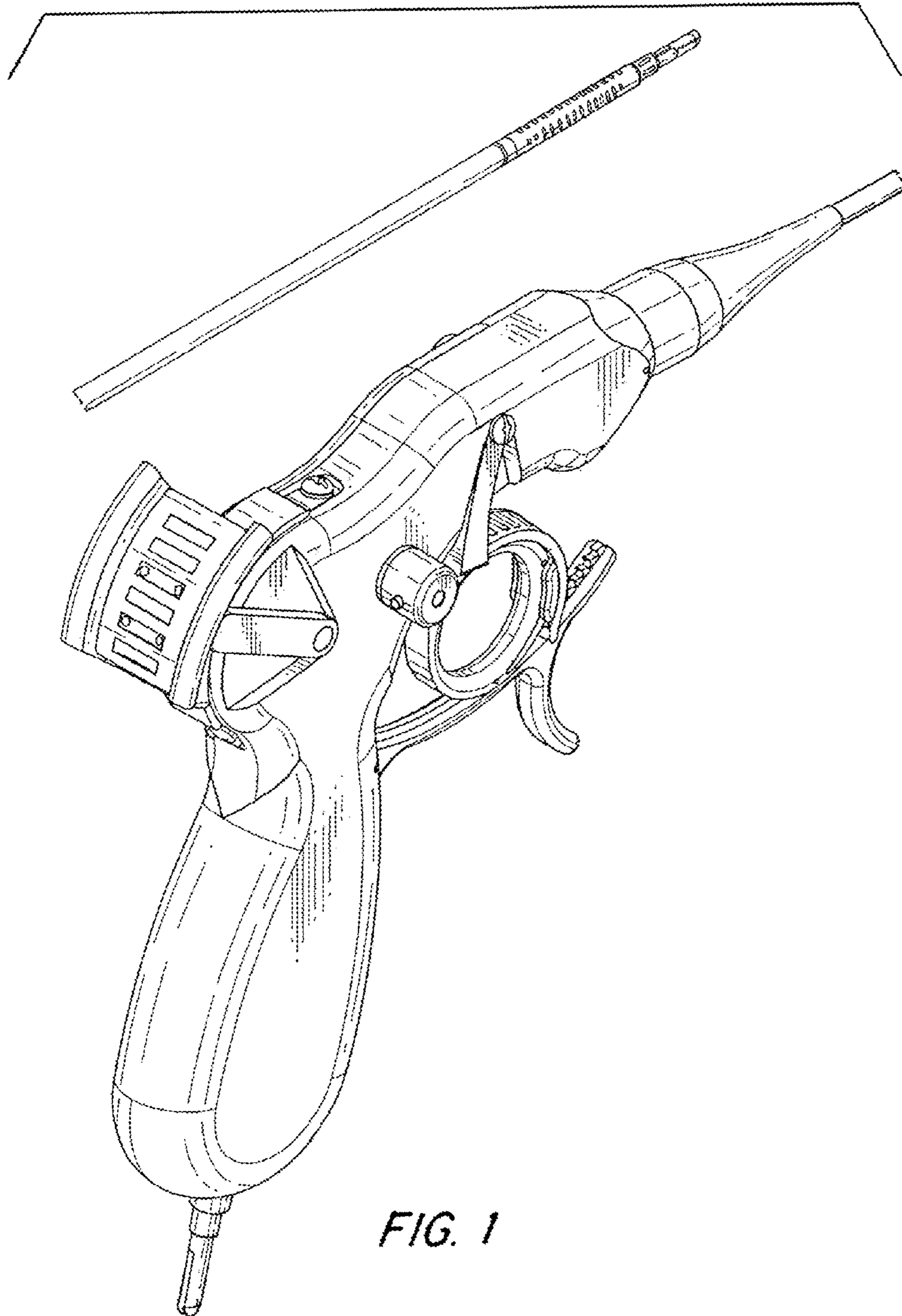

FIG. 1

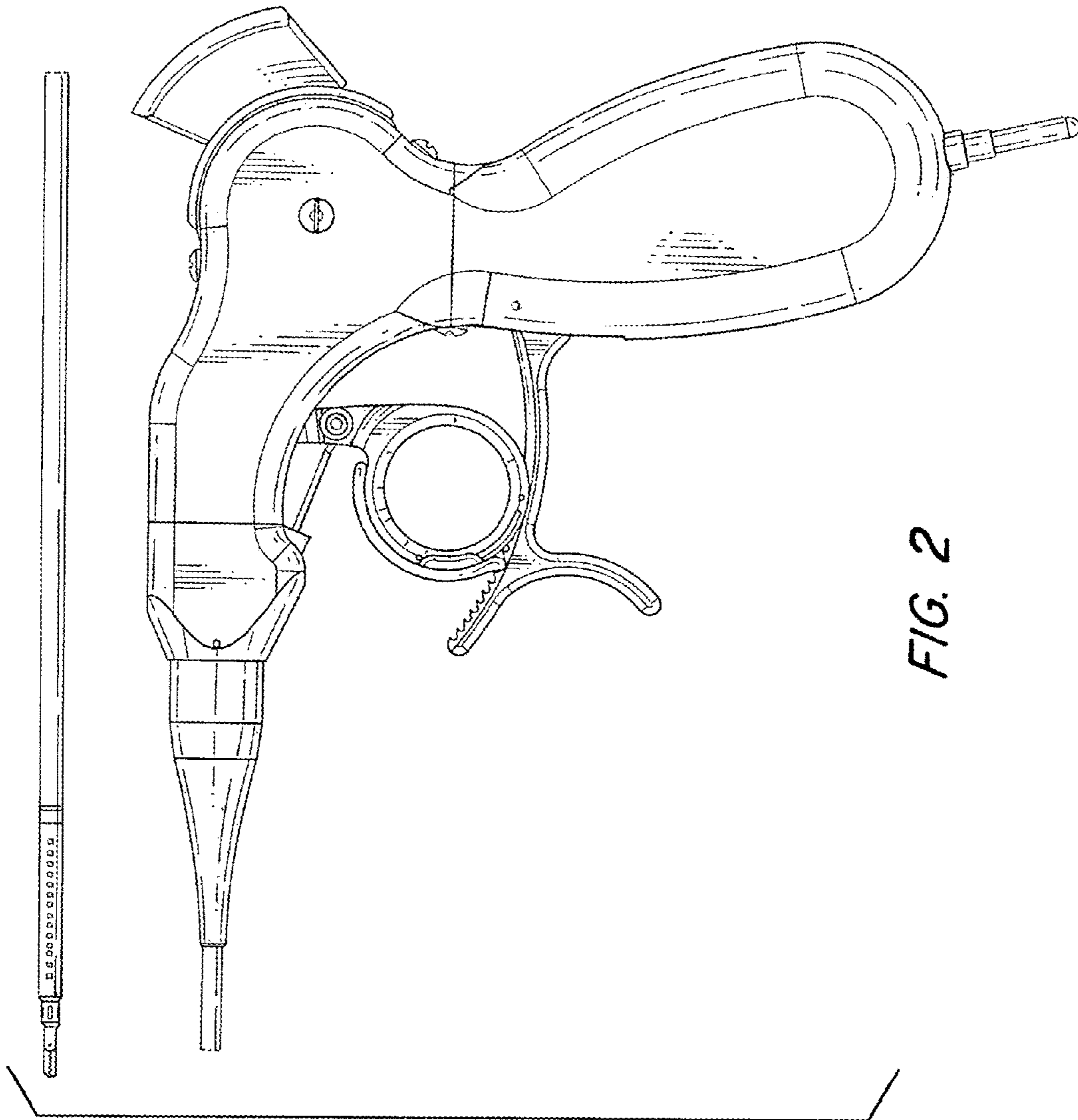

FIG. 2

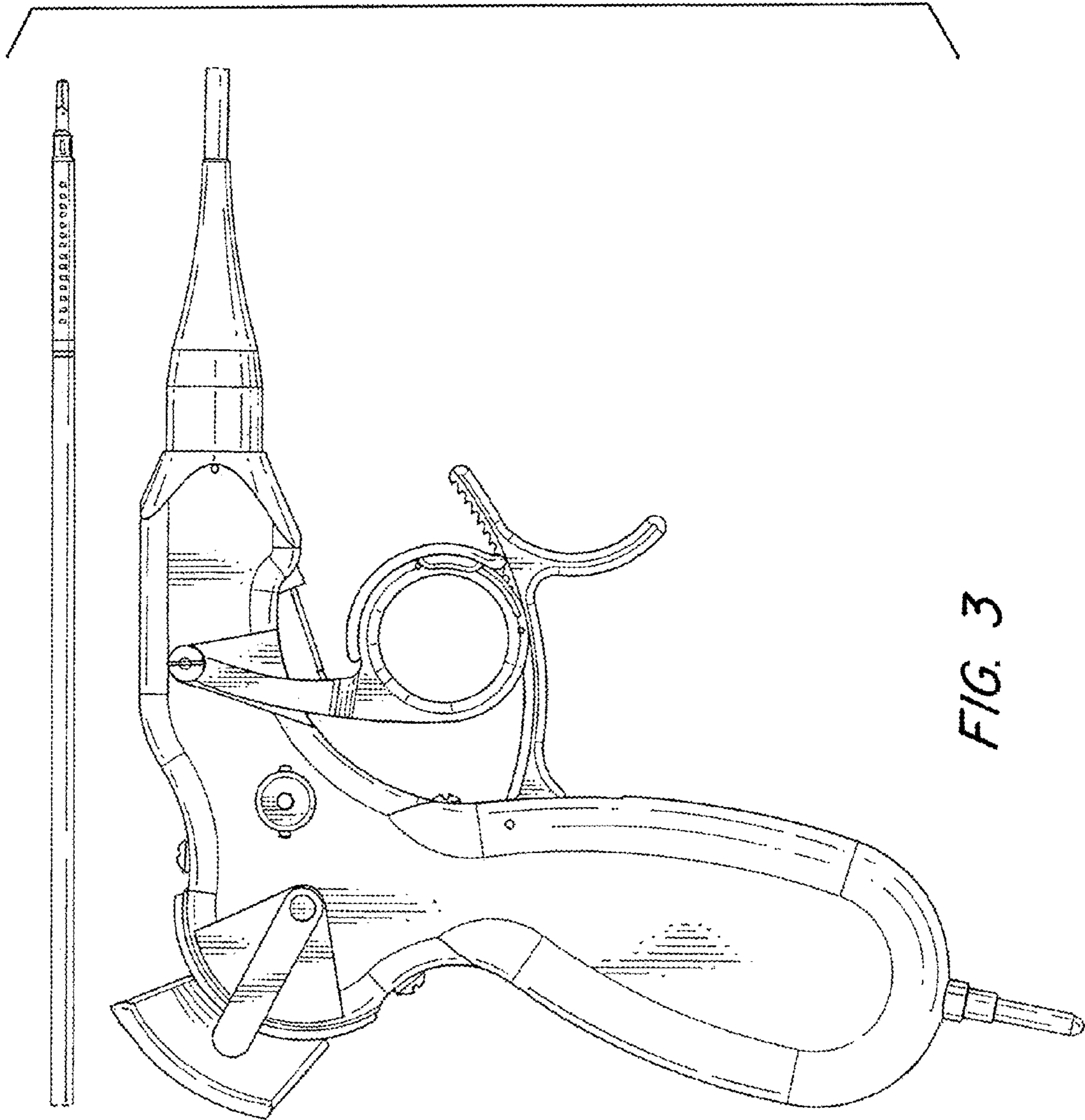

FIG. 3

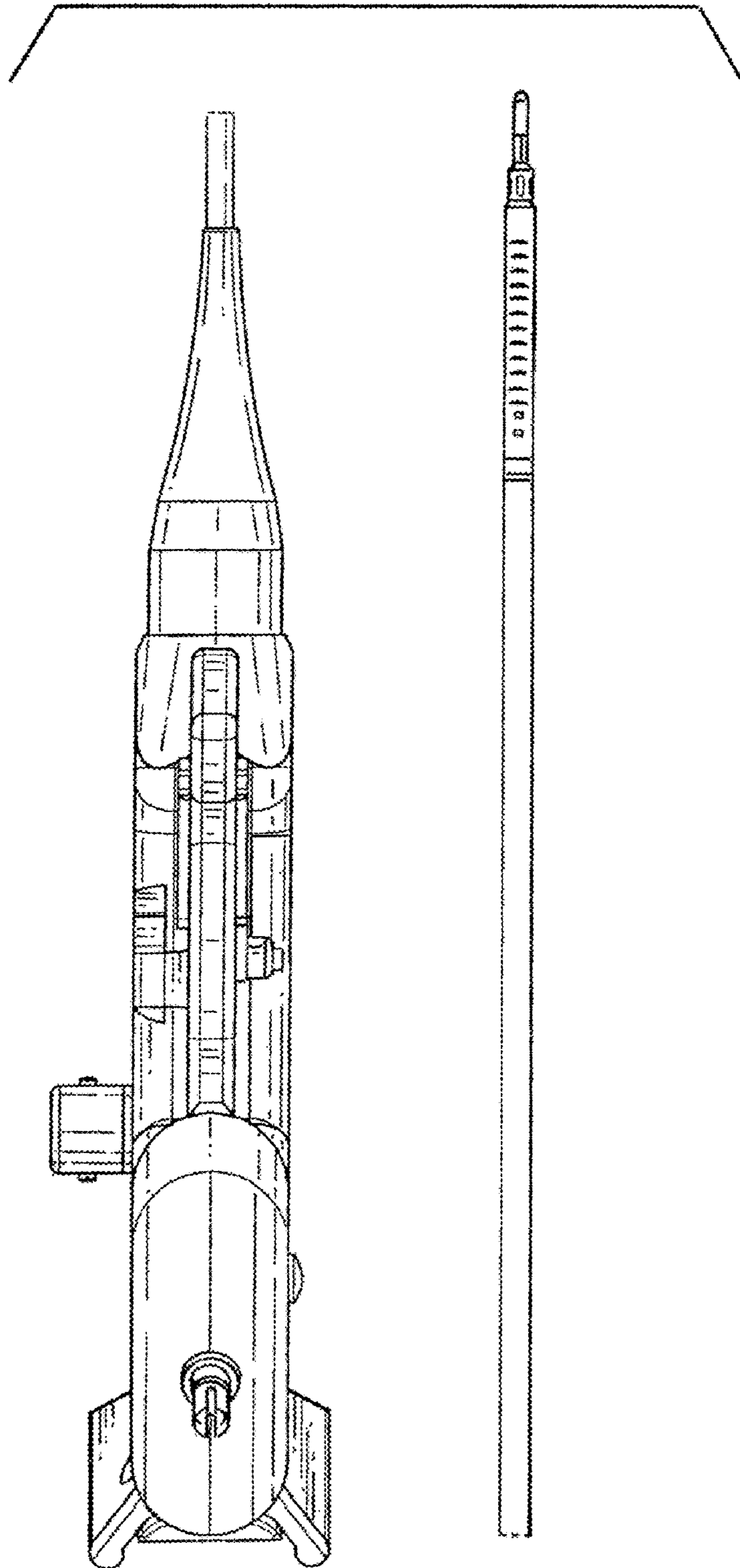

FIG. 4

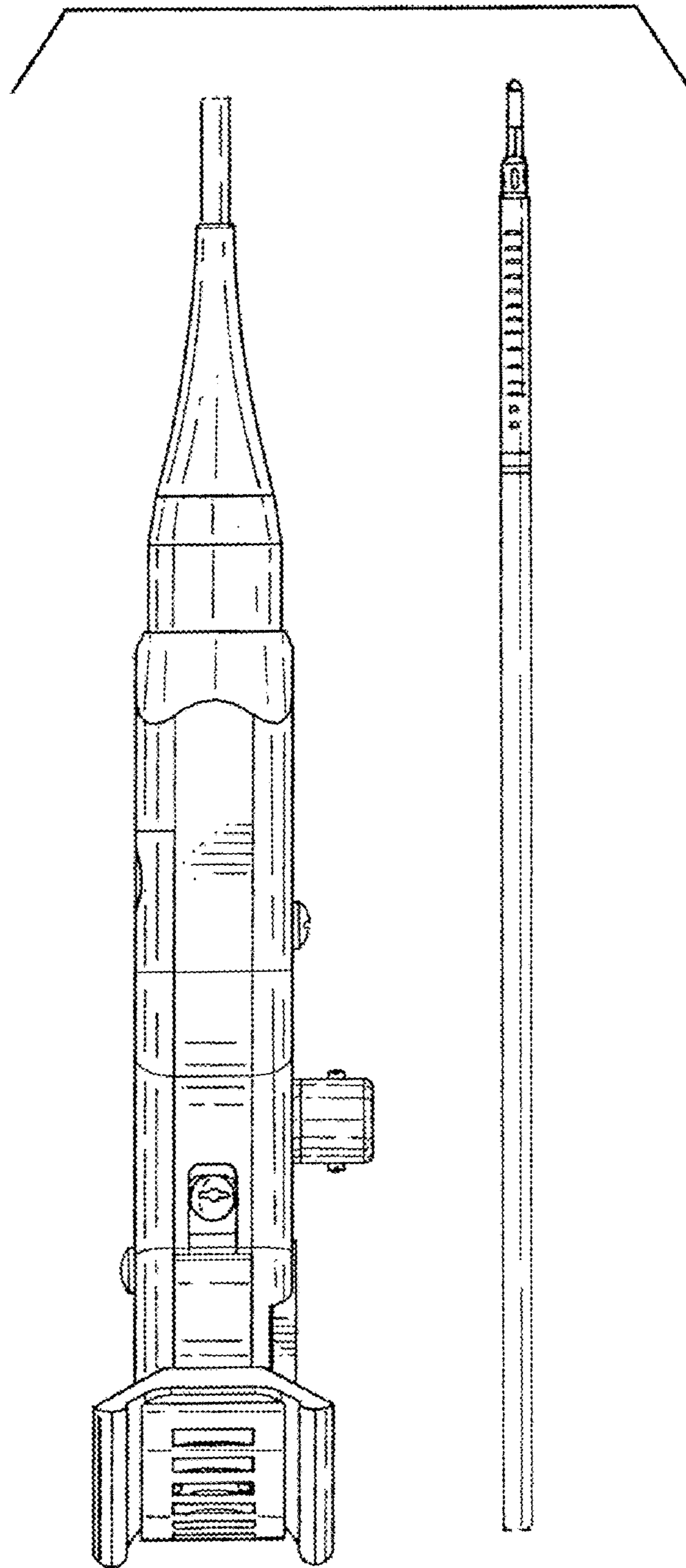

FIG. 5

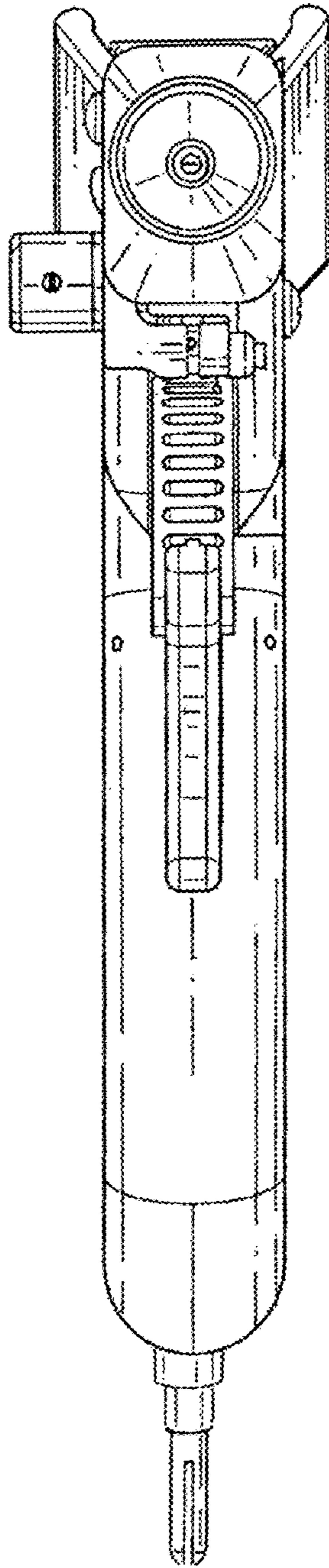

FIG. 6

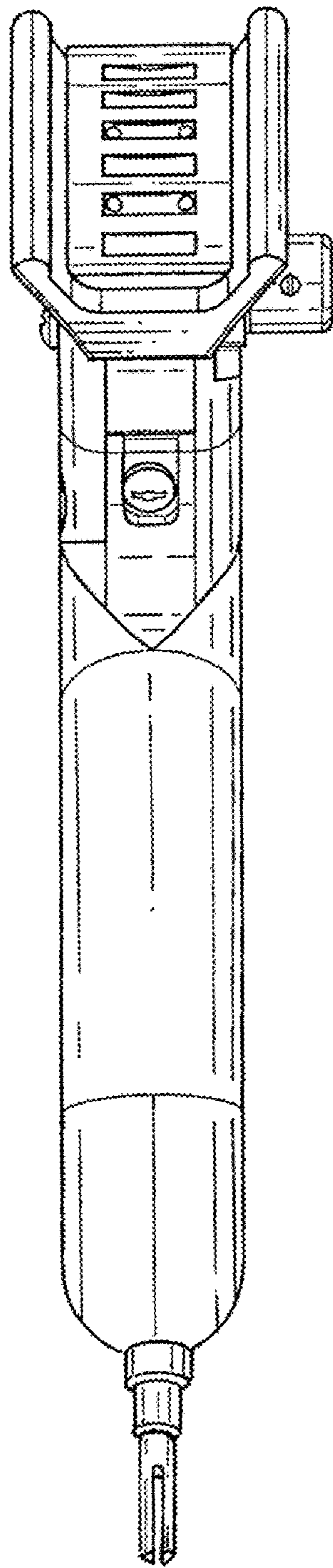

FIG. 7

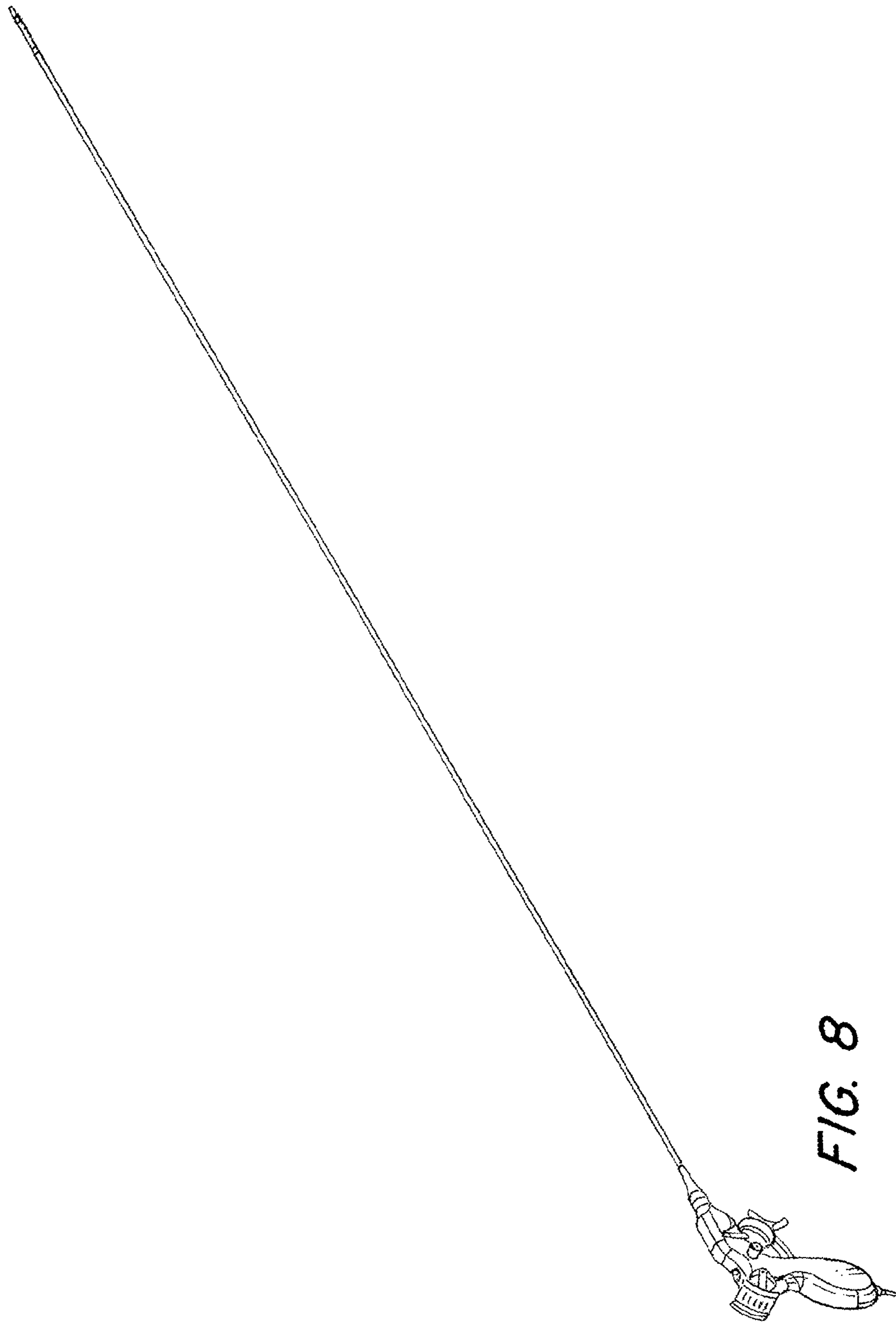

FIG. 8