



US00D609684S

(12) **United States Design Patent**
Nara et al.

(10) **Patent No.:** **US D609,684 S**
(45) **Date of Patent:** **** Feb. 9, 2010**

(54) **MOBILE TELEPHONE**

(75) Inventors: **Katsuhiro Nara**, Tokyo (JP); **Masaru Jinde**, Kanagawa (JP)

(73) Assignee: **Casio Hitachi Mobile Communications, Co., Ltd.**, Tokyo (JP)

(**) Term: **14 Years**

(21) Appl. No.: **29/334,896**

(22) Filed: **Apr. 3, 2009**

(51) **LOC (9) Cl.** **14-03**

(52) **U.S. Cl.** **D14/138 AB**

(58) **Field of Classification Search** D14/138 AB,
D14/138 R, 138 AD, 345, 346, 147, 203.4,
D14/203.7, 203.2, 144; 455/575.3; 379/433.1,
379/433.11, 433.13; D21/517

See application file for complete search history.

(56) **References Cited**

U.S. PATENT DOCUMENTS

D488,810 S *	4/2004	Lin et al.	D14/341
D489,699 S *	5/2004	Hwang et al.	D14/138 AB
D491,906 S *	6/2004	Okamatsu	D14/138 AB
D491,907 S *	6/2004	Ogawa	D14/138 AB
D506,738 S *	6/2005	Kim et al.	D14/138 AB
D507,553 S *	7/2005	Gotou et al.	D14/138 AB
D508,030 S *	8/2005	Jeoung et al.	D14/138 AB
D510,078 S *	9/2005	Lee et al.	D14/138 AB
D510,733 S *	10/2005	Lee et al.	D14/138 AB
D536,318 S *	2/2007	Kim et al.	D14/138 AB
D545,798 S *	7/2007	Kimbre	D14/138 AB
D546,310 S *	7/2007	Lee	D14/138 AB
D546,794 S *	7/2007	Kim et al.	D14/138 AB
D558,708 S *	1/2008	Wolf et al.	D14/138 AB
D558,709 S *	1/2008	Nilsen et al.	D14/138 AB
D563,928 S *	3/2008	Sugioka	D14/138 AB
D565,004 S *	3/2008	Oh et al.	D14/138 AB
D565,531 S *	4/2008	Park et al.	D14/138 AB
D566,078 S *	4/2008	Nara	D14/138 AB
D566,670 S *	4/2008	Huang	D14/138 AB
D570,813 S *	6/2008	Song et al.	D14/138 AB
D576,995 S *	9/2008	Jinde et al.	D14/138 AB
D589,481 S *	3/2009	Nara et al.	D14/138 AB
D592,167 S *	5/2009	Park et al.	D14/138 AD

D592,630 S * 5/2009 Robertson et al. D14/138 AB
2009/0233658 A1* 9/2009 Murayama et al. 455/575.3

OTHER PUBLICATIONS

LG M4300 telephone, announced 1st quarter 2005, [online], [site visited Nov. 6, 2009]. Available from Internet ,<URL: http://www.gsmarena.com>.*

NEC N500i telephone, announced Feb. 2006, [online], [site visited Nov. 6, 2009]. Available from Internet ,<URL: http://www.gsmarena.com>.*

Sony Ericsson Z300 telephone, announced Nov. 2005, [online], [site visited Nov. 6, 2009]. Available from Internet ,<URL: http://www.gsmarena.com>.*

* cited by examiner

Primary Examiner—Jeffrey D Asch

(74) *Attorney, Agent, or Firm*—Frishauf, Holtz, Goodman & Chick, P.C.

(57) **CLAIM**

The ornamental design for a mobile telephone, as shown and described.

DESCRIPTION

FIG. 1 is a front, right side and bottom perspective view of a mobile telephone showing our new design;

FIG. 2 is a front elevational view thereof;

FIG. 3 is a rear elevational view thereof;

FIG. 4 is a left side view thereof;

FIG. 5 is a right side view thereof;

FIG. 6 is a top plan view thereof;

FIG. 7 is a bottom plan view thereof;

FIG. 8 is a perspective view thereof, with the front member in an open position, and drawn to a smaller scale;

FIG. 9 is a front elevational view thereof;

FIG. 10 is a rear elevational view thereof;

FIG. 11 is a left side view thereof;

FIG. 12 is a right side view thereof;

FIG. 13 is a top plan view thereof; and,

FIG. 14 is a bottom plan view thereof.

1 Claim, 14 Drawing Sheets

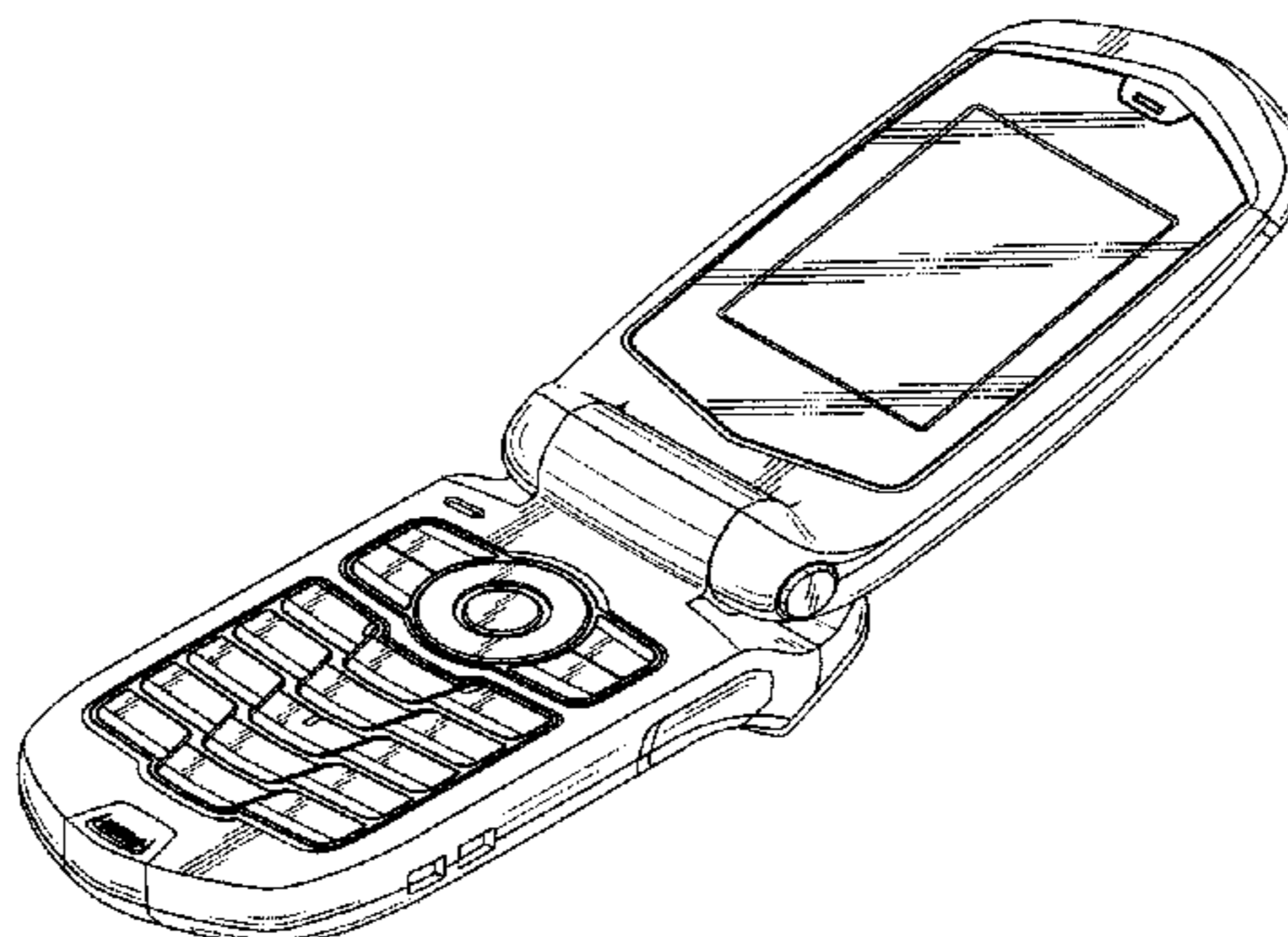
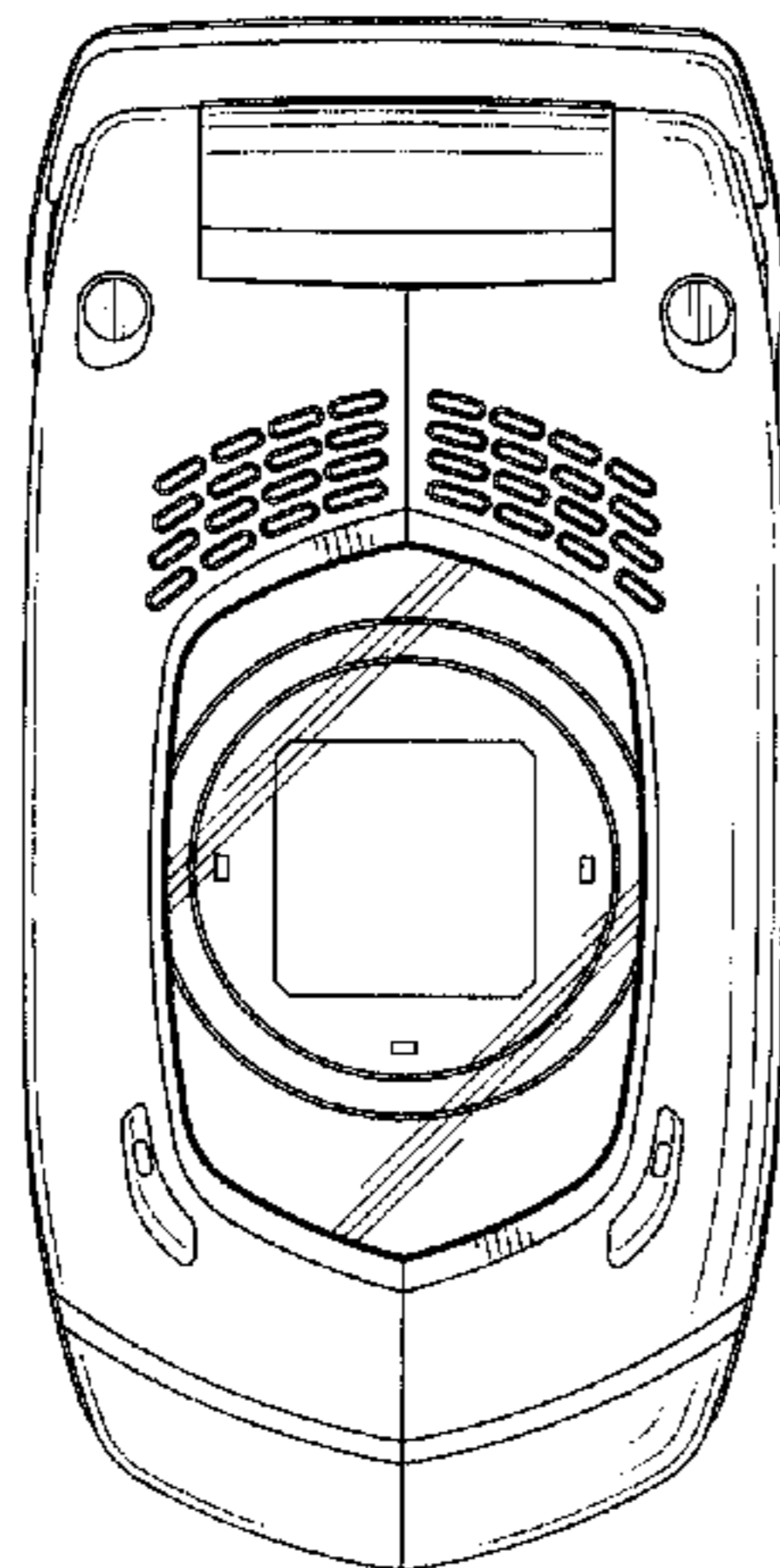

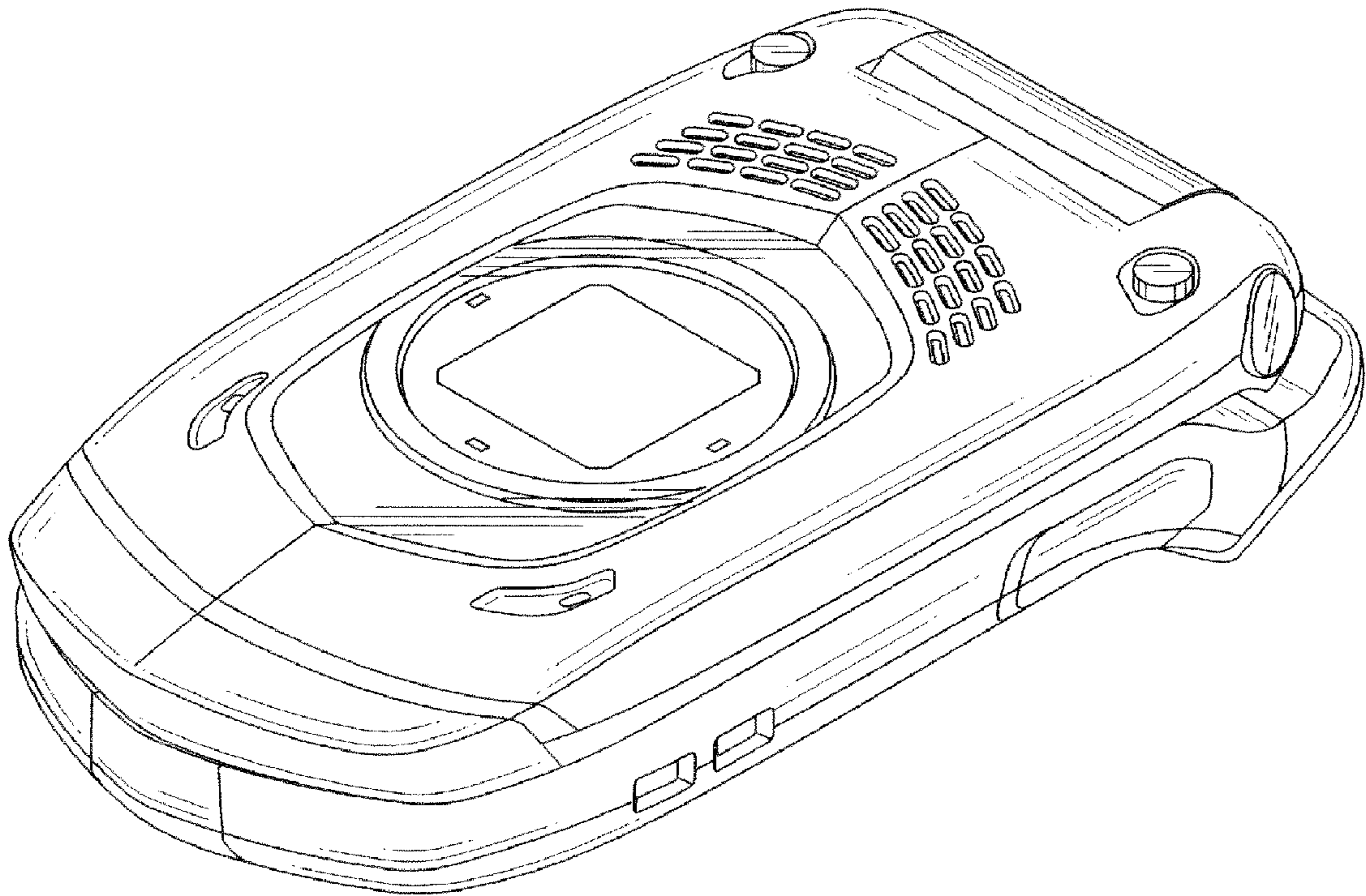

FIG. 1

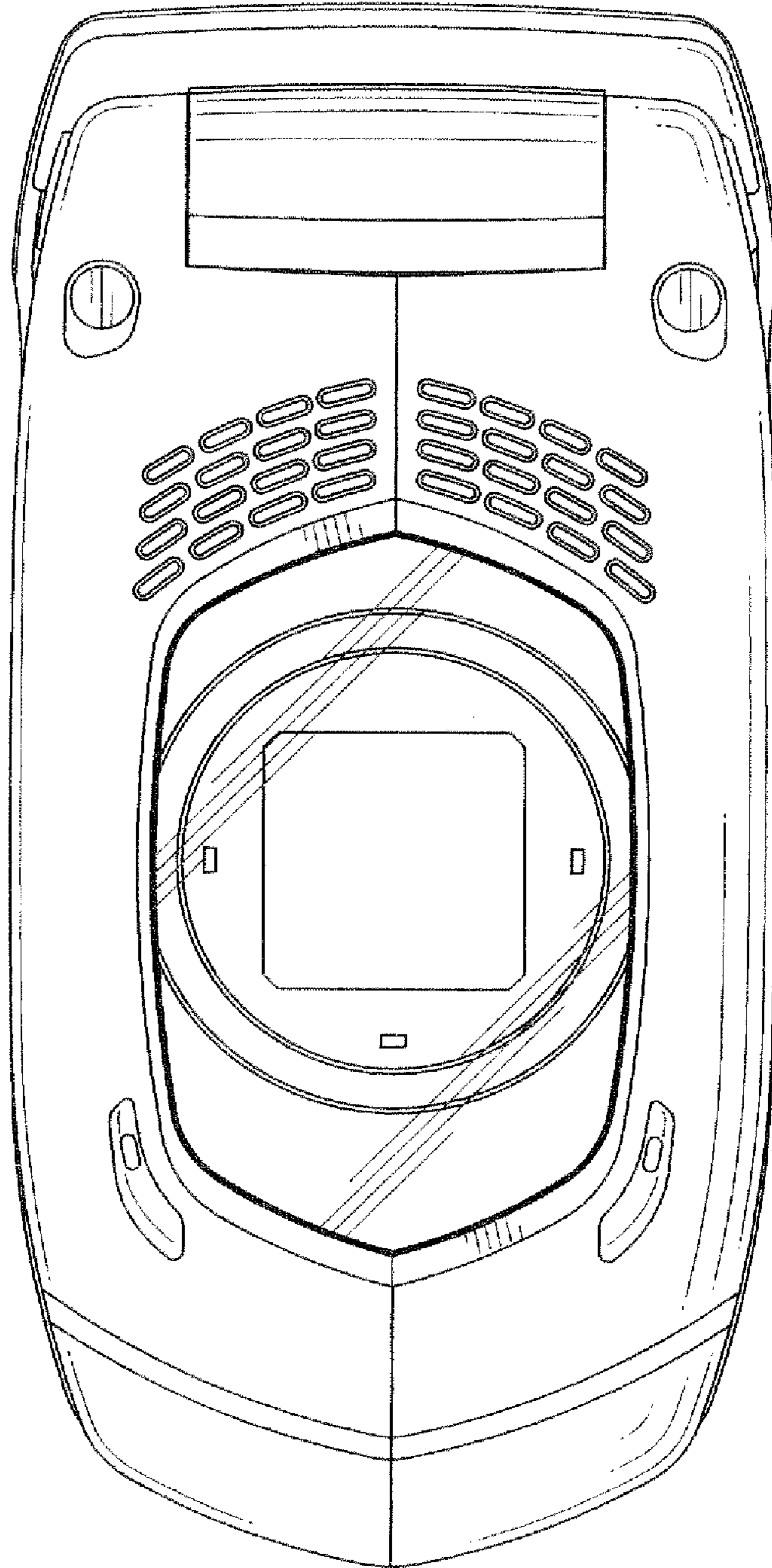

FIG. 2

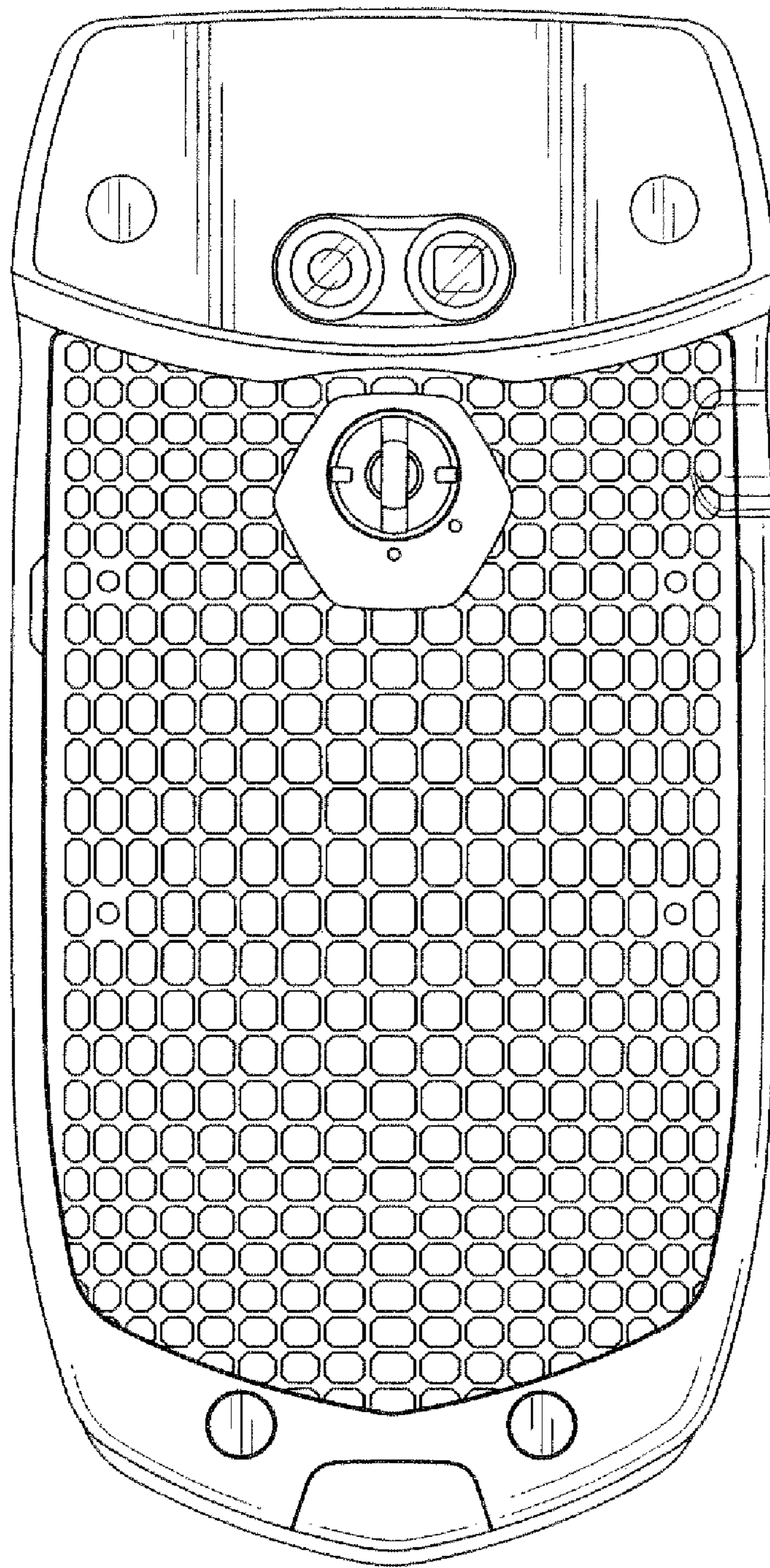

FIG. 3

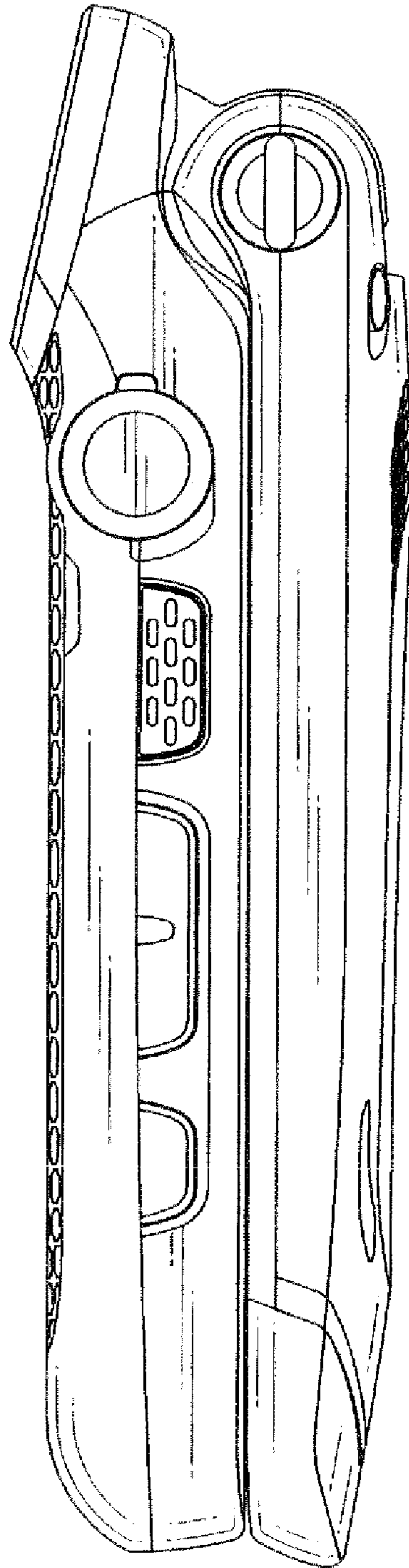

FIG. 4

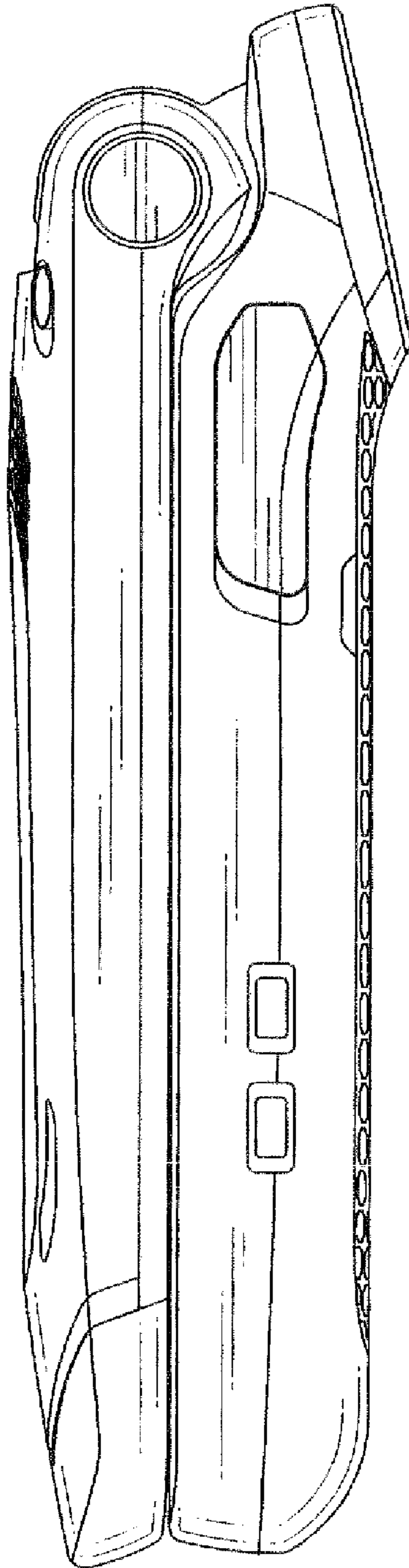

FIG. 5

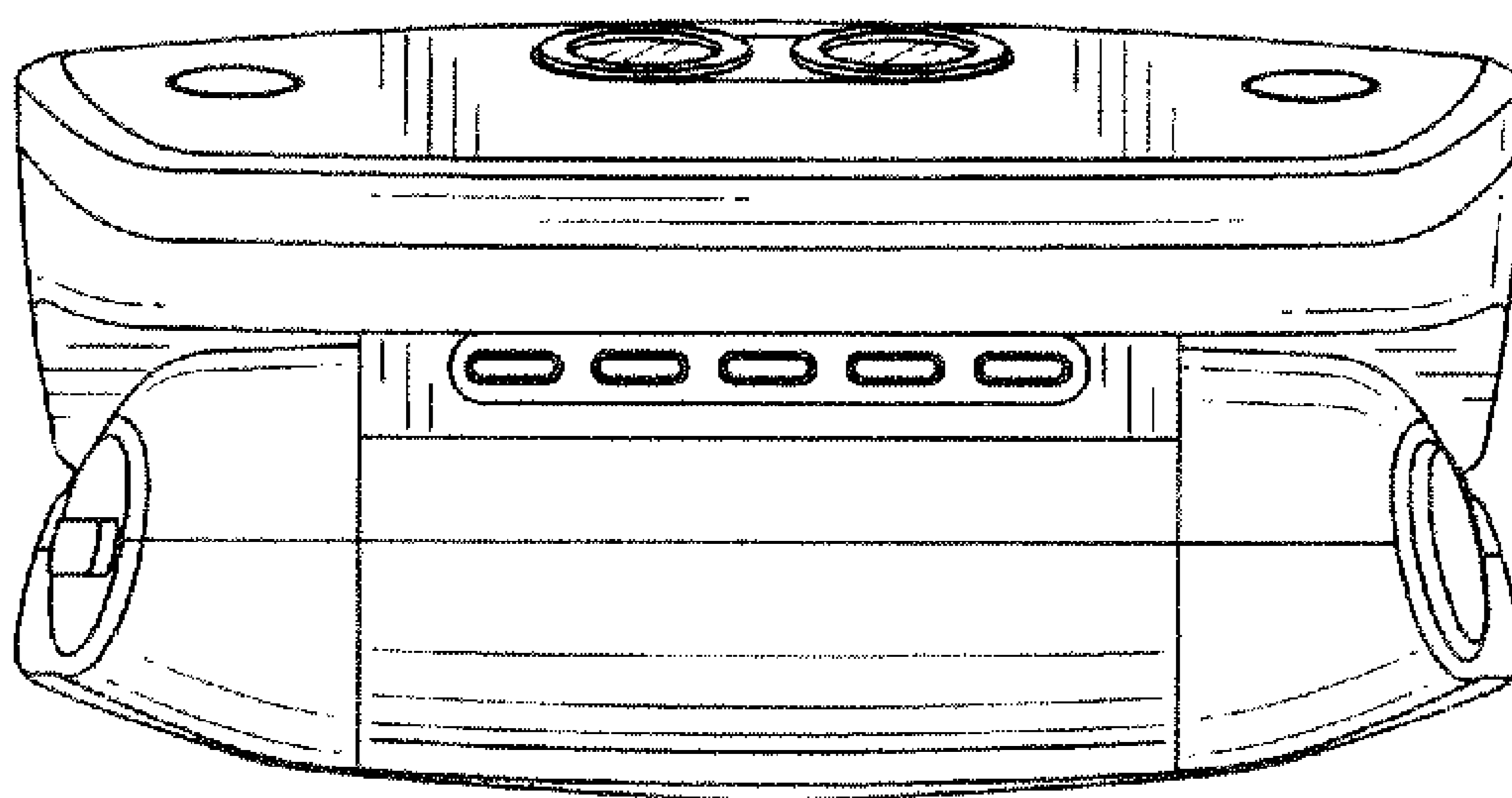

FIG 6

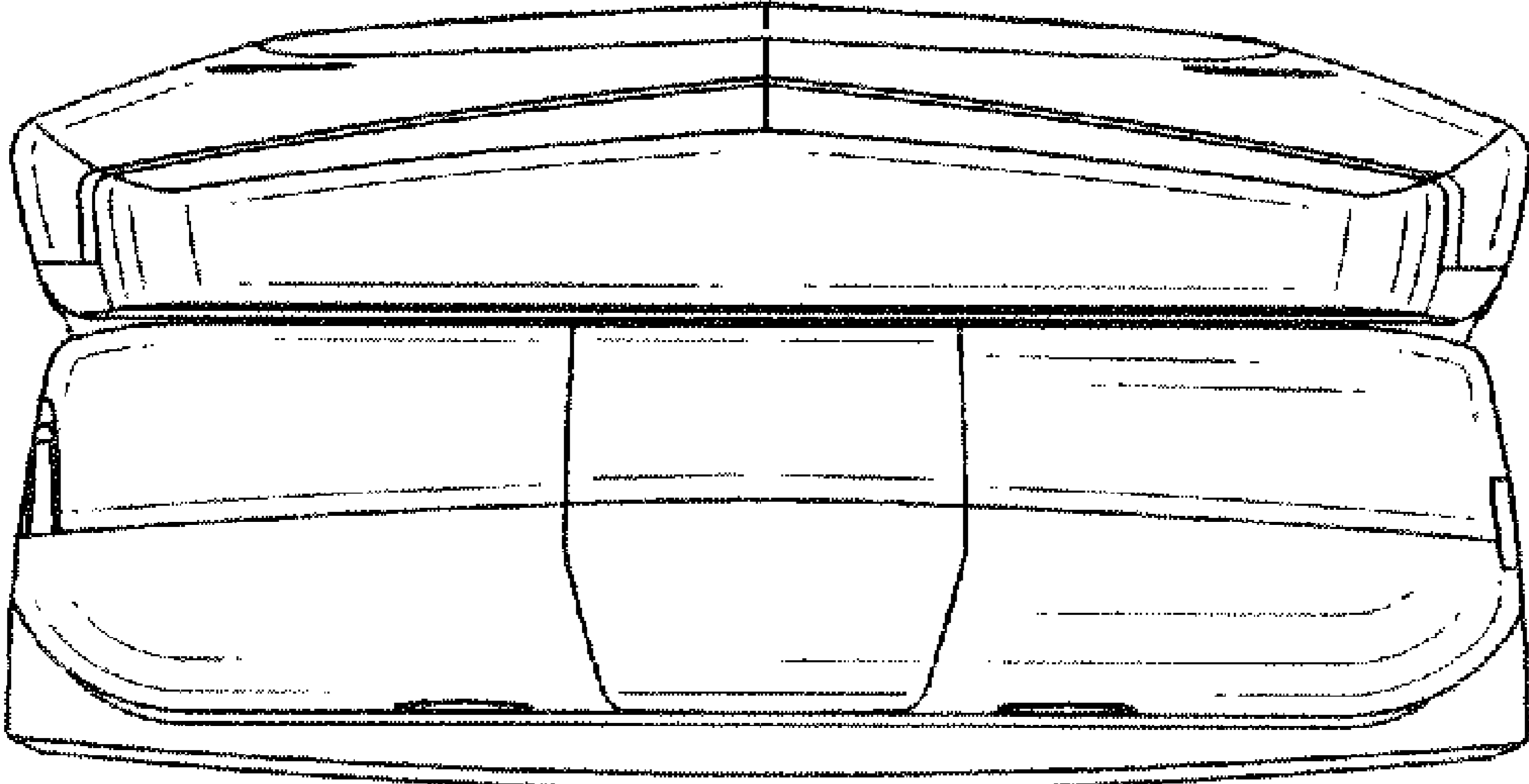

FIG 7

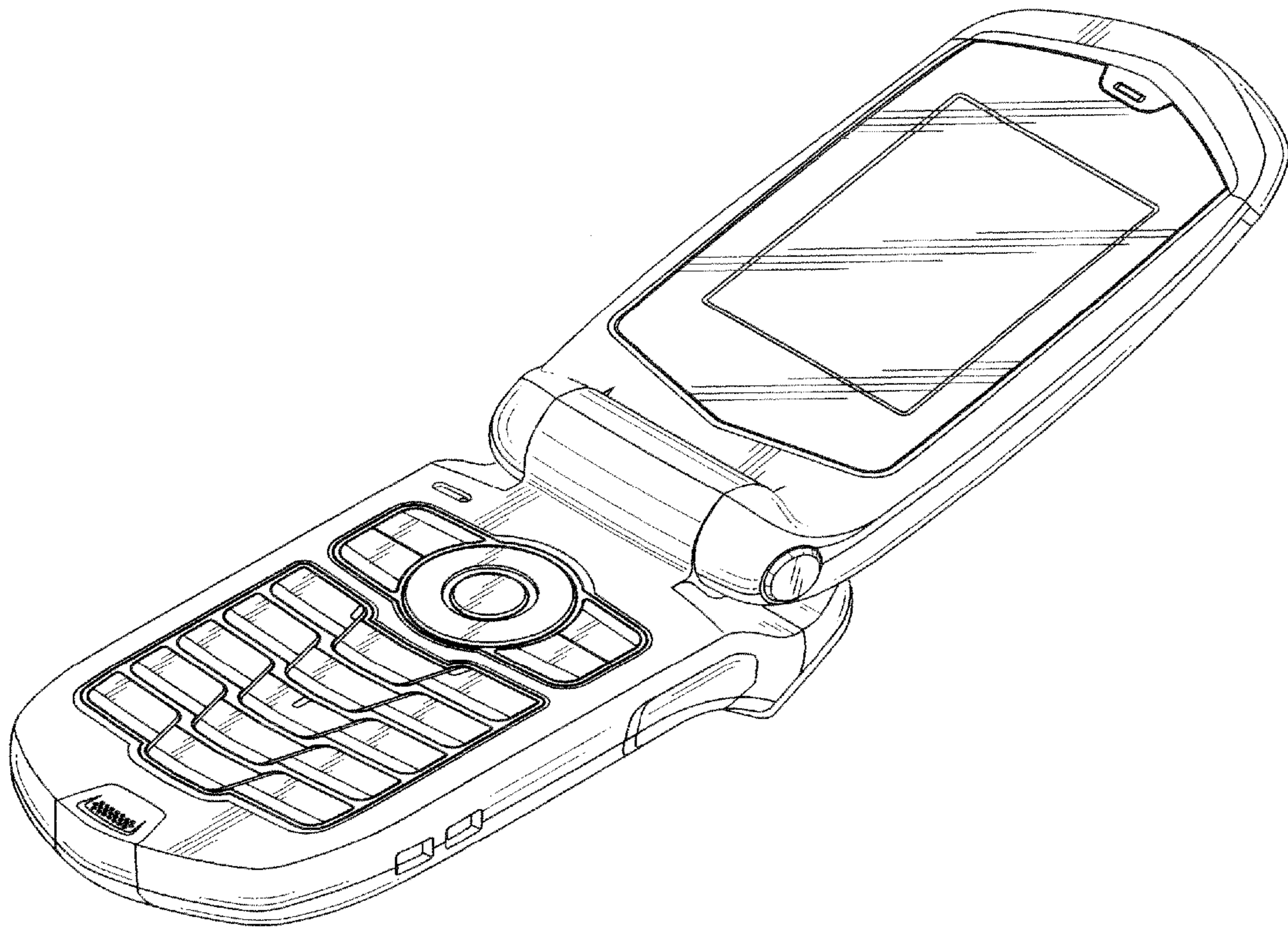

FIG. 8

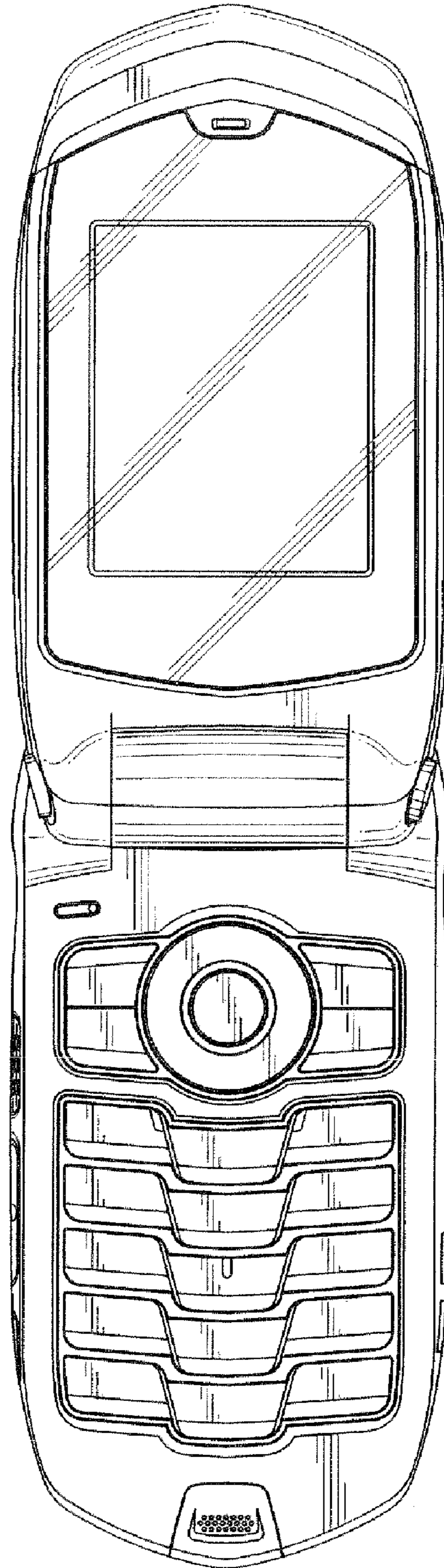

FIG. 9

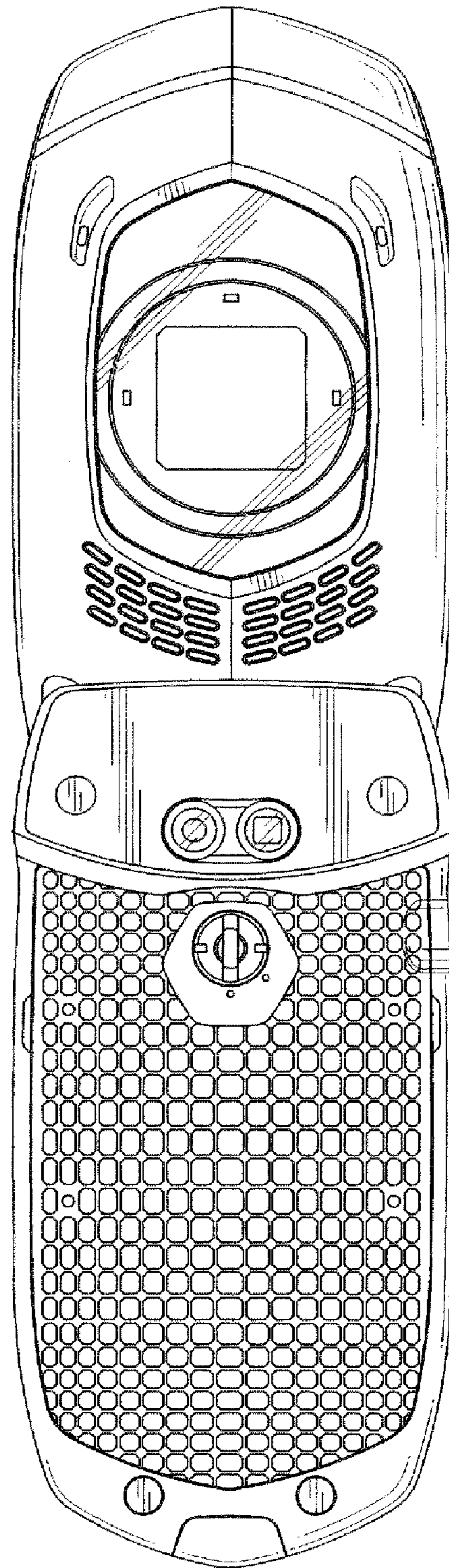

FIG. 10

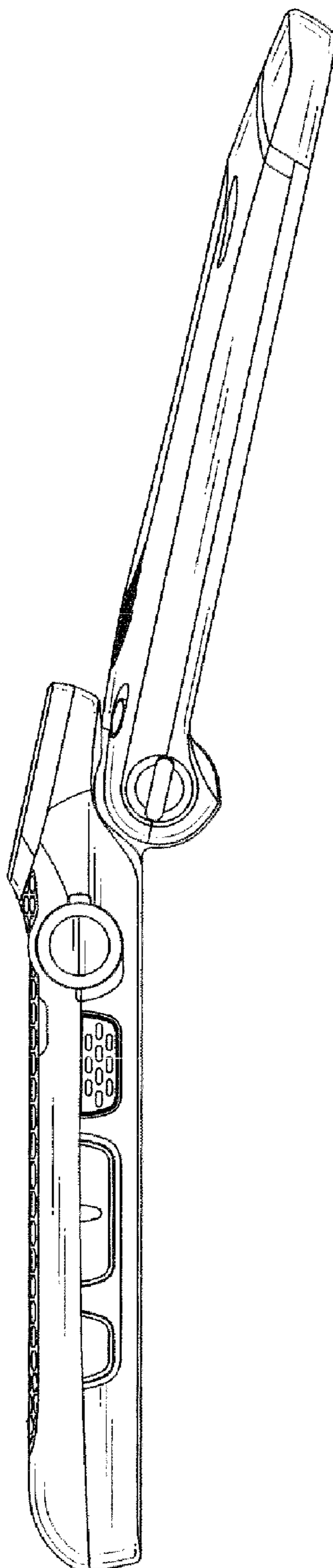

FIG. 11

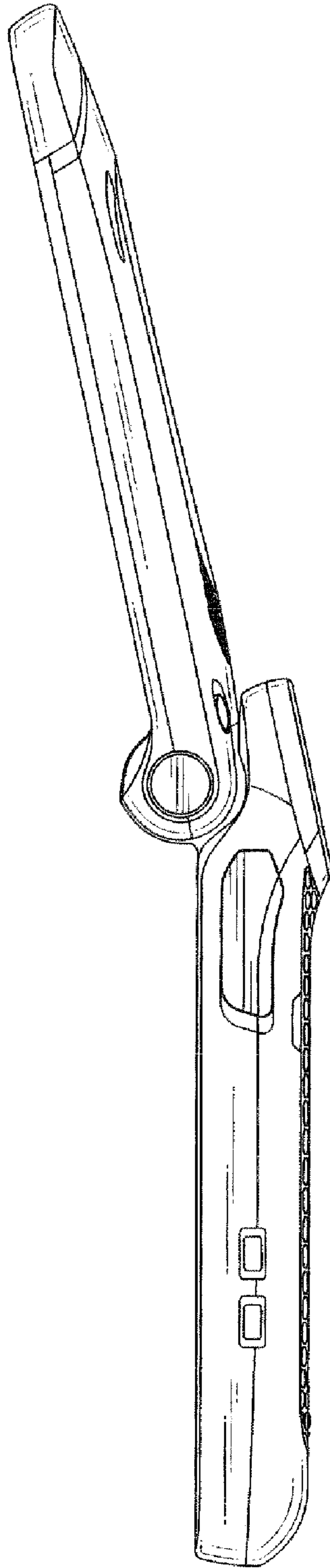

FIG. 12

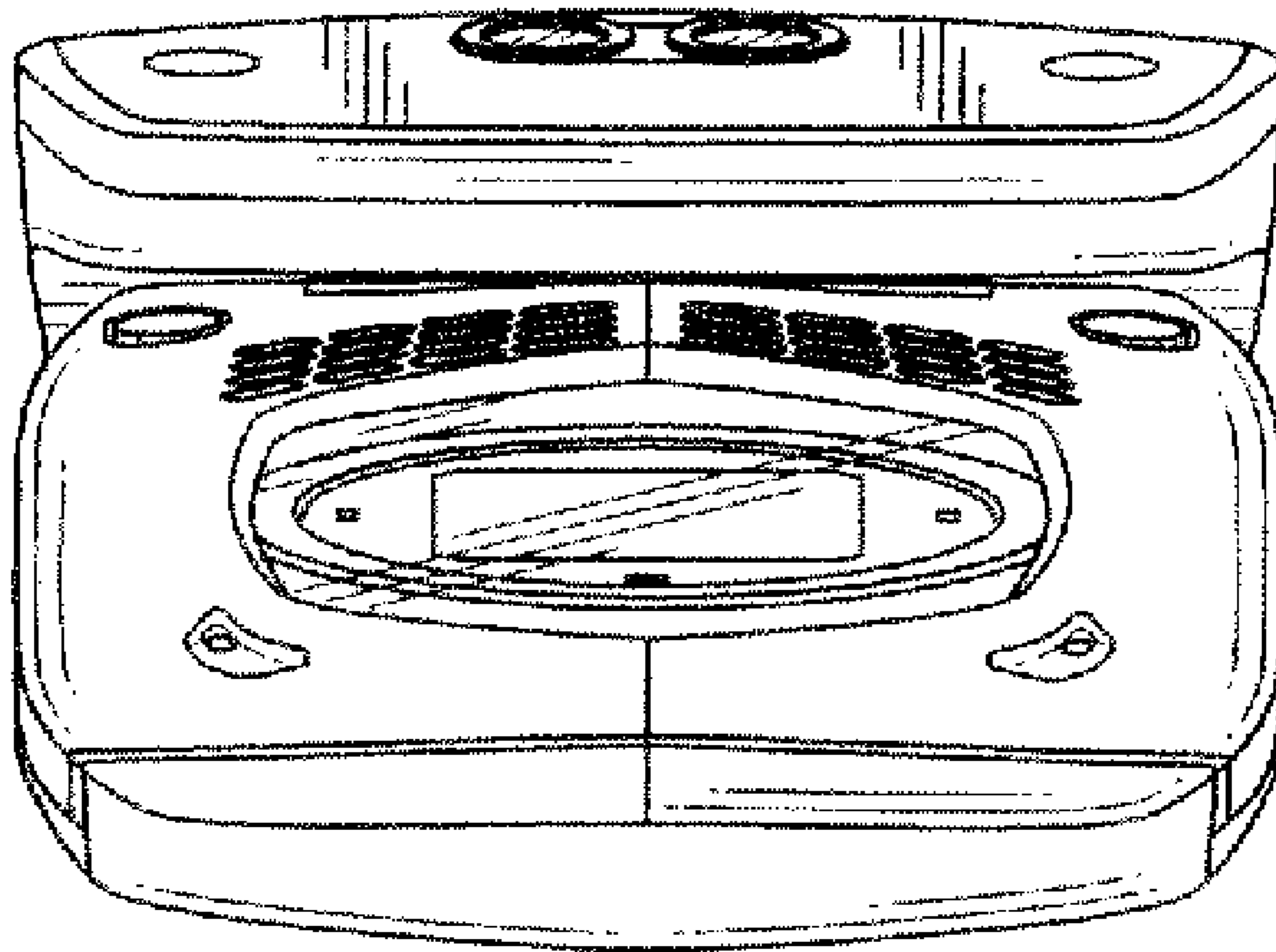

FIG 13

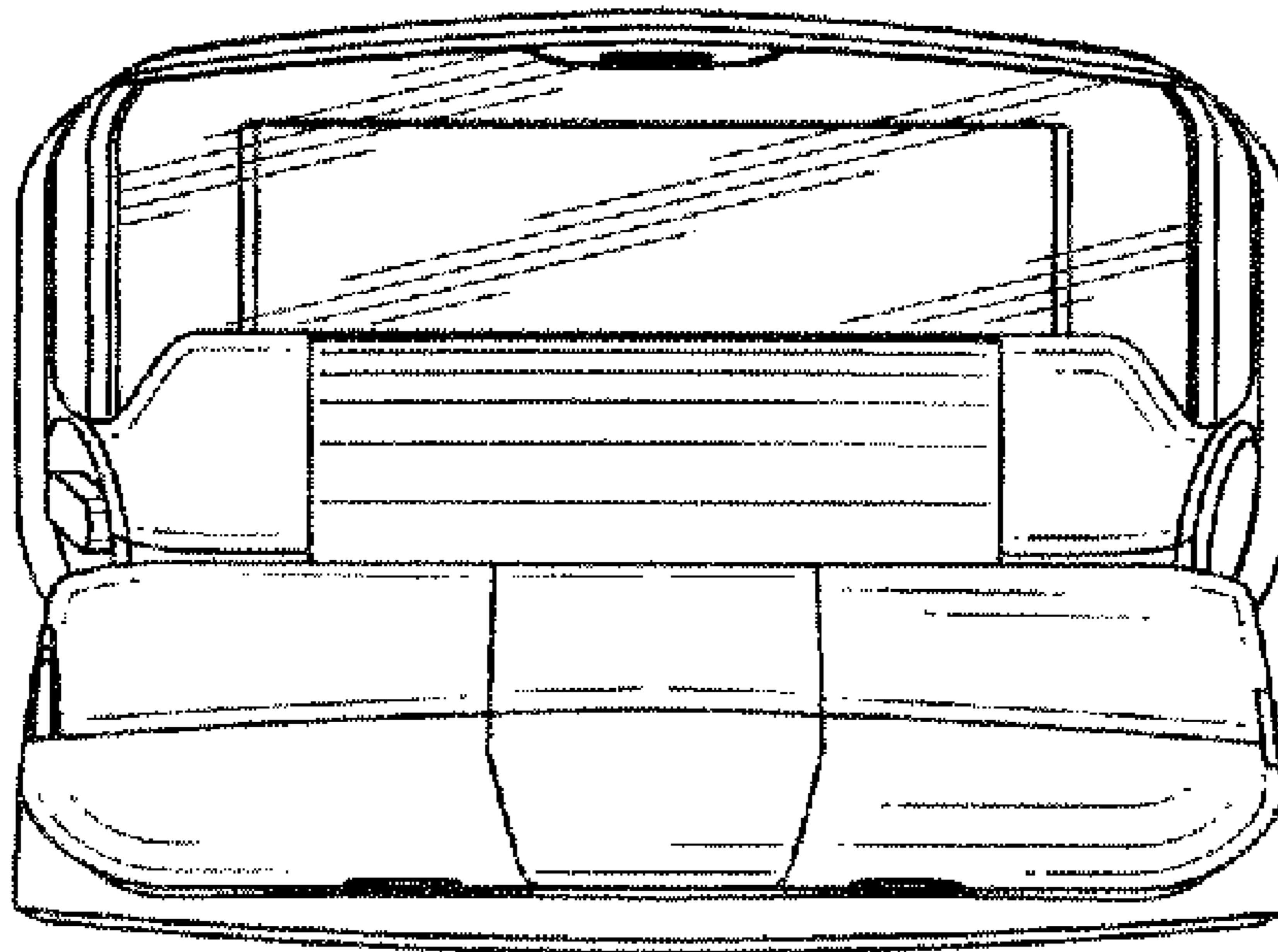

FIG. 14