

US00D609660S

(12) **United States Design Patent**  
**VanDuyn et al.**

(10) **Patent No.:** **US D609,660 S**  
(45) **Date of Patent:** **\*\* Feb. 9, 2010**

(54) **TV AND BASE**

D598,406 S \* 8/2009 Wang ..... D14/126

(75) Inventors: **Luke VanDuyn**, Highlands Ranch, CO (US); **Daniel L Rudolph**, Castle Rock, CO (US); **Neil Marten**, Denver, CO (US); **Dallas Grove**, San Carlos, CA (US)

(73) Assignees: **EchoStar Technologies L.L.C.**, Edglewood, CO (US); **Sling Media, Inc.**, Foster City, CA (US)

(\*\*) Term: **14 Years**

(21) Appl. No.: **29/336,717**

(22) Filed: **May 7, 2009**

(51) **LOC (9) Cl.** ..... **14-03**

(52) **U.S. Cl.** ..... **D14/126**

(58) **Field of Classification Search** ..... D14/125-134, D14/239, 371, 136, 374-377, 440, 450, 448, D14/336, 342; 312/7.2; 348/836, 838, 180, 348/184, 325, 739; 341/12; 248/917-924, 248/465; 345/104, 133, 156, 168, 87, 173; 720/605, 669, 600, 655; 369/99, 197; 455/344, 455/347; D21/329, 515, 577, 622, 333, 433, D21/448, 452, 450, 331; D6/477, 479, 300; 273/148 B; 446/484, 175, 356; D10/15, D10/26

See application file for complete search history.

(56) **References Cited**

**U.S. PATENT DOCUMENTS**

D323,324 S *	1/1992	Suda	.....	D14/125
D525,953 S *	8/2006	Anzures	.....	D14/126
D548,206 S *	8/2007	Han	.....	D14/126
D550,173 S *	9/2007	Wang et al.	.....	D14/126
D581,379 S *	11/2008	Chiu	.....	D14/126
D584,281 S *	1/2009	Kim et al.	.....	D14/188
D587,226 S *	2/2009	Funayama	.....	D14/126
D596,596 S *	7/2009	Honda	.....	D14/126
D597,980 S *	8/2009	Vitito	.....	D14/129

**OTHER PUBLICATIONS**

“Portable DVD Player User Manual,” [http://www.consumerphilips.com/consumer/en/sa/consumer/cc/\\_productid\\_PET831\\_98\\_SA\\_CONSUMER/Portable-DVD-Player+PET831-98-](http://www.consumerphilips.com/consumer/en/sa/consumer/cc/_productid_PET831_98_SA_CONSUMER/Portable-DVD-Player+PET831-98-), retrieved Jul. 16, 2009, 28 pages.

“VA902b 19" Value Series LCD Display,” <http://tom.viewsonic.com/products/desktopdisplays/lcddisplays/valueseries/va902b/>, retrieved Jul. 16, 2009, 2 pages.

\* cited by examiner

*Primary Examiner*—Raphael Barkai

(74) *Attorney, Agent, or Firm*—Seed IP Law Group PLLC

(57) **CLAIM**

The ornamental design for a TV and base, as shown and described.

**DESCRIPTION**

FIG. 1 is an isometric view of a TV and base showing an embodiment of our new design.

FIG. 2 is a front elevational view thereof.

FIG. 3 is a rear elevational view thereof.

FIG. 4 is a top plan view thereof.

FIG. 5 is a bottom plan view thereof.

FIG. 6 is a right side elevational view thereof.

FIG. 7 is a left side elevational view thereof; and,

FIG. 8 is a front elevational view of a TV and base showing another embodiment of our new design: a mirror-image configuration. Apart from differences arising from the extended portion of the front TV face being relocated from the right-side, as shown in FIGS. 1 and 2, to the left-side, as shown in FIG. 8, all features in the alternate embodiment remain as shown in FIGS. 3-7.

The broken lines in the figures are for illustrative proposes only and form no part of the claimed design.

**1 Claim, 8 Drawing Sheets**

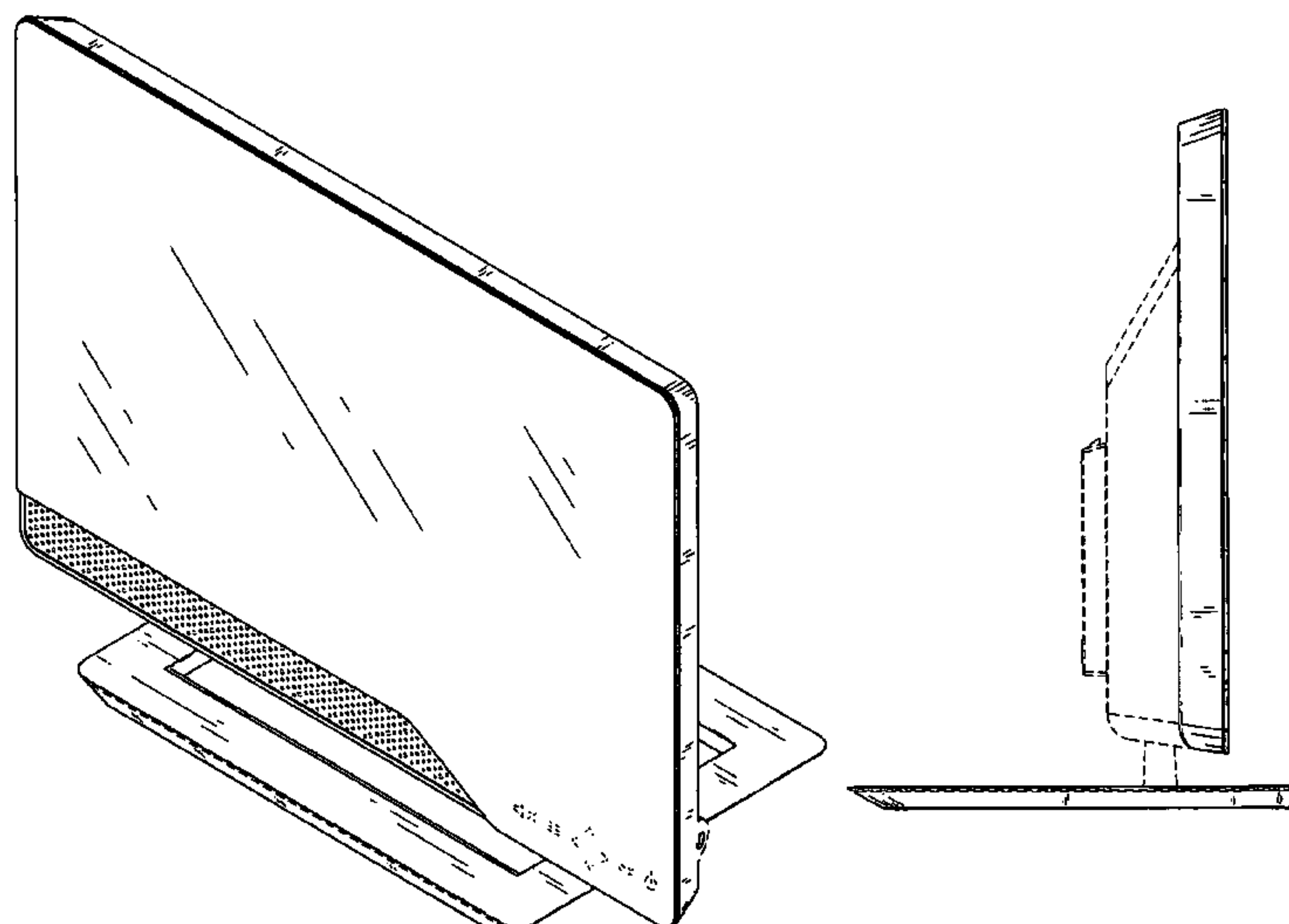

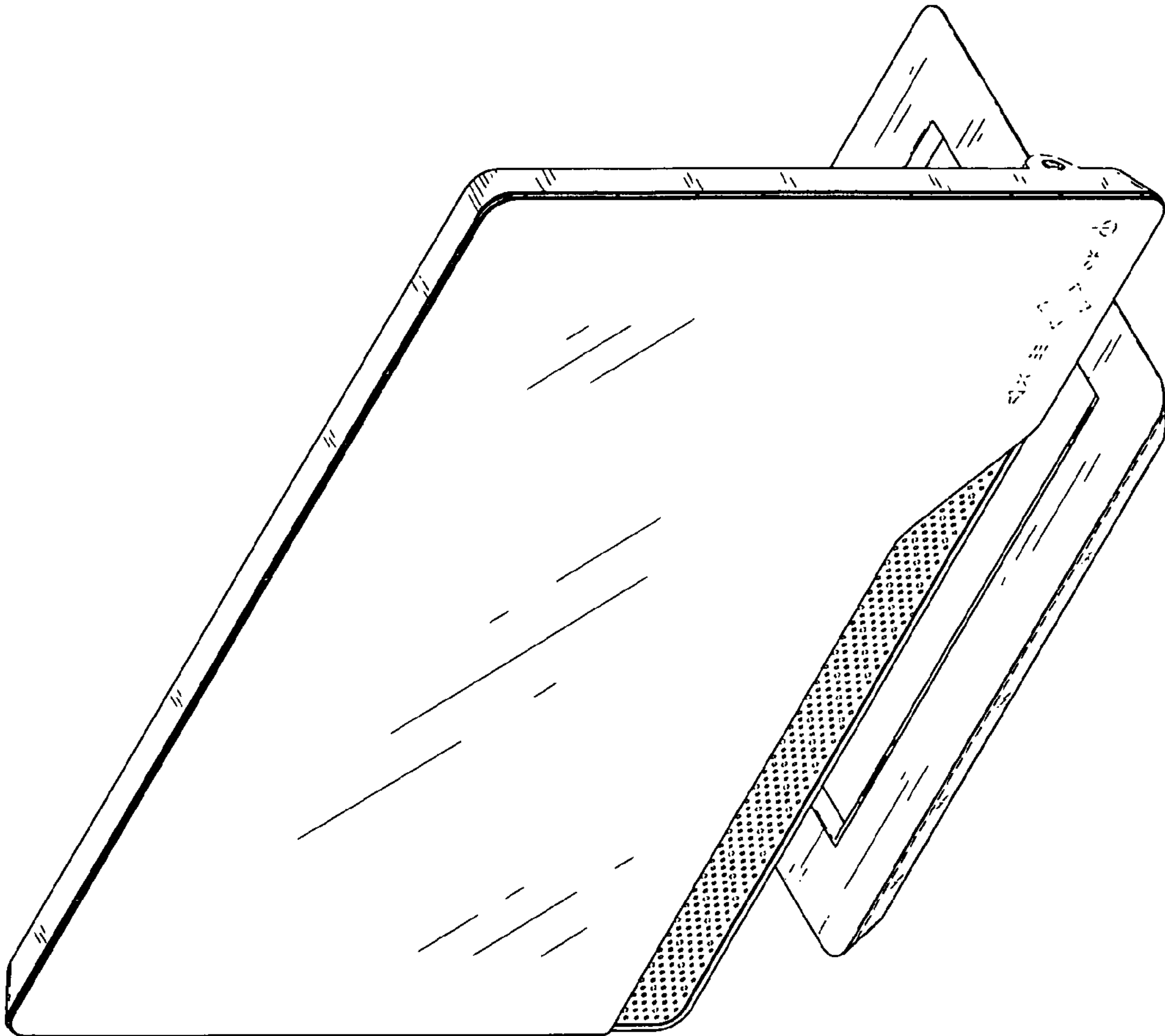

FIG. 1

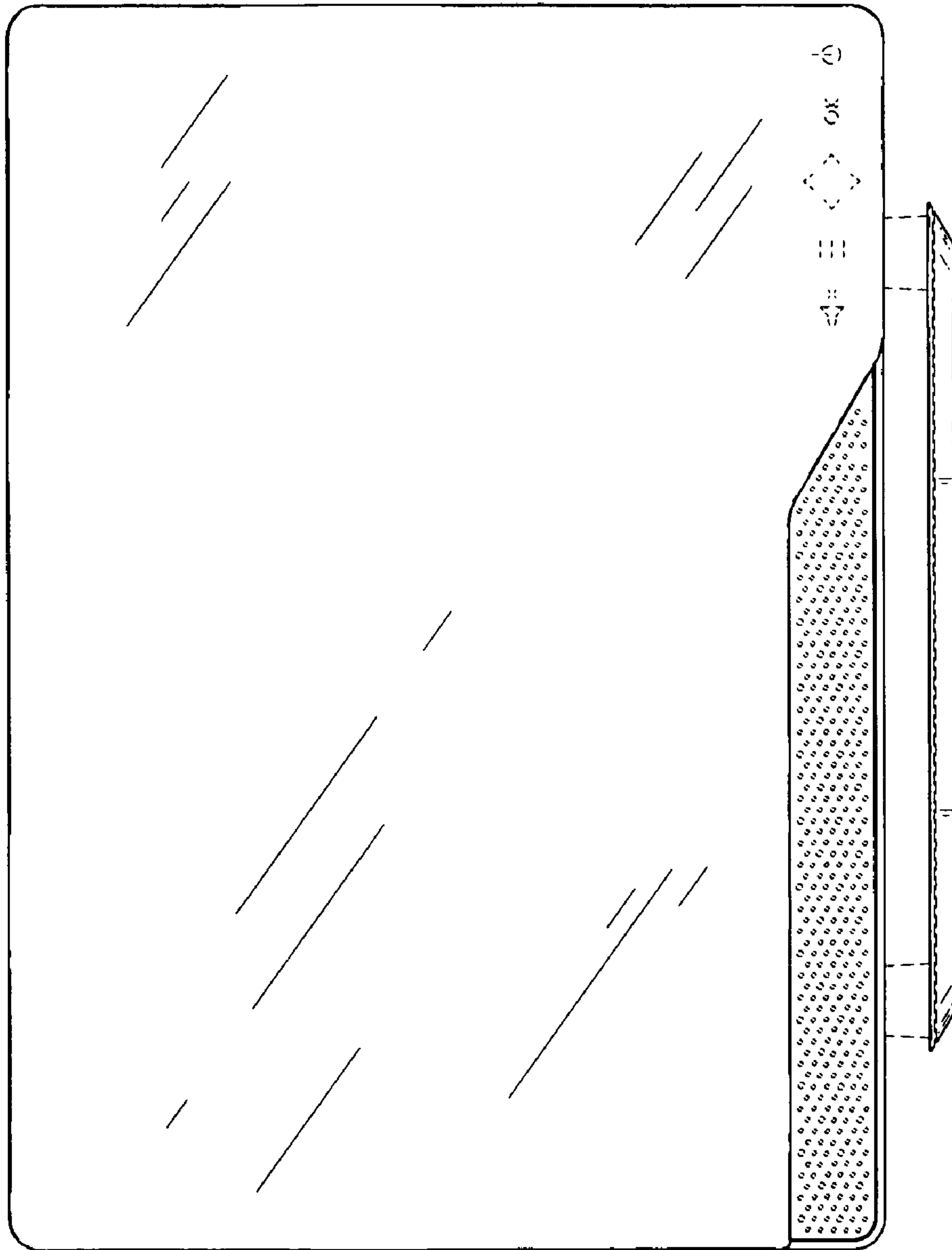

FIG. 2

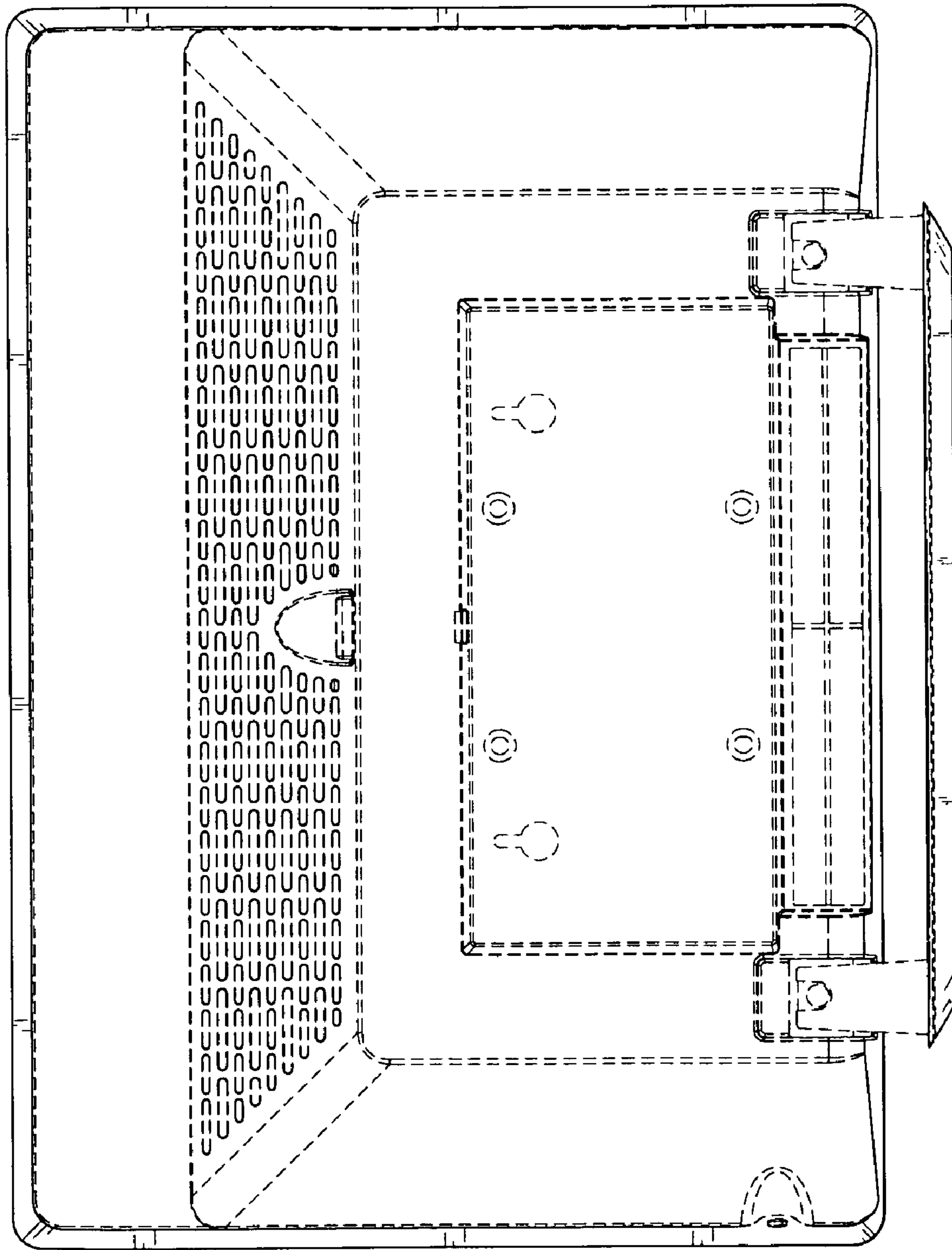

FIG. 3

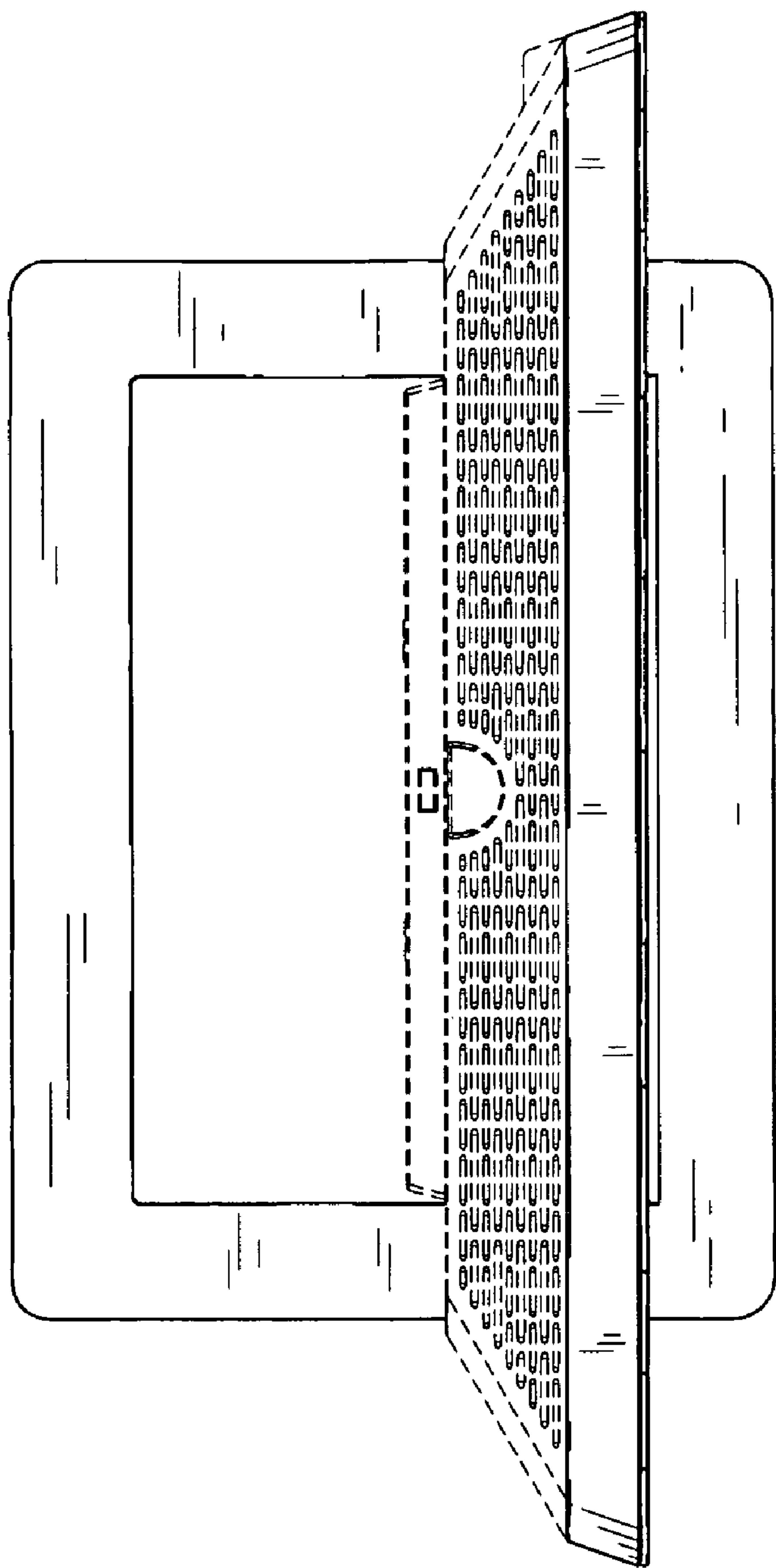

FIG. 4

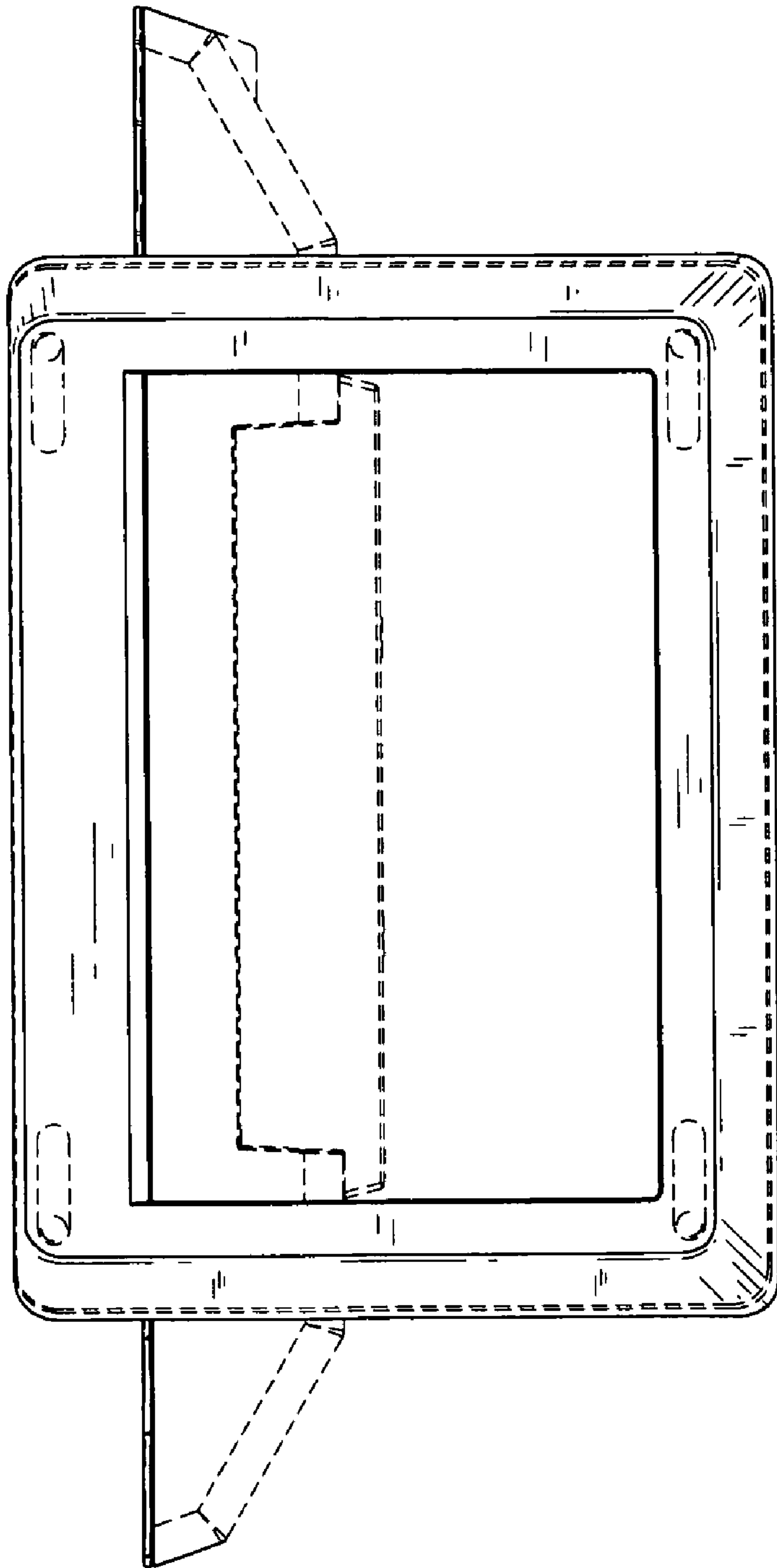
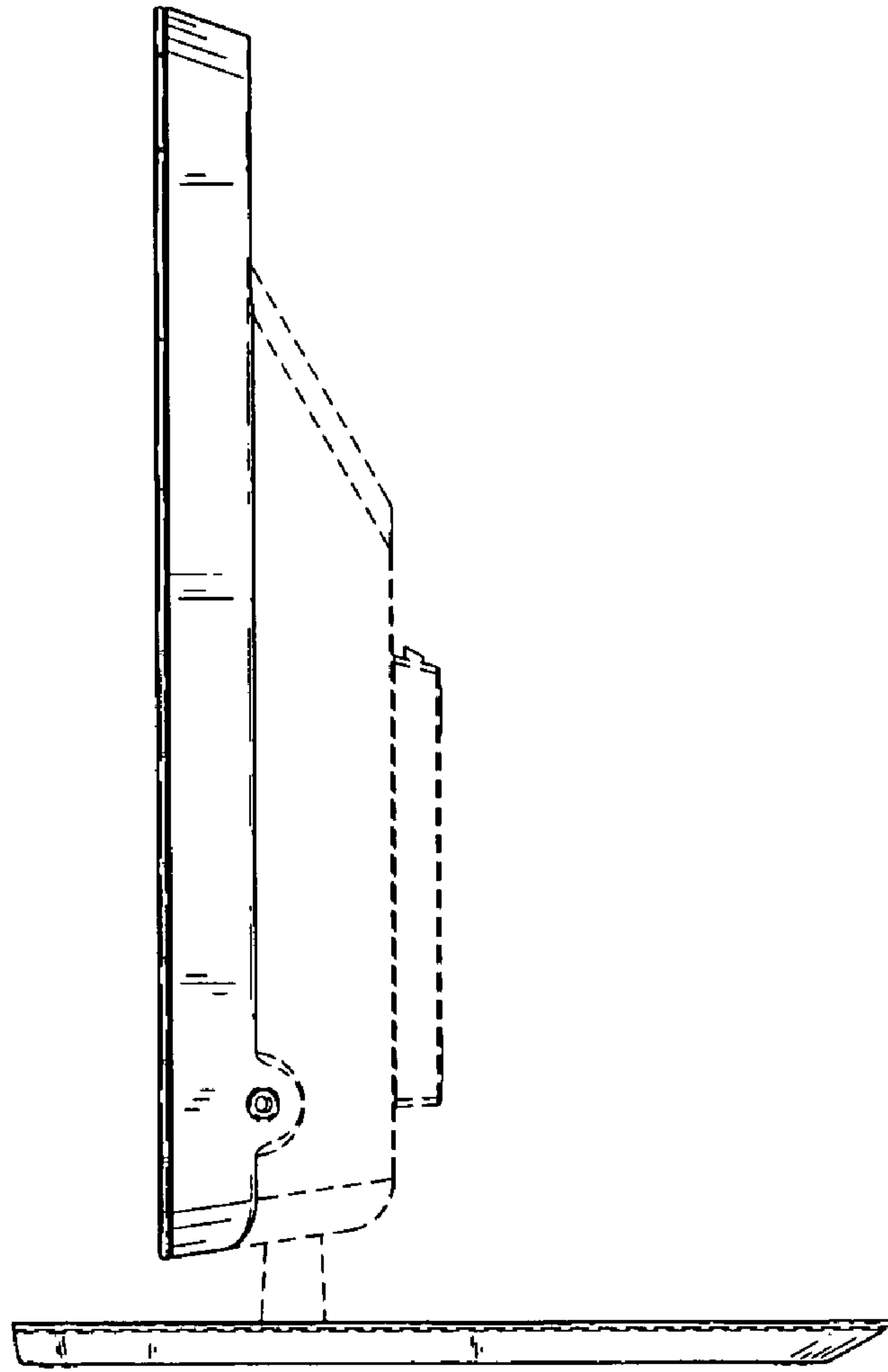
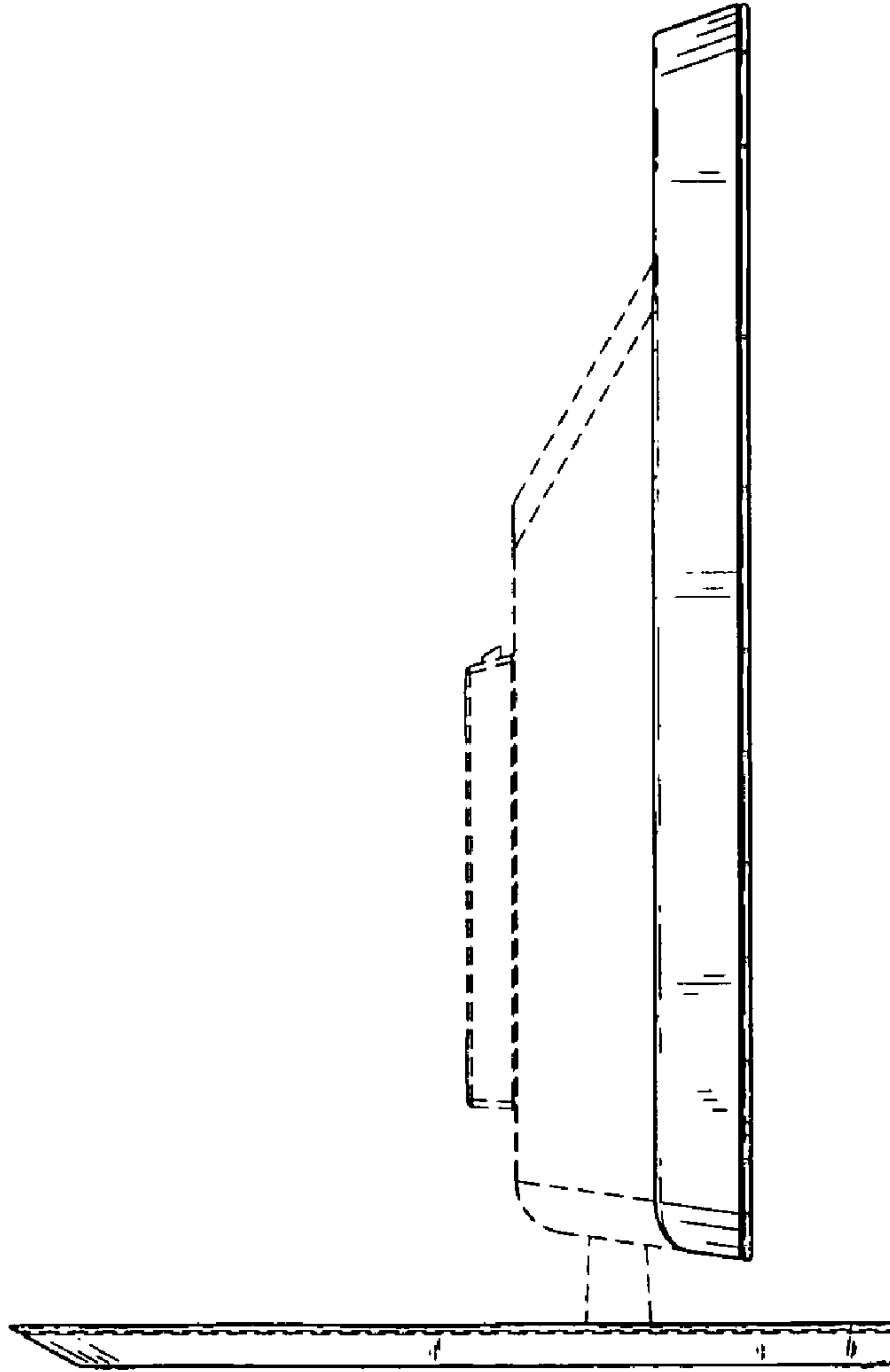

FIG. 5





*FIG. 6*



*FIG. 7*



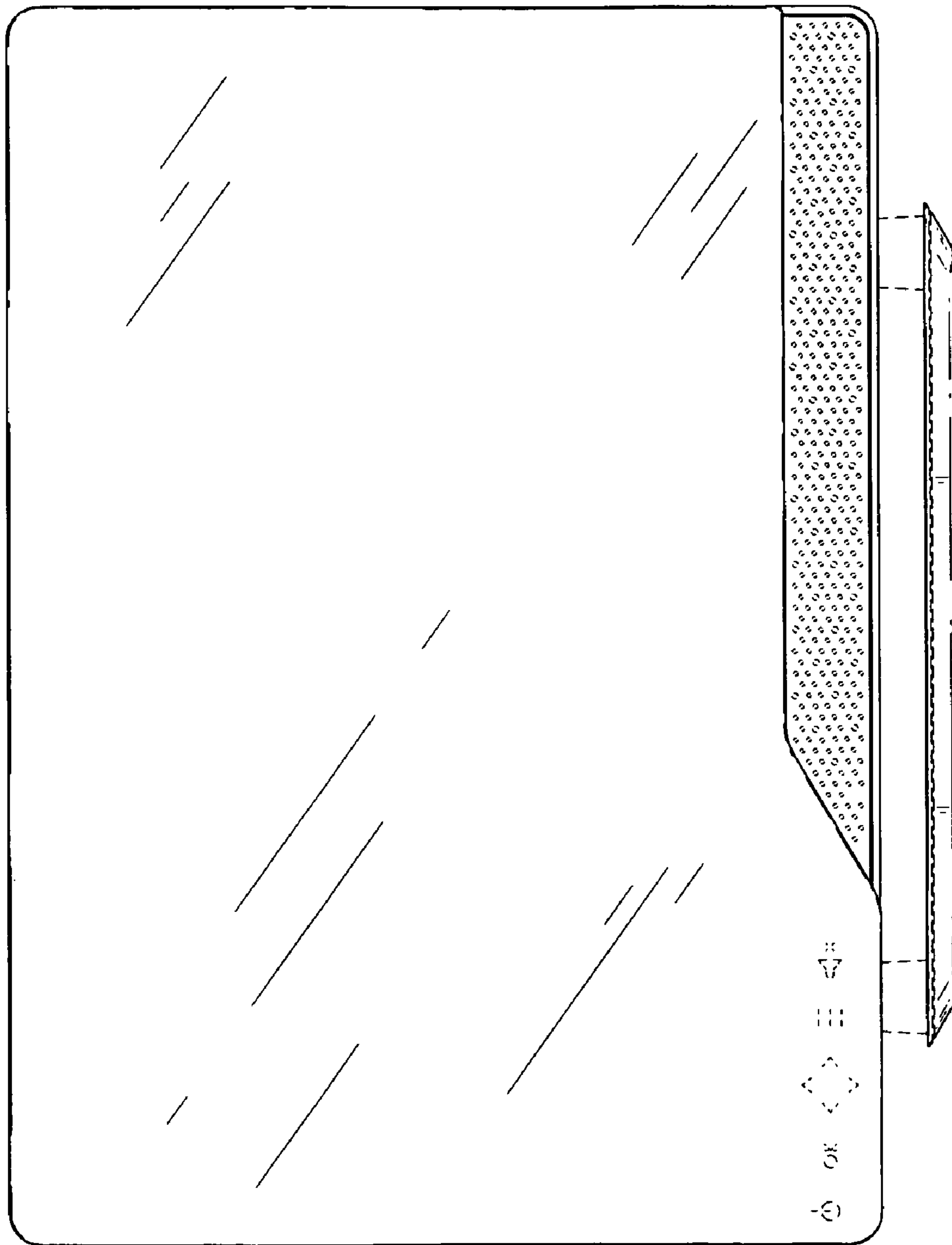

FIG. 8