



US00D609615S

(12) **United States Design Patent**
Kruger et al.

(10) **Patent No.:** **US D609,615 S**

(45) **Date of Patent:** **** Feb. 9, 2010**

(54) **VEHICLE HOOD**

(75) Inventors: **Scott Kruger**, Macomb, MI (US);
Mark T. Allen, Oxford, MI (US); **Ralph V. Gilles**, Leonard, MI (US); **Timothy W. Anness**, Rochester Hills, MI (US)

(73) Assignee: **Chrysler Group LLC**, Auburn Hills, MI (US)

(**) Term: **14 Years**

(21) Appl. No.: **29/333,811**

(22) Filed: **Mar. 16, 2009**

Related U.S. Application Data

(63) Continuation-in-part of application No. 29/304,483, filed on Mar. 3, 2008, now Pat. No. Des. 588,501.

(51) **LOC (9) Cl.** **12-16**

(52) **U.S. Cl.** **D12/173**

(58) **Field of Classification Search** D12/173,
D12/196, 86, 90-92; 180/69.21, 69.2, 69.22
See application file for complete search history.

(56) **References Cited**

U.S. PATENT DOCUMENTS

D430,068 S	8/2000	Castiglione et al.	
D455,372 S	4/2002	Myles et al.	
D466,451 S	12/2002	Trostle et al.	
D503,659 S	4/2005	Matsumoto et al.	
D508,440 S	8/2005	Hall et al.	
D512,666 S *	12/2005	Chiang D12/173

D516,957 S	3/2006	O'Connell et al.	
D536,644 S	2/2007	Shimoguchi et al.	
D537,385 S	2/2007	Shimoguchi et al.	
D543,489 S	5/2007	Gunby	
D551,127 S	9/2007	Kruger et al.	
D564,946 S	3/2008	Kruger et al.	
D572,640 S *	7/2008	Zimmermann et al. D12/173
D579,832 S *	11/2008	Opfer et al. D12/173
D584,501 S	3/2009	Kruger et al.	
D592,574 S *	5/2009	Larson D12/173

* cited by examiner

Primary Examiner—Melody N Brown

(74) *Attorney, Agent, or Firm*—Ralph E. Smith

(57) **CLAIM**

The ornamental design for a vehicle hood, as shown and described.

DESCRIPTION

FIG. 1 is a front perspective view of a vehicle hood showing our new design;

FIG. 2 is a side view thereof;

FIG. 3 is a top view thereof;

FIG. 4 is a front view thereof;

FIG. 5 is a rear view thereof; and,

FIG. 6 is a bottom view thereof.

It will be understood that the broken lines presented in the drawings are for illustration only, and do not form a part of the claimed design.

1 Claim, 6 Drawing Sheets

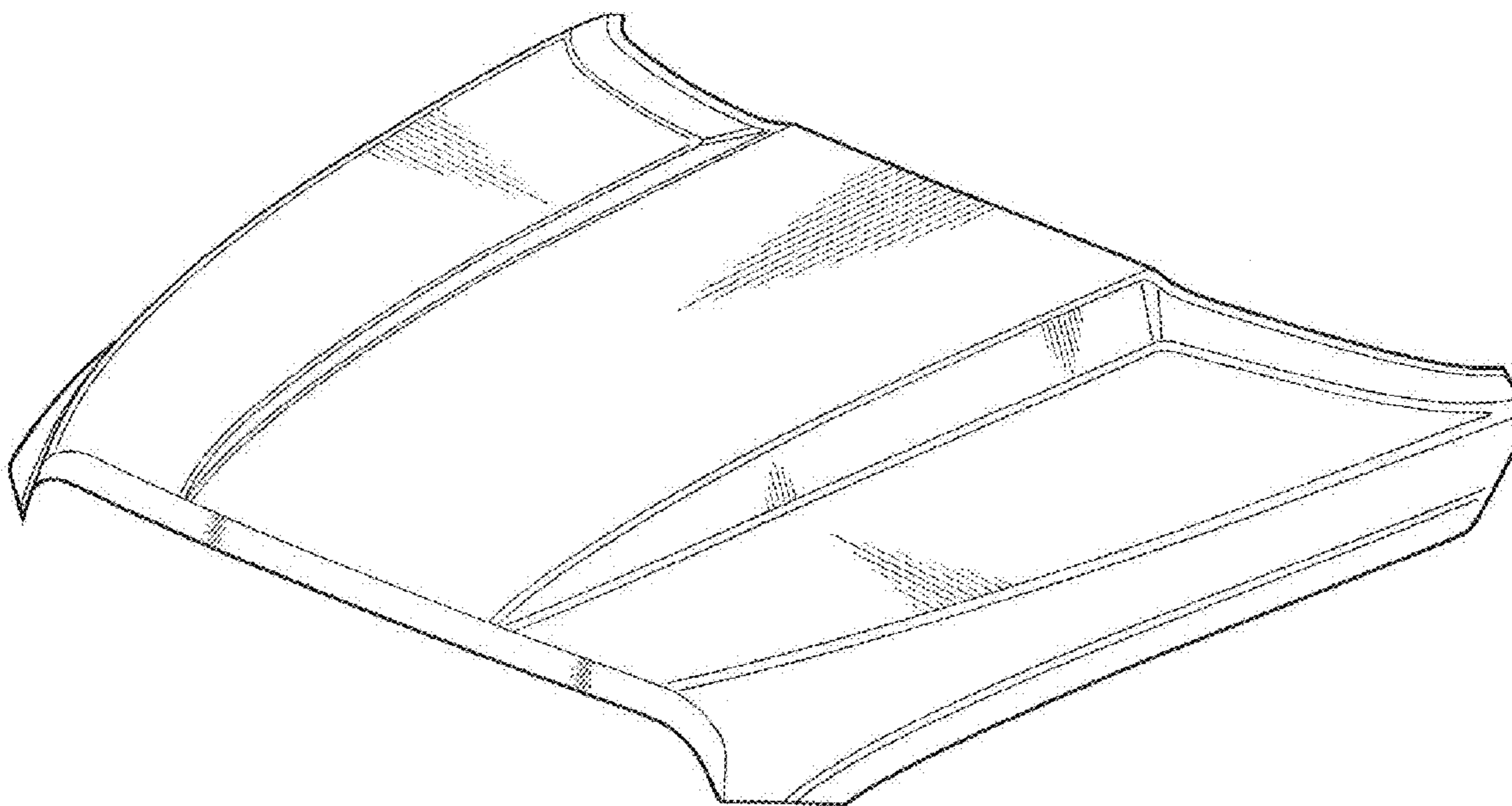

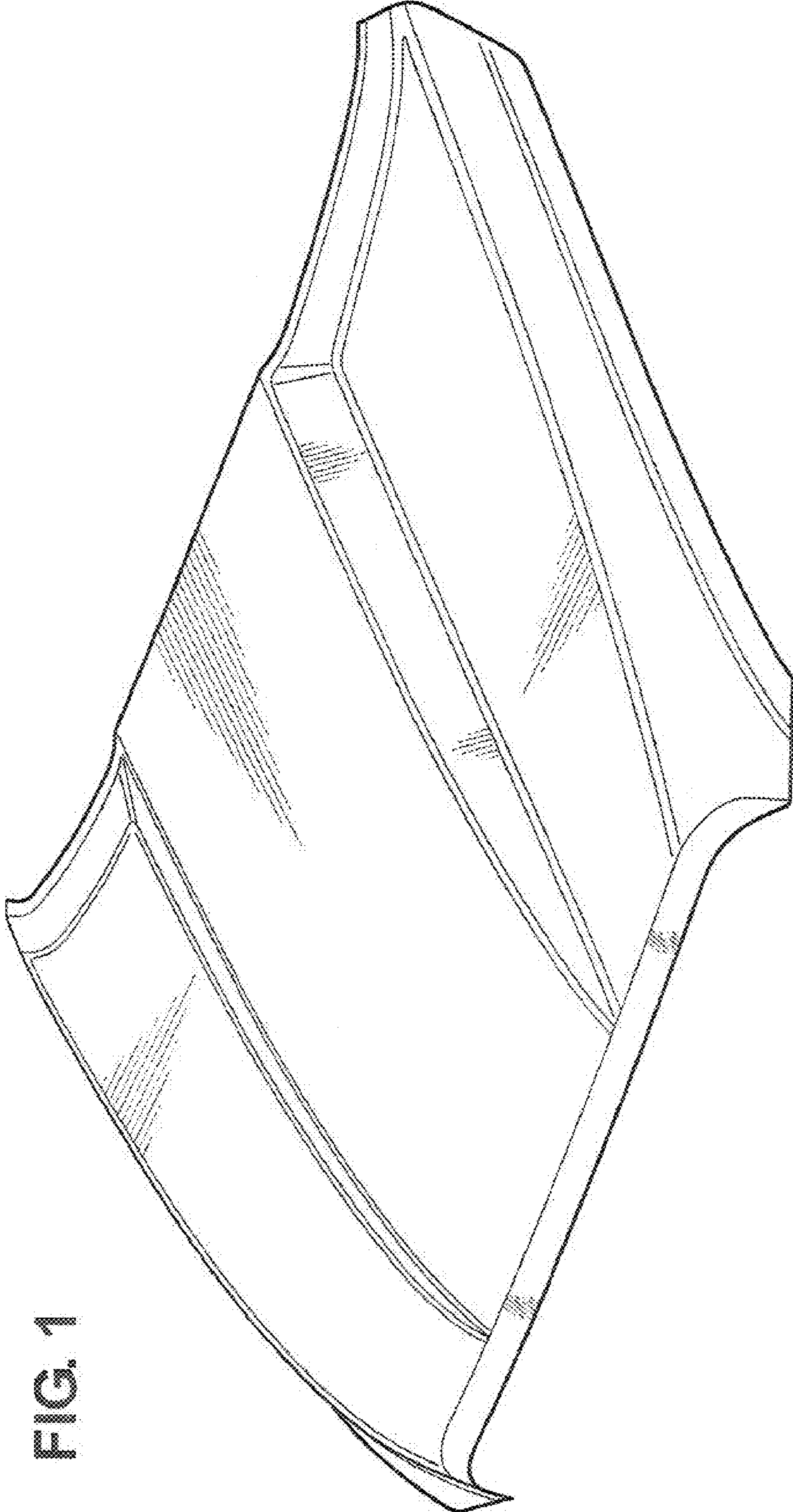

FIG. 1

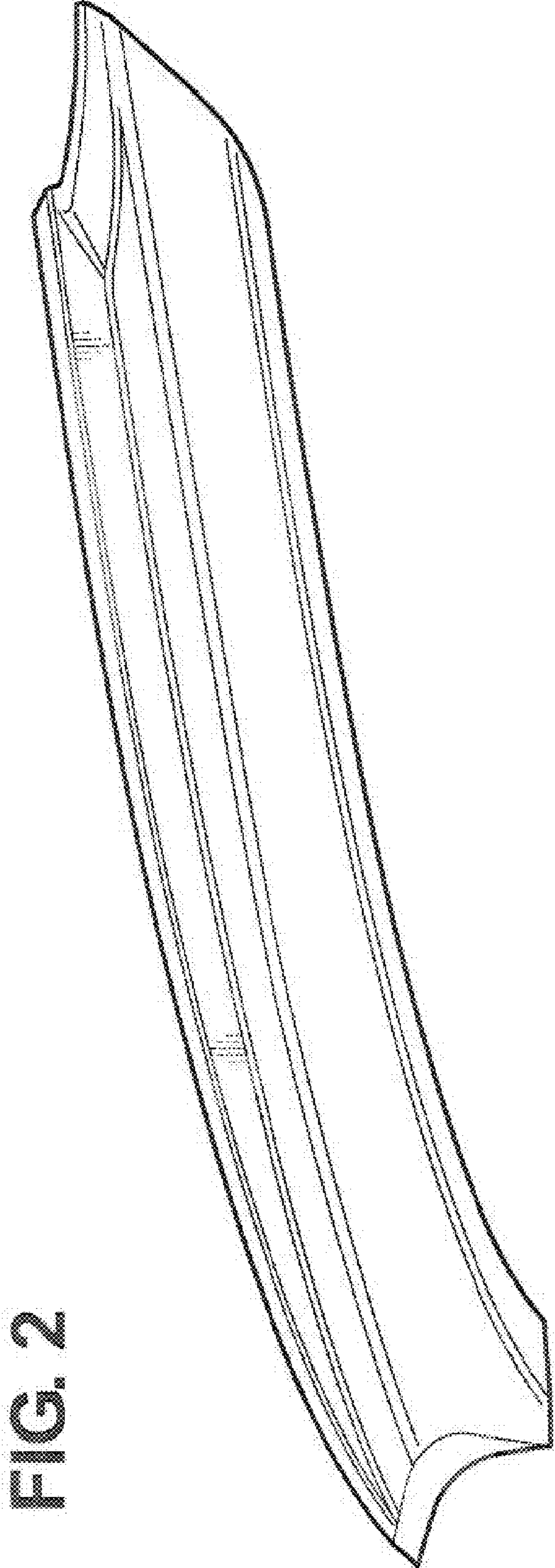

FIG. 2

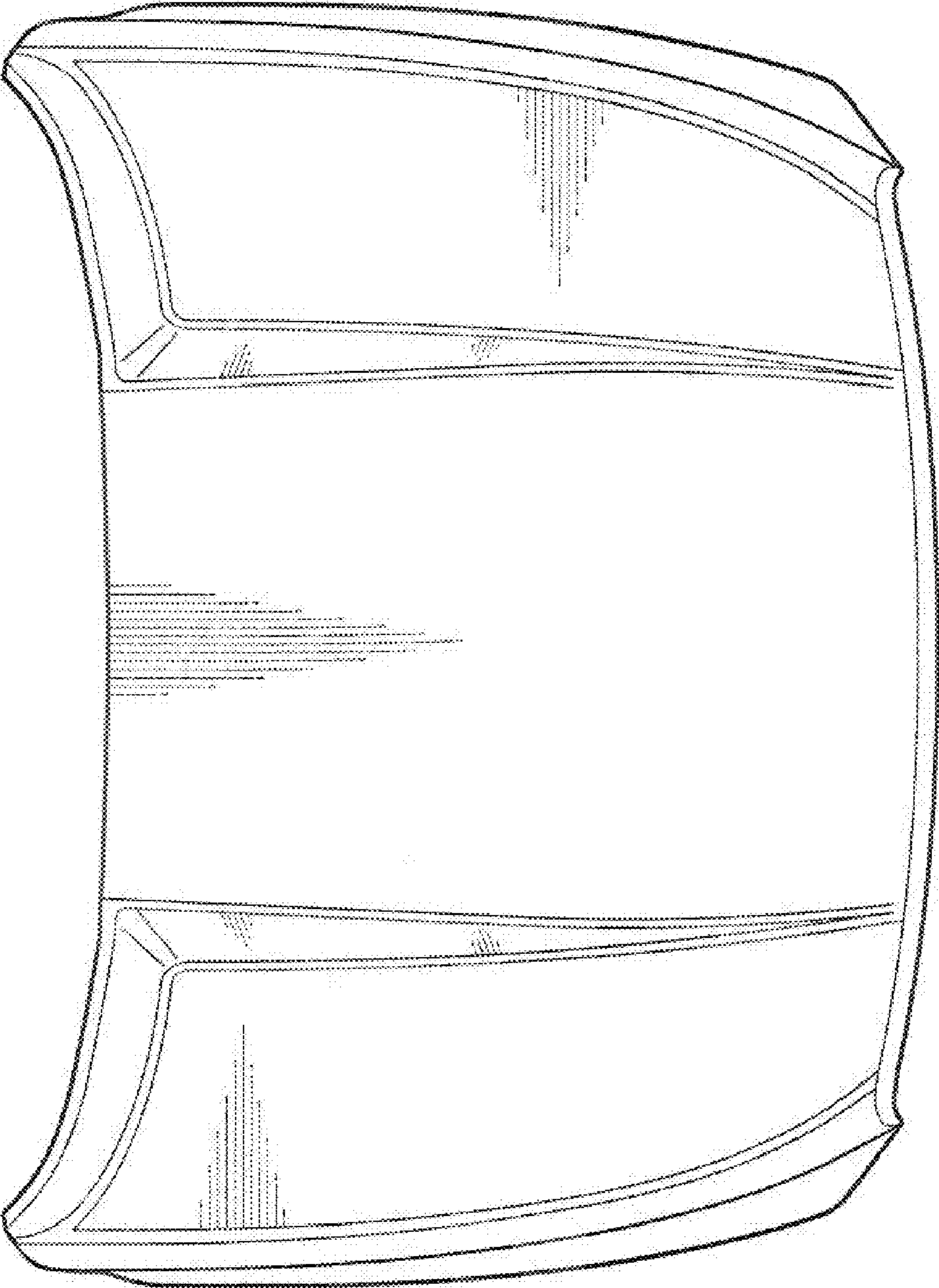

FIG. 3

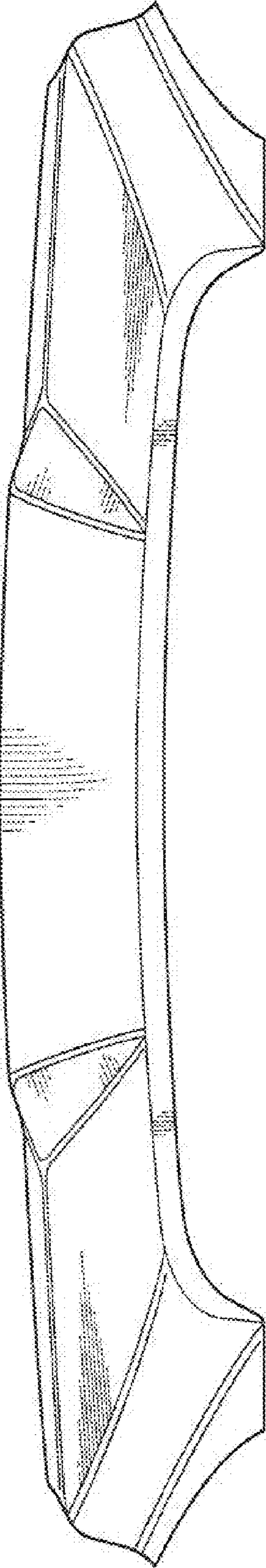

FIG. 4

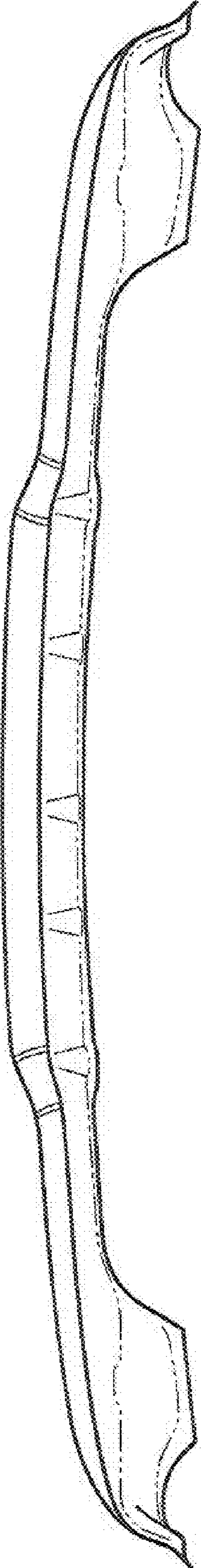

FIG. 5

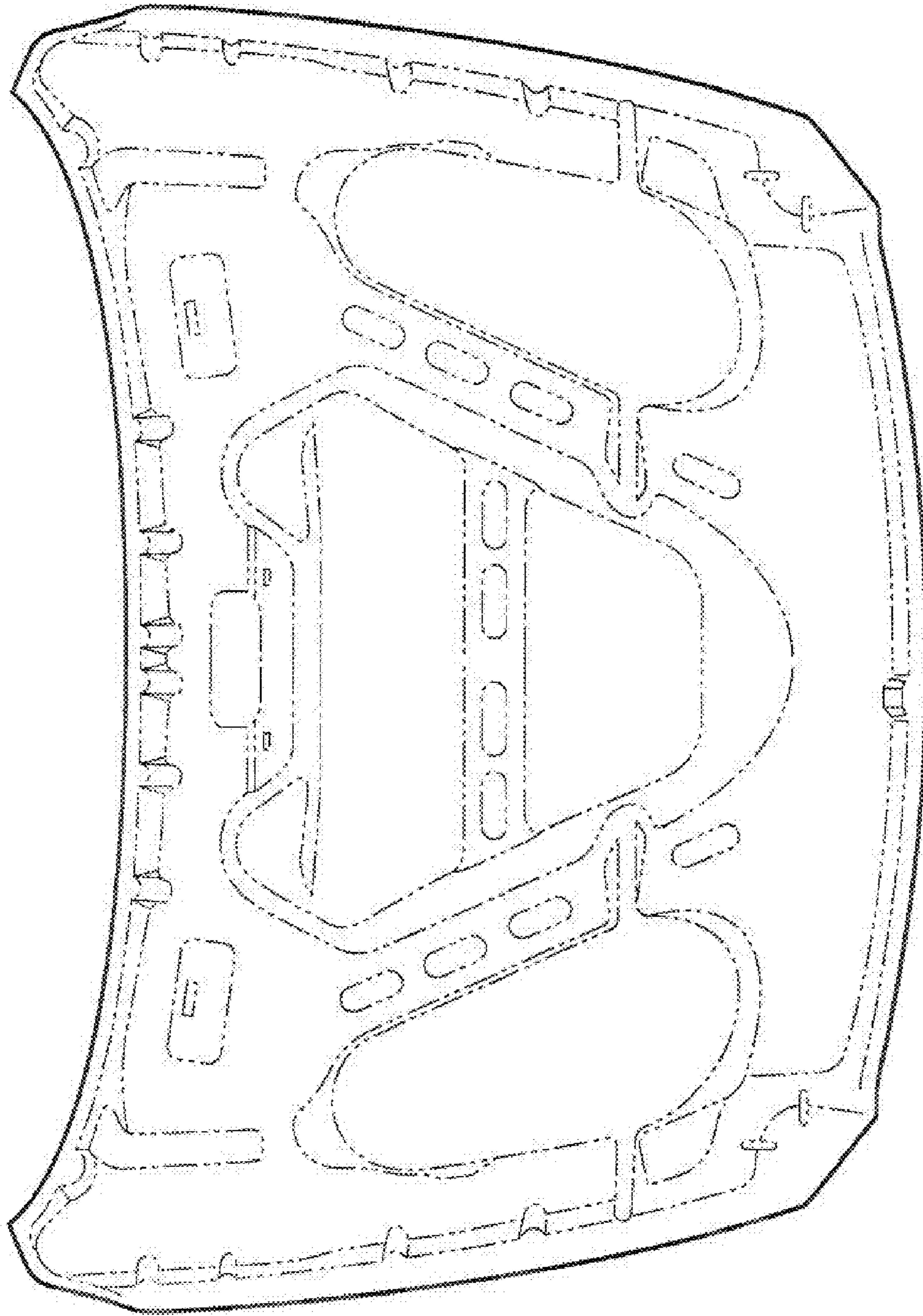

FIG. 6