



US00D609562S

(12) **United States Design Patent**  
**Zimmermann**

(10) **Patent No.:** **US D609,562 S**  
(45) **Date of Patent:** **\*\* Feb. 9, 2010**

(54) **TRANSPARENT BOX FOR BOTTLES**

(75) Inventor: **Kal Zimmermann**, Paris (FR)

(73) Assignee: **Polmos Zyrardow Spolka Z.O.O.**,  
Zyrardow (PL)

(\*\*) Term: **14 Years**

(21) Appl. No.: **29/283,017**

(22) Filed: **Aug. 3, 2007**

(30) **Foreign Application Priority Data**

Feb. 9, 2007 (EM) ..... 000667670-0001

(51) **LOC (9) Cl.** ..... **09-03**

(52) **U.S. Cl.** ..... **D9/432**

(58) **Field of Classification Search** ..... D9/430-433,  
D9/414, 418, 420-423, 435, 560, 561, 517;  
D3/201, 272, 273, 305; 206/278, 297, 299,  
206/320, 339, 433, 769, 770, 775, 776, 781,  
206/782, 822; 229/100, 103.3, 104-106,  
229/107, 108, 108.1, 110, 111, 112, 115,  
229/117.16, 120, 125.015, 120.32, 133.24,  
229/122.29, 124, 160.1, 162.1, 162.6, 163,  
229/182.1, 201, 406, 407, 902, 904, 906,  
229/922, 930, 939, 942

See application file for complete search history.

(56) **References Cited**

U.S. PATENT DOCUMENTS

1,951,831 A \* 3/1934 Lewis ..... 206/277  
2,313,766 A \* 3/1943 Pfanstiehl ..... 206/457  
2,452,629 A \* 11/1948 Bonekamp ..... 426/124  
2,809,745 A \* 10/1957 Bramming ..... 206/586  
3,006,461 A \* 10/1961 McGinnis ..... 206/446  
3,244,272 A \* 4/1966 Beaman et al. .... 206/0.82  
D212,413 S \* 10/1968 Lacoste ..... D9/432  
D258,571 S \* 3/1981 Hirtle ..... D9/560  
D266,489 S \* 10/1982 Toback ..... D9/455  
D276,594 S \* 12/1984 Fahey et al. .... D9/420  
D287,821 S \* 1/1987 Holewinski et al. .... D9/414  
D304,686 S \* 11/1989 Jarrin ..... D9/782

D309,416 S \* 7/1990 Britz ..... D8/104  
D317,717 S \* 6/1991 Carol ..... D9/739  
D328,956 S \* 8/1992 Leonard ..... D26/104  
D331,362 S \* 12/1992 Andersson et al. .... D9/417  
D362,180 S \* 9/1995 Haines ..... D9/424  
5,605,242 A \* 2/1997 Hwang ..... 220/8  
D429,148 S \* 8/2000 Seidler ..... D9/418  
D434,648 S \* 12/2000 Li et al. .... D9/415  
D463,746 S \* 10/2002 de Baschmakoff ..... D9/500  
D464,883 S \* 10/2002 Weinstein et al. .... D9/430  
D467,038 S \* 12/2002 Restrepo ..... D28/85  
D489,974 S \* 5/2004 Elgebrant ..... D9/416

(Continued)

FOREIGN PATENT DOCUMENTS

DE 3325033 A1 \* 3/1984

*Primary Examiner*—Robert M Spear

*Assistant Examiner*—Karen Acker

(74) *Attorney, Agent, or Firm*—Jeffer Mangels Butler &  
Marmaro LLP

(57) **CLAIM**

The ornamental design for the transparent box for bottles, as shown and described.

**DESCRIPTION**

FIG. 1 is a top front corner perspective view of a transparent box for bottles of the present invention;

FIG. 2 is a top front corner perspective view thereof showing the handle in an alternative position;

FIG. 3 is a rear elevational view thereof;

FIG. 4 is a left side elevational view thereof;

FIG. 5 is a front elevational view thereof;

FIG. 6 is a right side elevational view thereof; and,

FIG. 7 is a top plan view thereof.

The broken lines in the drawings represent unclaimed environmental subject matter.

**1 Claim, 4 Drawing Sheets**

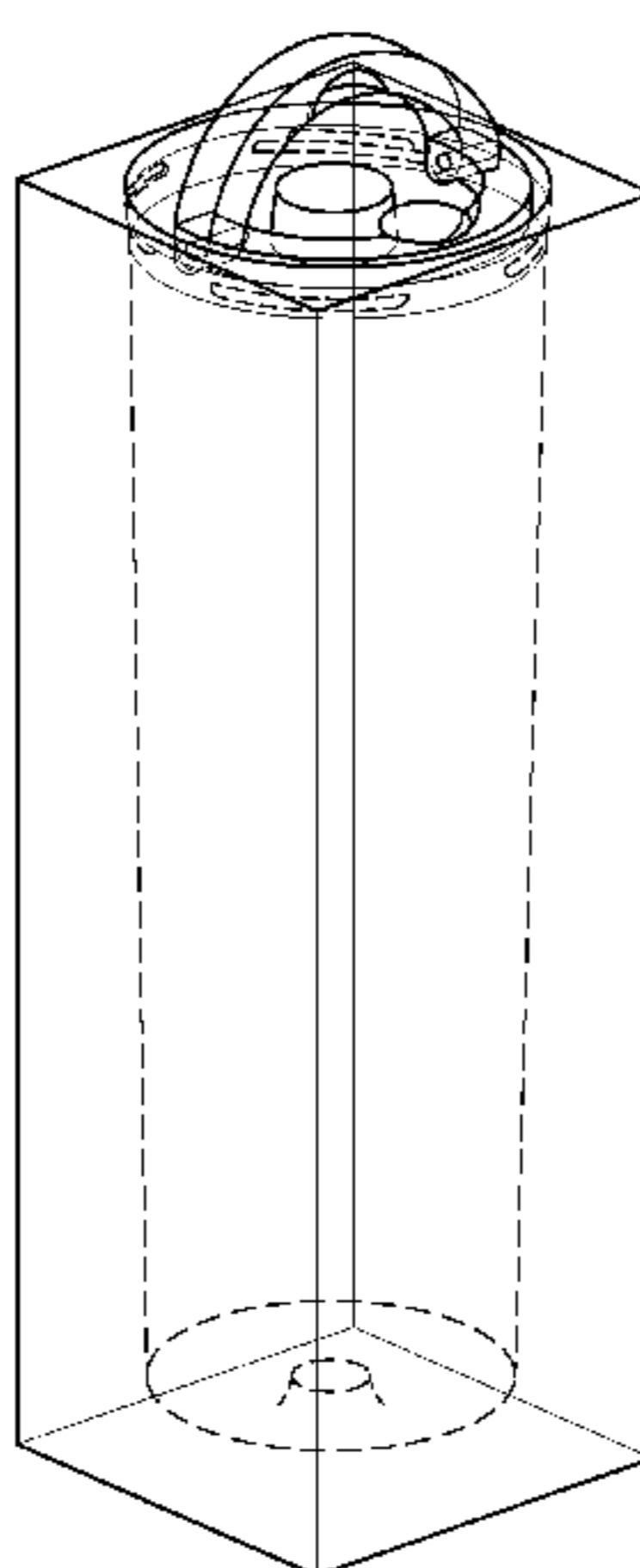

# US D609,562 S

Page 2

---

## U.S. PATENT DOCUMENTS

D495,252 S *	8/2004	Poole .....	D9/432	D539,662 S *	4/2007	Sanchez Lascaux .....	D9/560
D499,341 S *	12/2004	Lovison .....	D9/529	D547,201 S *	7/2007	Zeller .....	D9/716
D518,291 S *	4/2006	Zou et al. ....	D3/255	D553,011 S *	10/2007	Nouvel .....	D9/761
D519,829 S *	5/2006	Campo .....	D9/418	D558,451 S *	1/2008	Roesler .....	D3/302
D526,206 S *	8/2006	Varlet .....	D9/560	D558,978 S *	1/2008	Roesler .....	D3/302
D531,043 S *	10/2006	Houtart et al. ....	D9/560	D579,336 S *	10/2008	Gurciniene .....	D9/529
D532,937 S *	11/2006	Noh .....	D28/76	2004/0226859 A1 *	11/2004	Lo Duca .....	206/775

\* cited by examiner

*FIG. 1*

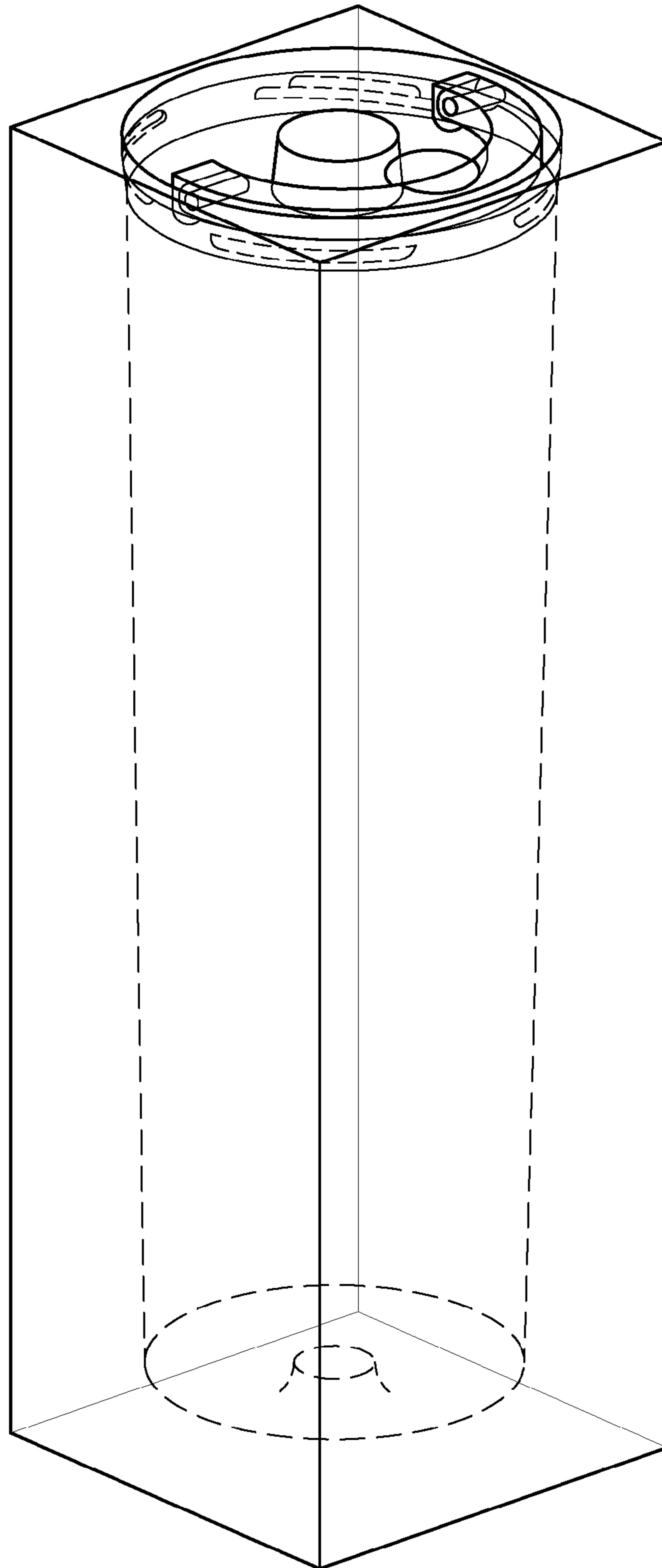

*FIG. 2*

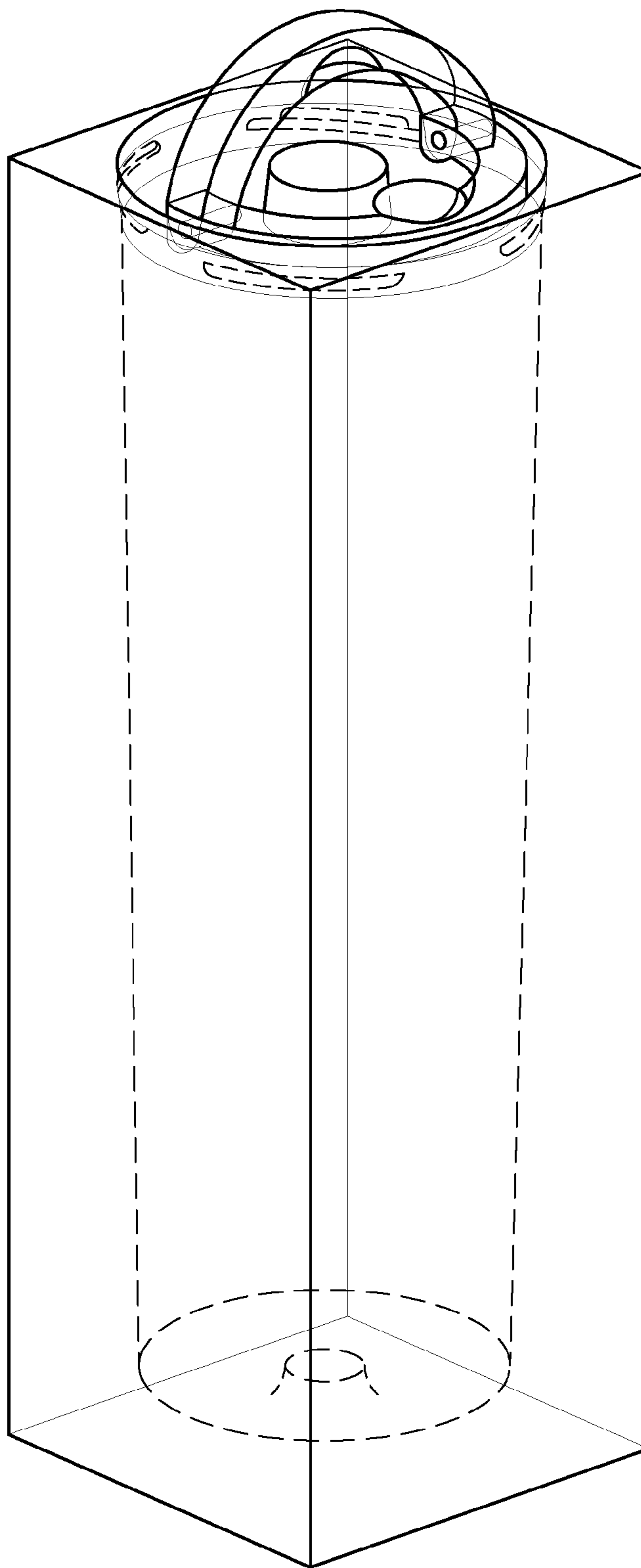

FIG. 7

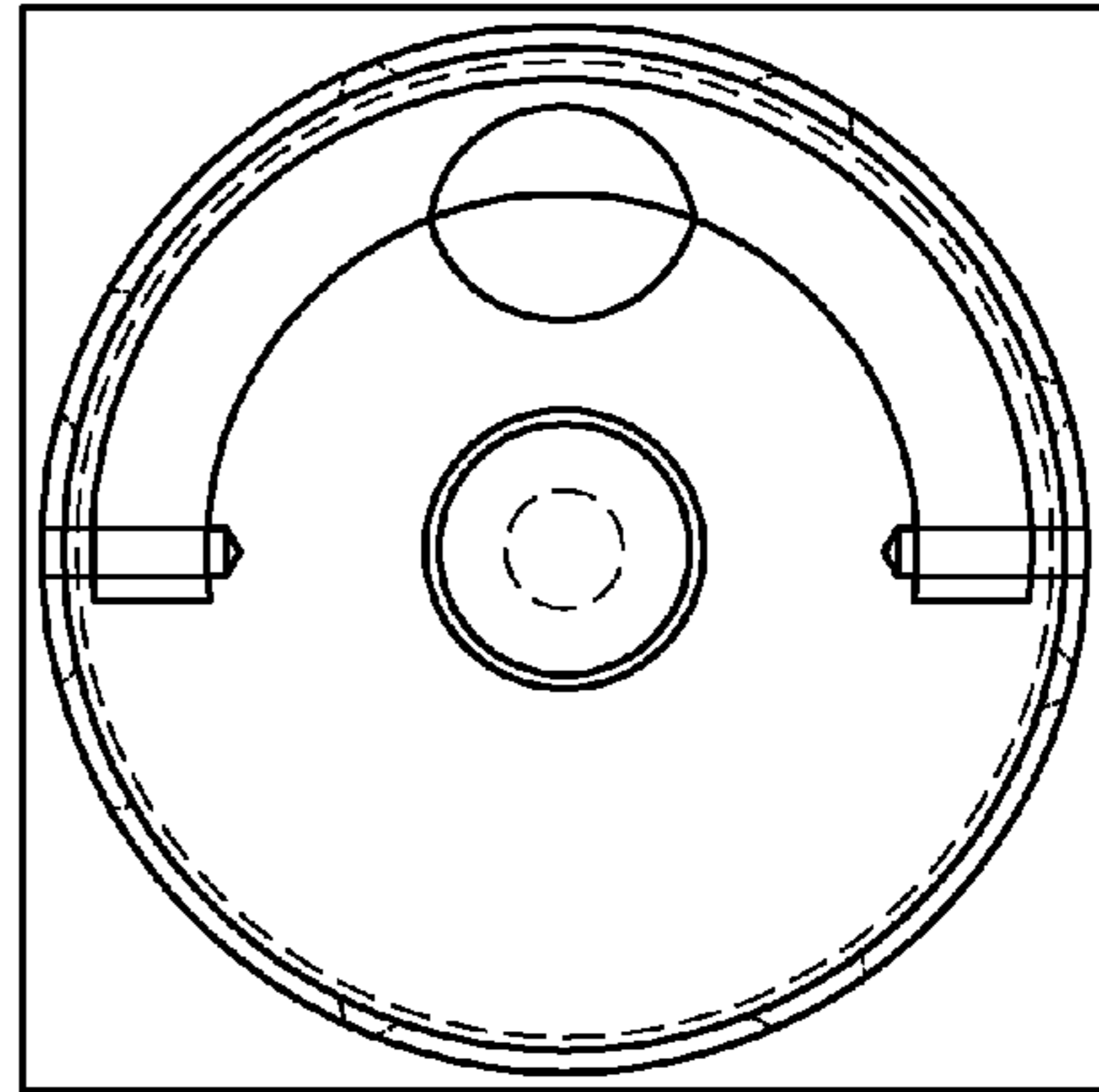

FIG. 3

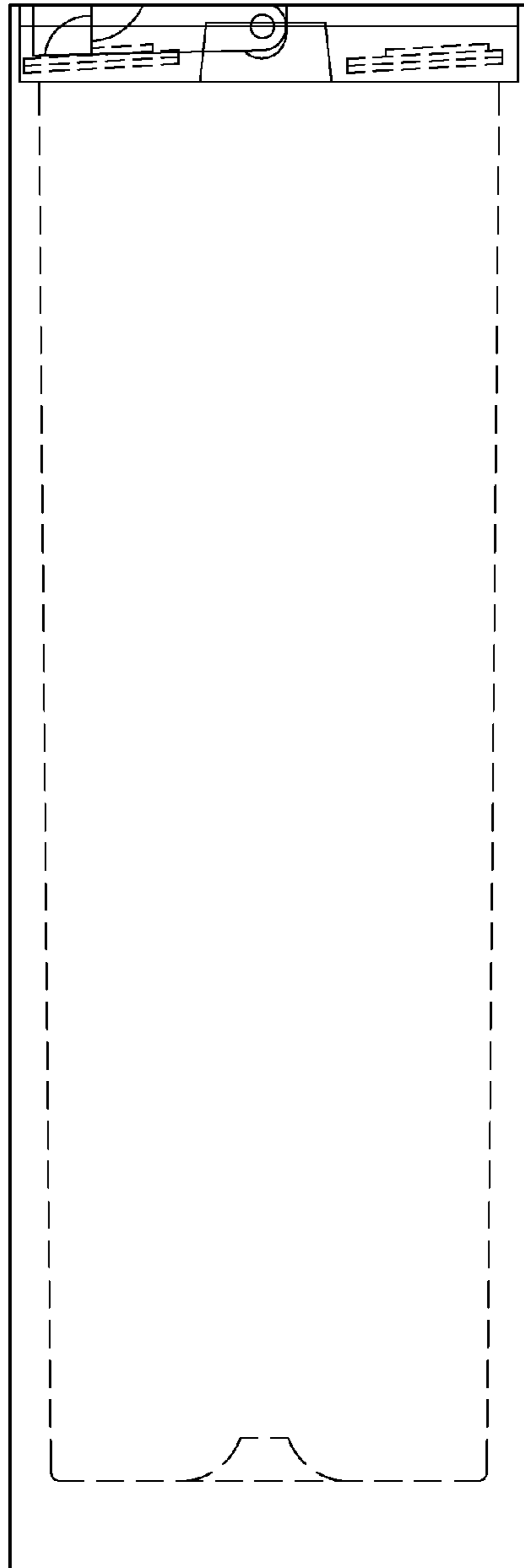
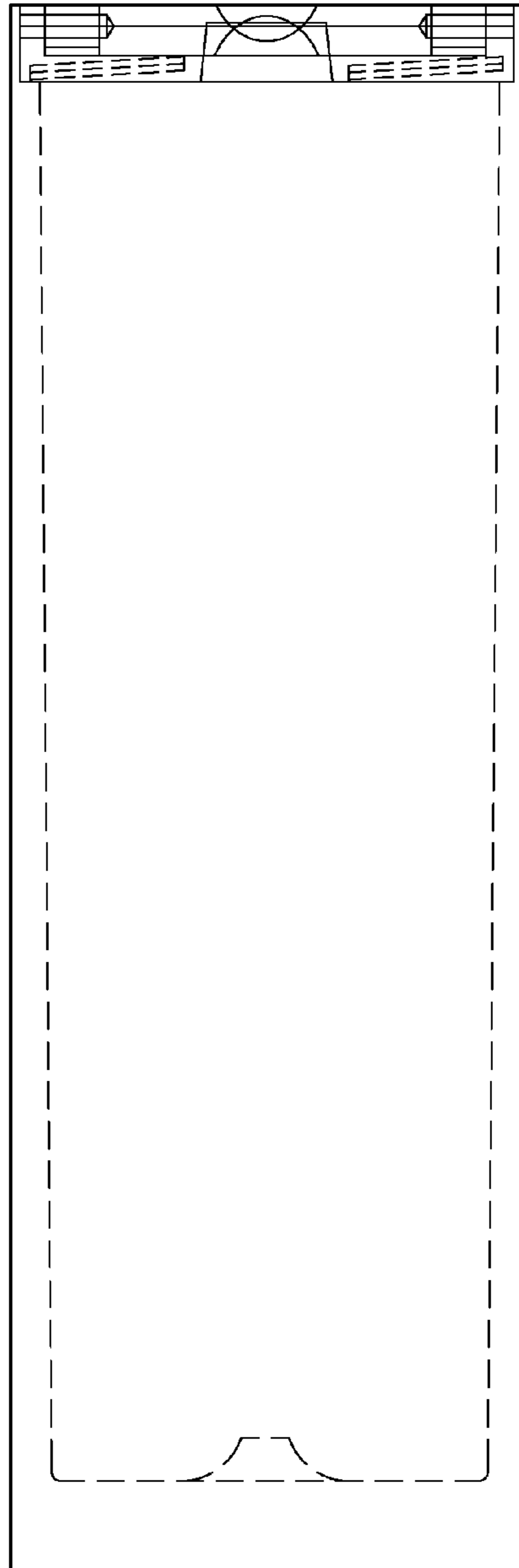
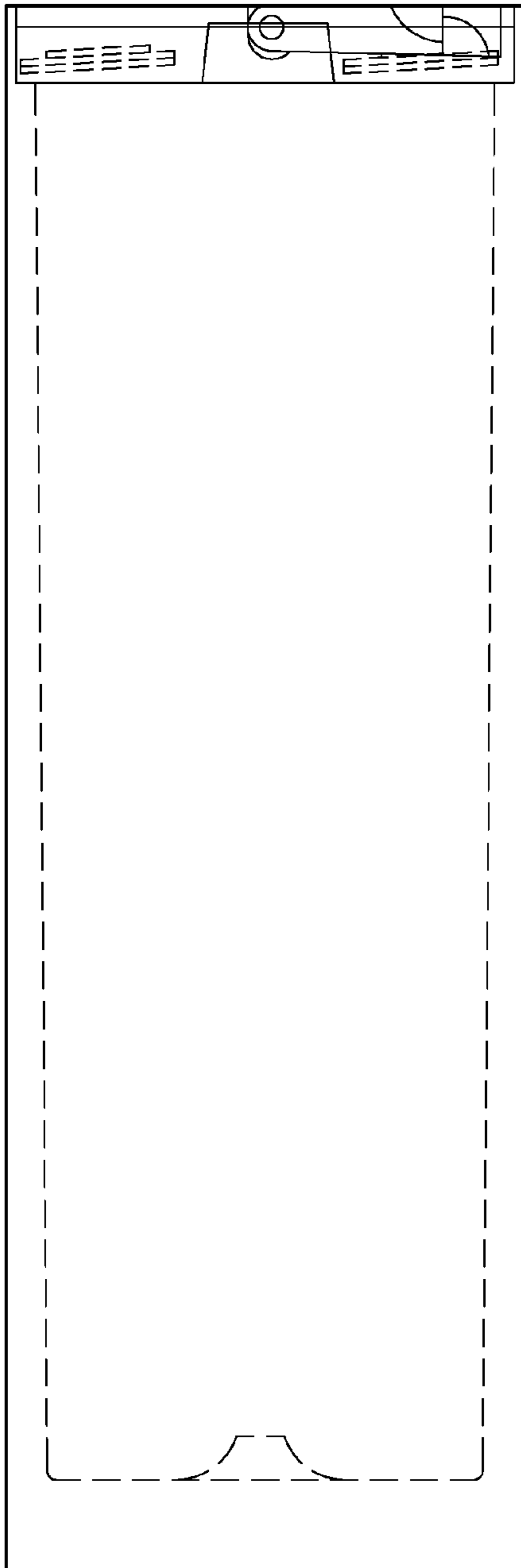

FIG. 4



*FIG. 5*



*FIG. 6*

