



US00D609493S

(12) **United States Design Patent**  
**Dreyer et al.**

(10) **Patent No.:** **US D609,493 S**

(45) **Date of Patent:** **\*\* Feb. 9, 2010**

(54) **DISPLAY AND SALES EQUIPMENT**

(75) Inventors: **Alena Dreyer, Arlöv (SE); William Ronaes Dreyer, Arlöv (SE)**

(73) Assignee: **Proffi Nordic HB, Malmo (SE)**

(\*\*) Term: **14 Years**

(21) Appl. No.: **29/340,178**

(22) Filed: **Jul. 14, 2009**

(30) **Foreign Application Priority Data**

Jan. 15, 2009	(EM)	.....	001070171-0001
Jan. 15, 2009	(EM)	.....	001070171-0002
Jan. 15, 2009	(EM)	.....	001070171-0003

(51) **LOC (9) Cl.** ..... **06-04**

(52) **U.S. Cl.** ..... **D6/407**

(58) **Field of Classification Search** ..... D6/332,  
D6/396, 336, 407; D14/302-307, 129, 371,  
D14/900; 211/86.01, 90.01, 180; 345/156,  
345/173

See application file for complete search history.

(56) **References Cited**

**U.S. PATENT DOCUMENTS**

D366,975 S *	2/1996	Kaga	.....	D6/470
D373,584 S *	9/1996	Anand	.....	D14/126
D429,401 S *	8/2000	Sato et al.	.....	D99/28
D501,557 S *	2/2005	Collins et al.	.....	D24/186
D532,782 S *	11/2006	Russo et al.	.....	D14/307
D535,109 S *	1/2007	Palmer	.....	D6/312
D565,044 S *	3/2008	Witts et al.	.....	D14/307
D574,377 S *	8/2008	Derocher et al.	.....	D14/307
D587,254 S *	2/2009	Morello	.....	D14/239
D587,255 S *	2/2009	Morello	.....	D14/239

D587,257 S *	2/2009	Morello	.....	D14/239
D590,387 S *	4/2009	Chen	.....	D14/307
D597,975 S *	8/2009	Ohno	.....	D14/126
D598,056 S *	8/2009	Labeledz et al.	.....	D21/325

\* cited by examiner

*Primary Examiner*—Elizabeth A Albert

*Assistant Examiner*—Kelley A Donnelly

(74) *Attorney, Agent, or Firm*—Capitol City TechLaw

(57) **CLAIM**

The ornamental design for a display and sales equipment, as shown and described.

**DESCRIPTION**

FIG. 1 is a perspective view of an embodiment of a display and sales equipment showing our new design;

FIG. 2 is a front elevational view thereof;

FIG. 3 is a rear elevational view thereof;

FIG. 4 is a top plan view thereof;

FIG. 5 is a bottom plan view thereof;

FIG. 6 is a left side elevational view thereof, the right side elevational view being a mirror image thereof;

FIG. 7 is a perspective view of another embodiment of a display and sales equipment showing our new design;

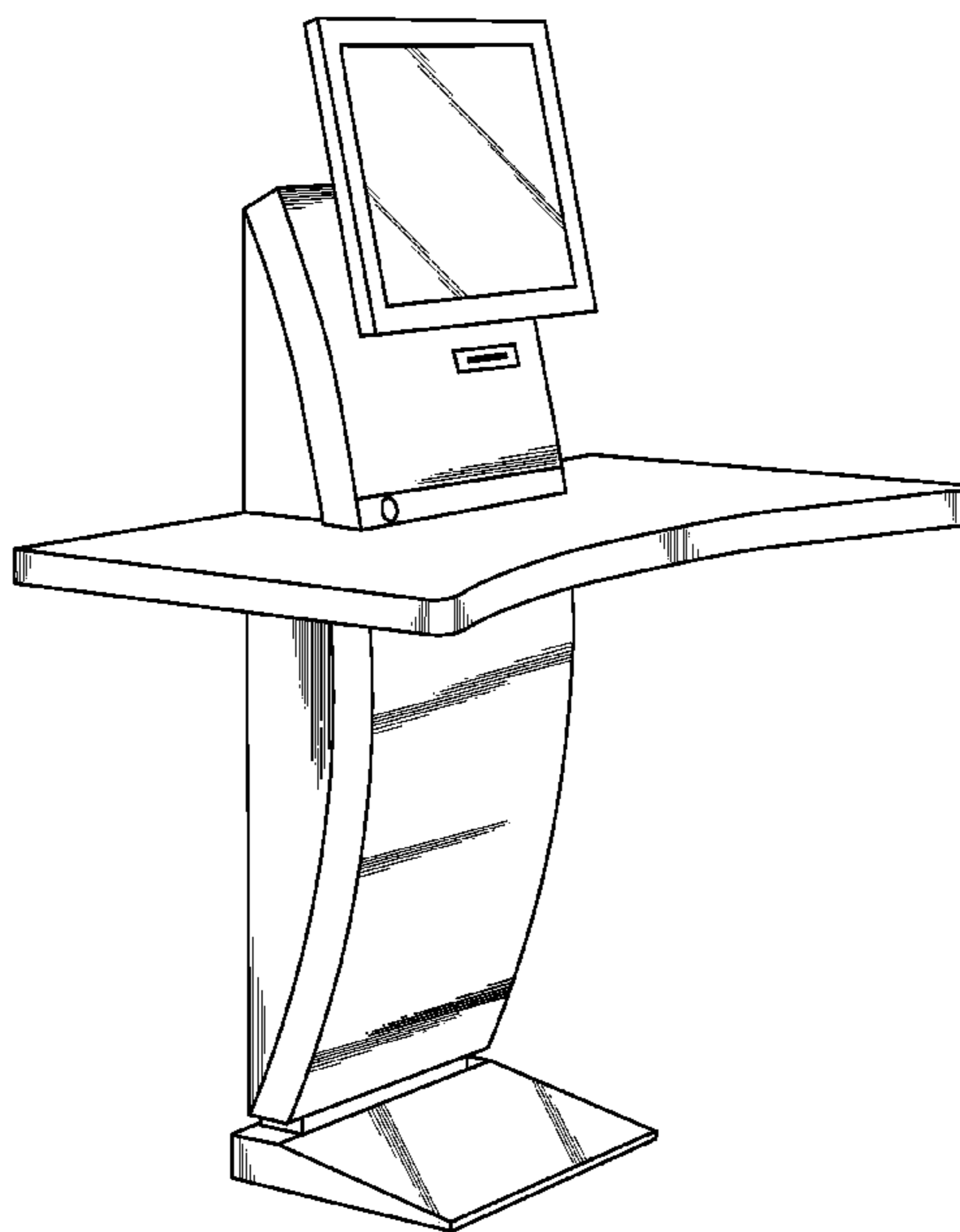
FIG. 8 is a front elevational view thereof, the rear elevational view being an identical image thereof;

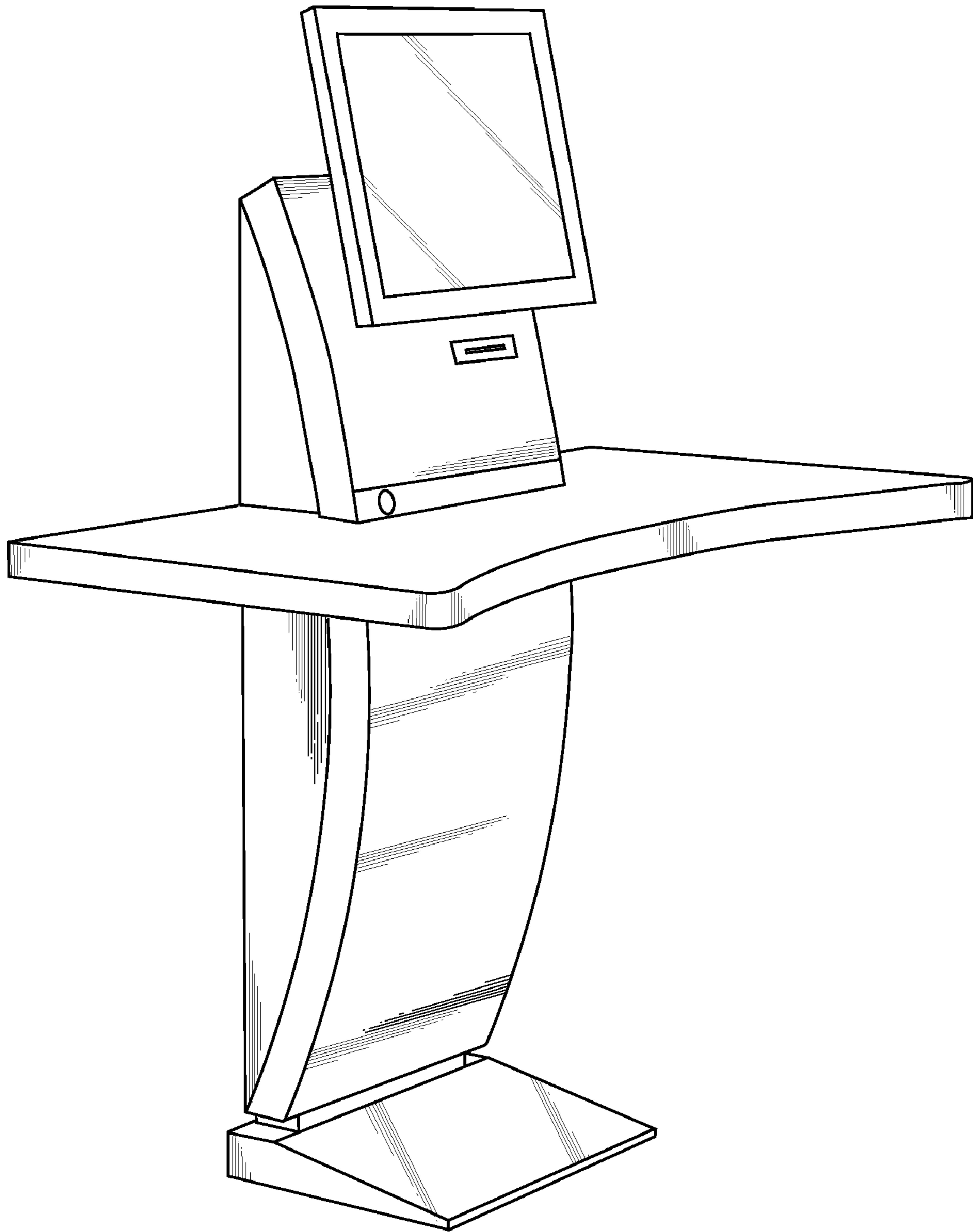
FIG. 9 is a top plan view thereof;

FIG. 10 is a bottom plan view thereof; and,

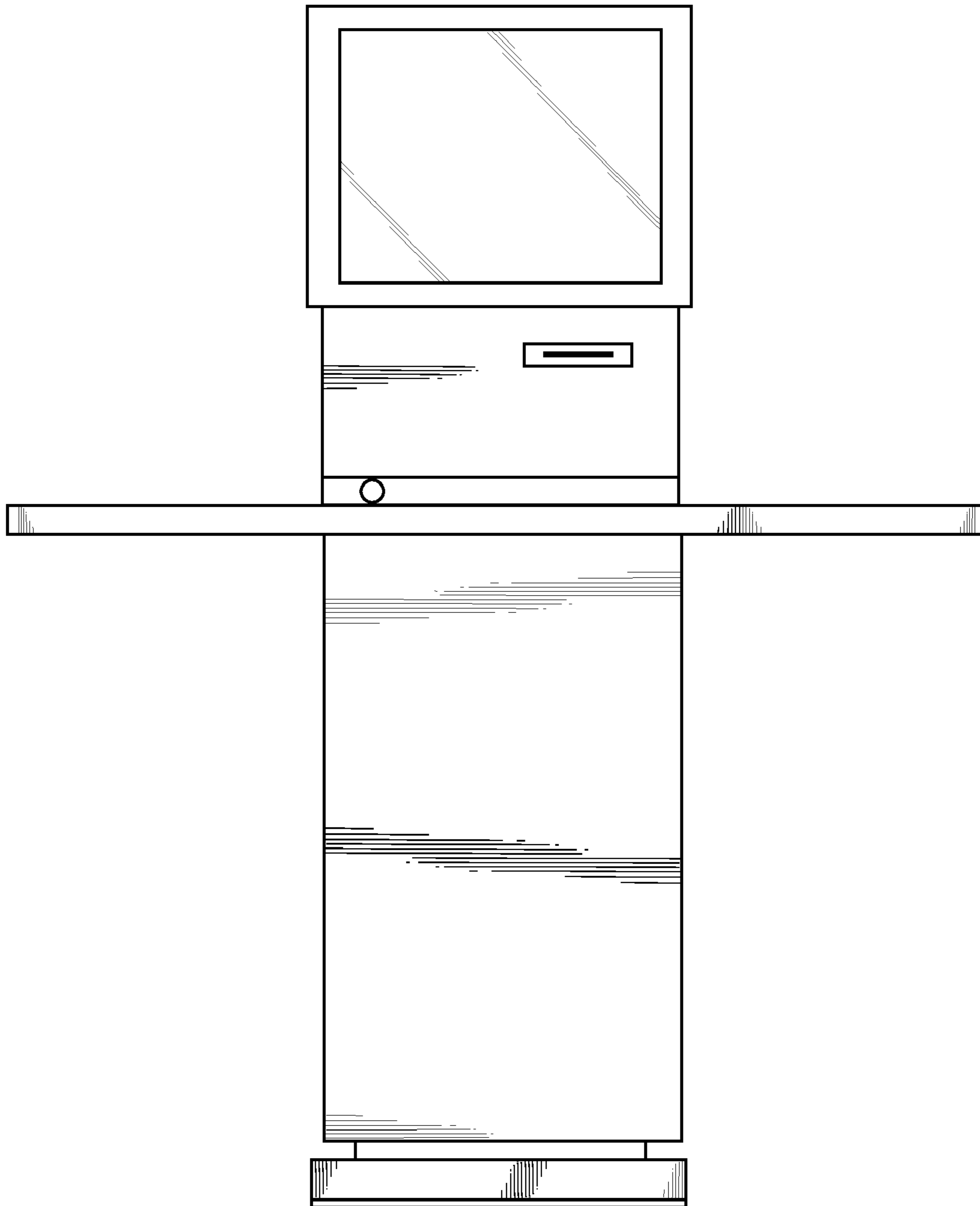
FIG. 11 is a left side elevational view thereof, the right side elevational view being a mirror image thereof.

**1 Claim, 11 Drawing Sheets**

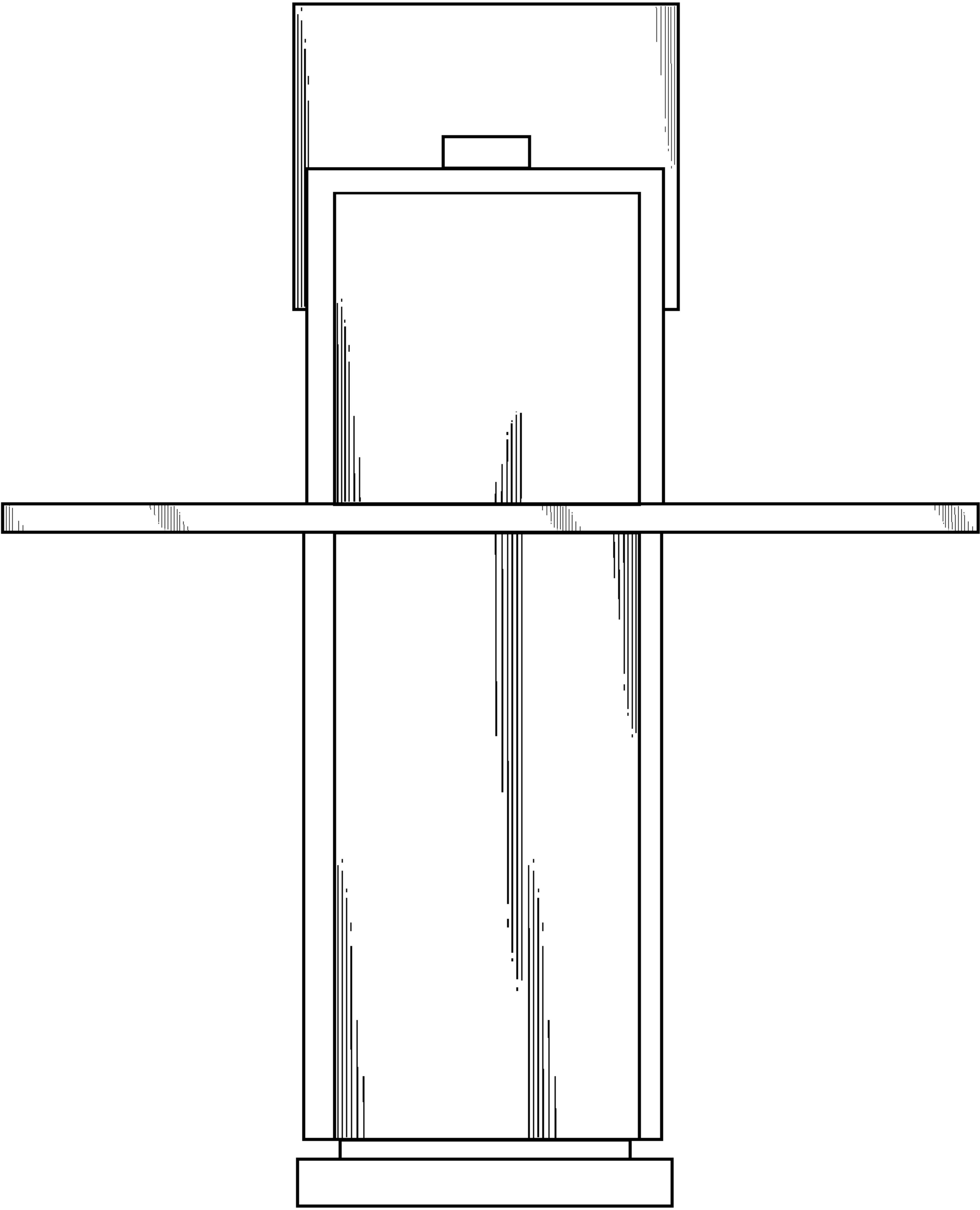




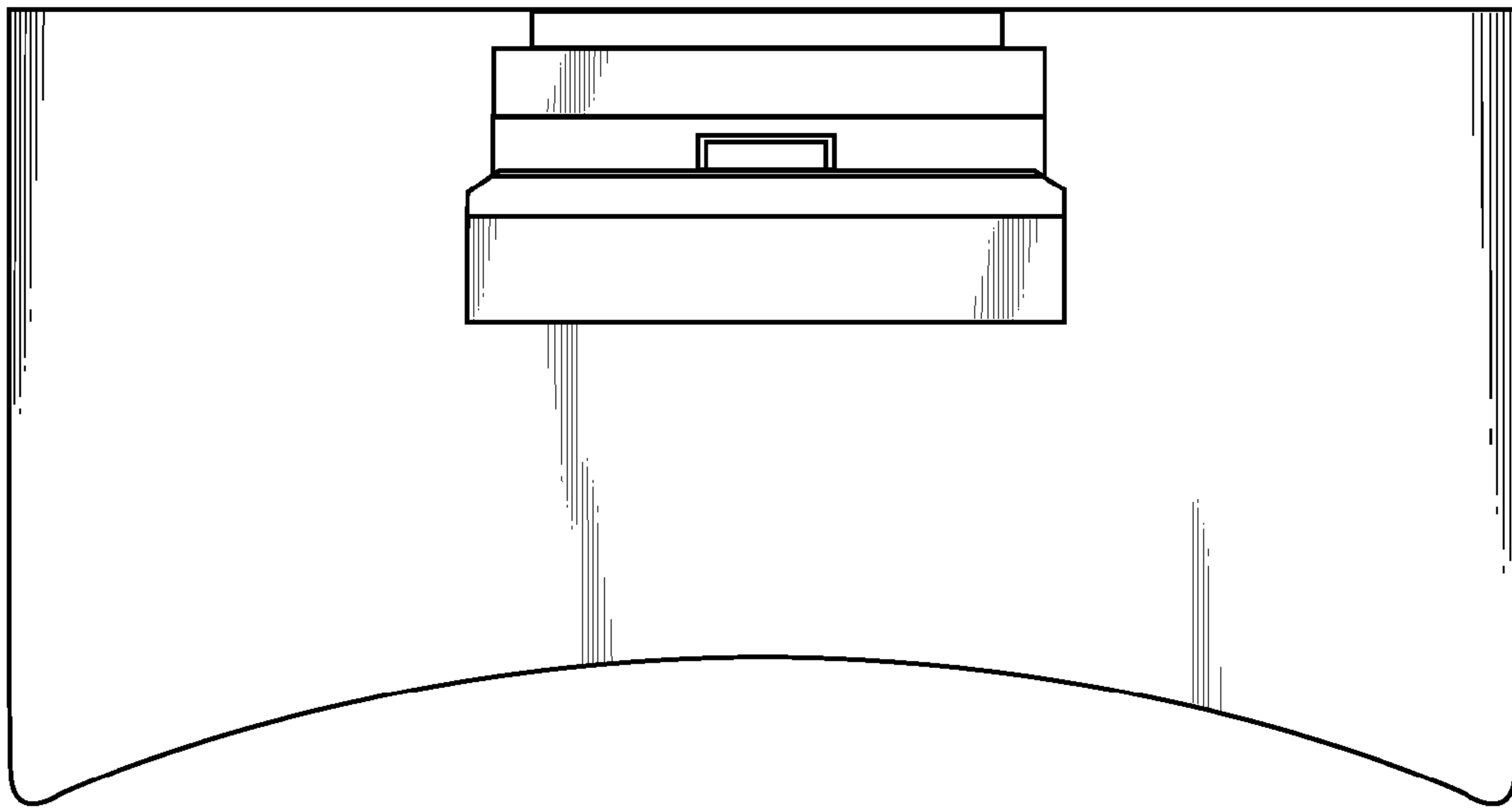
*Fig. 1*



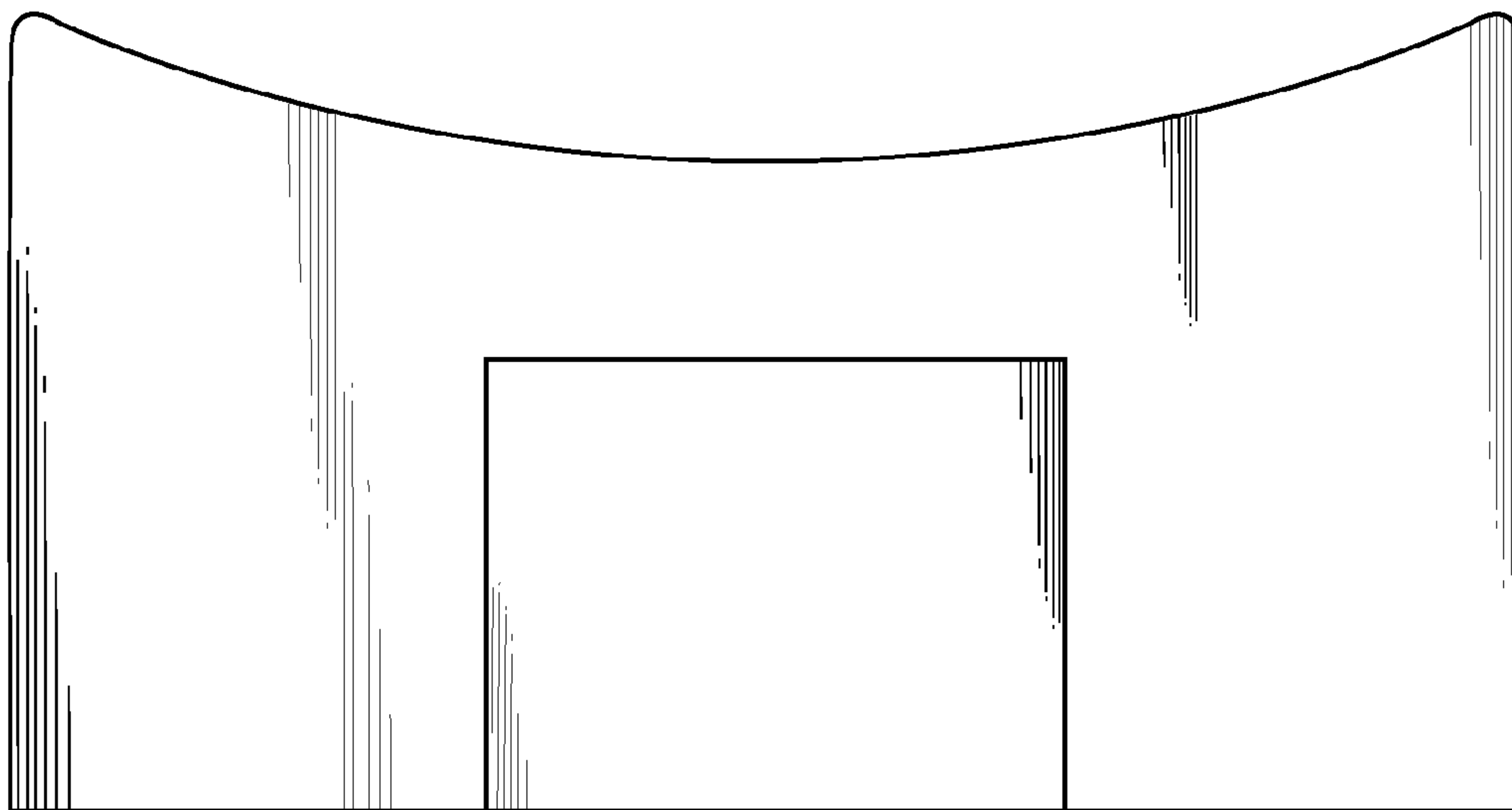
*Fig. 2*



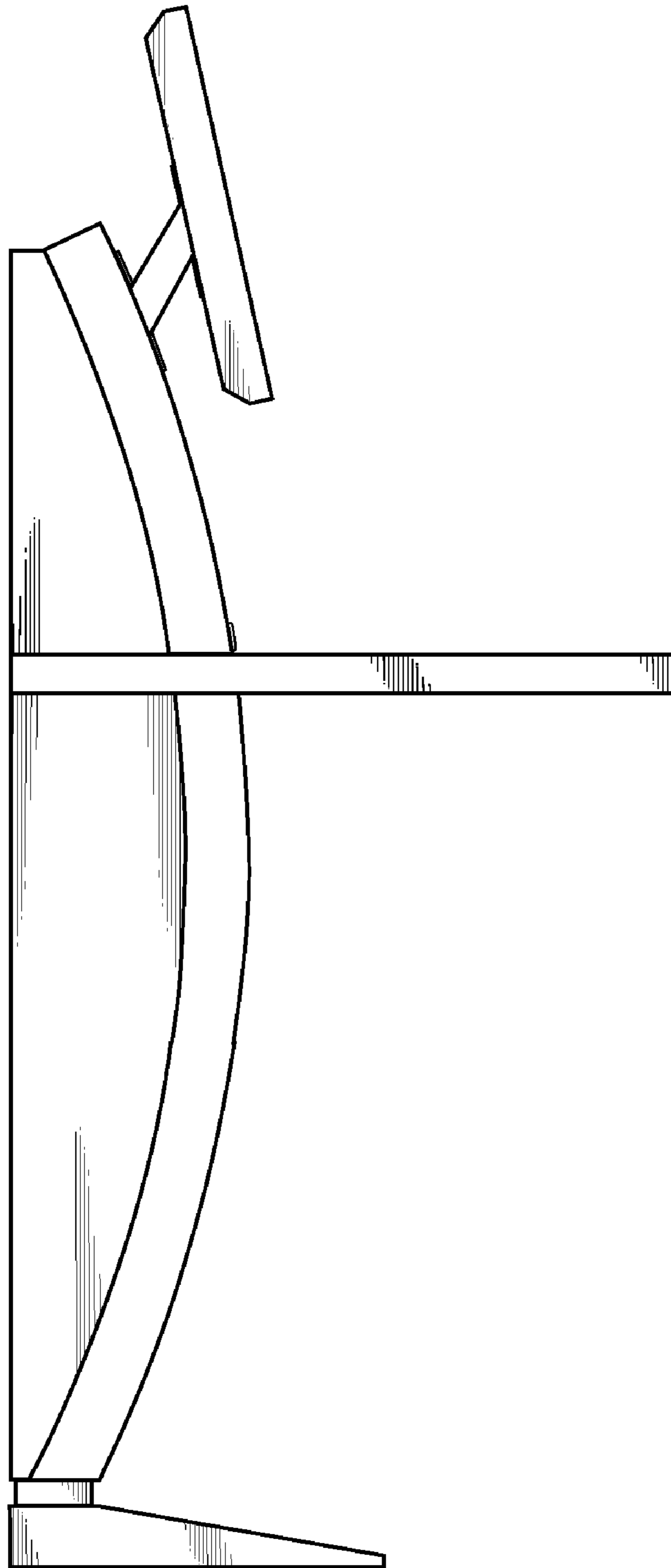
*Fig. 3*



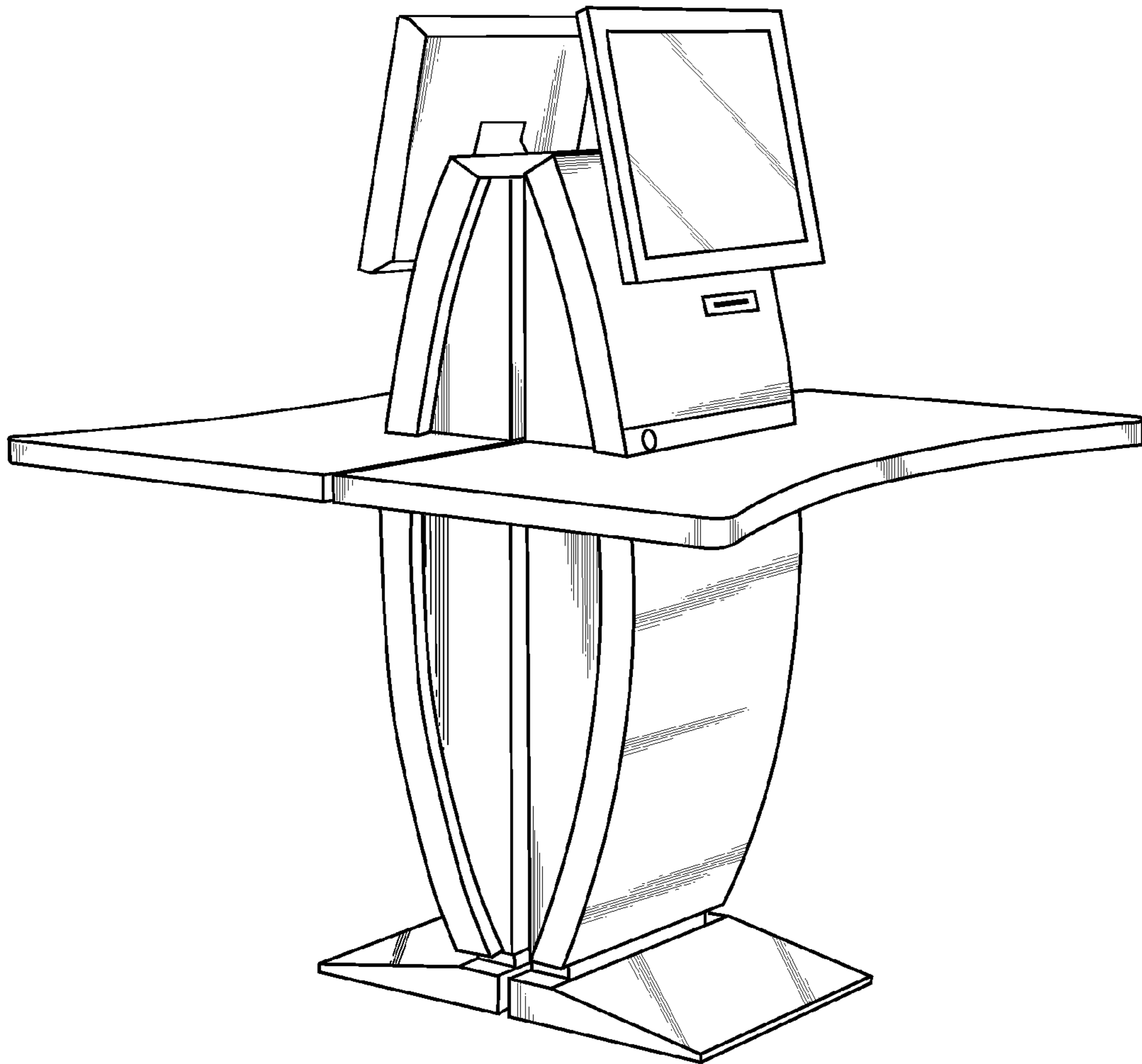
*Fig. 4*



*Fig. 5*

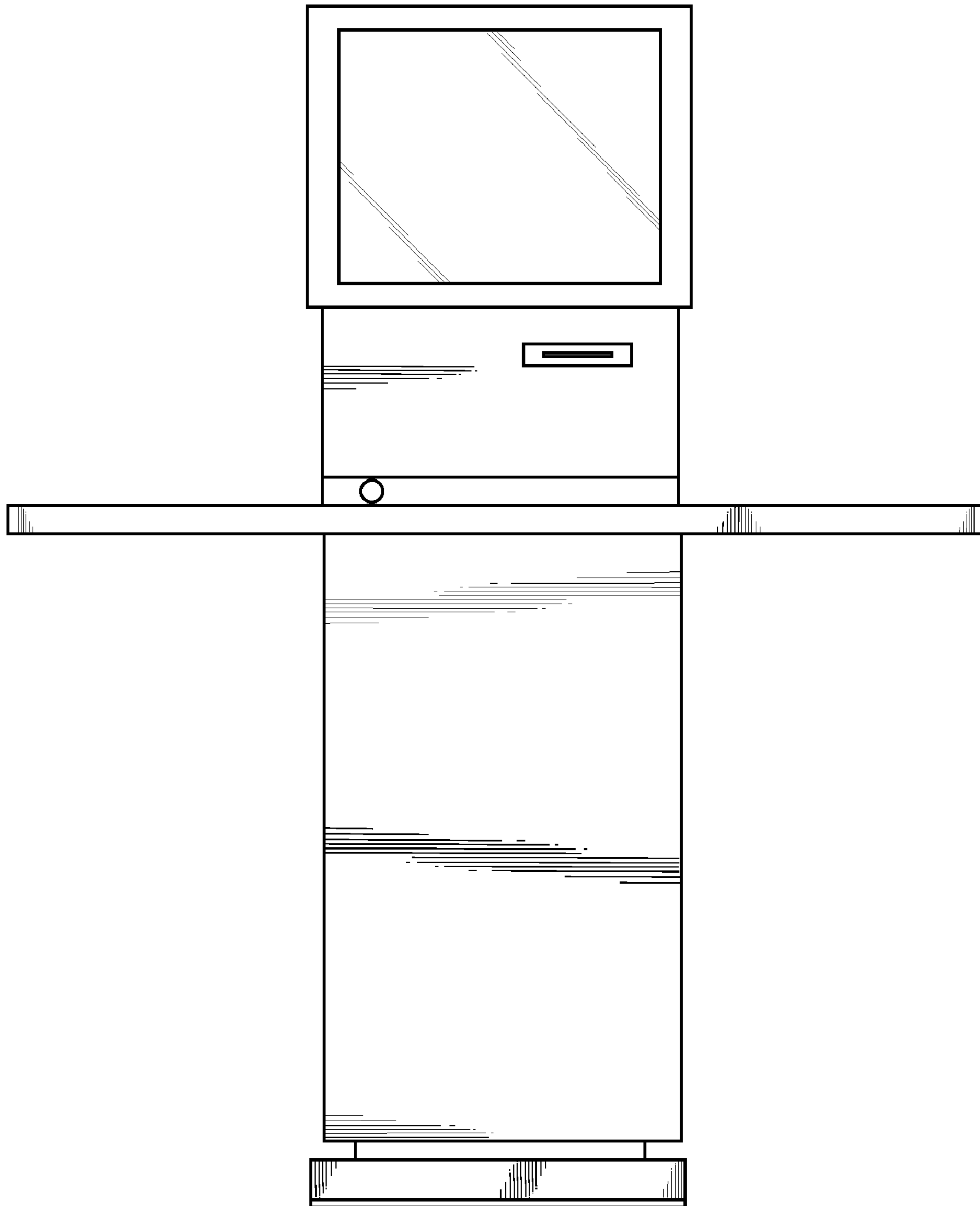


*Fig. 6*

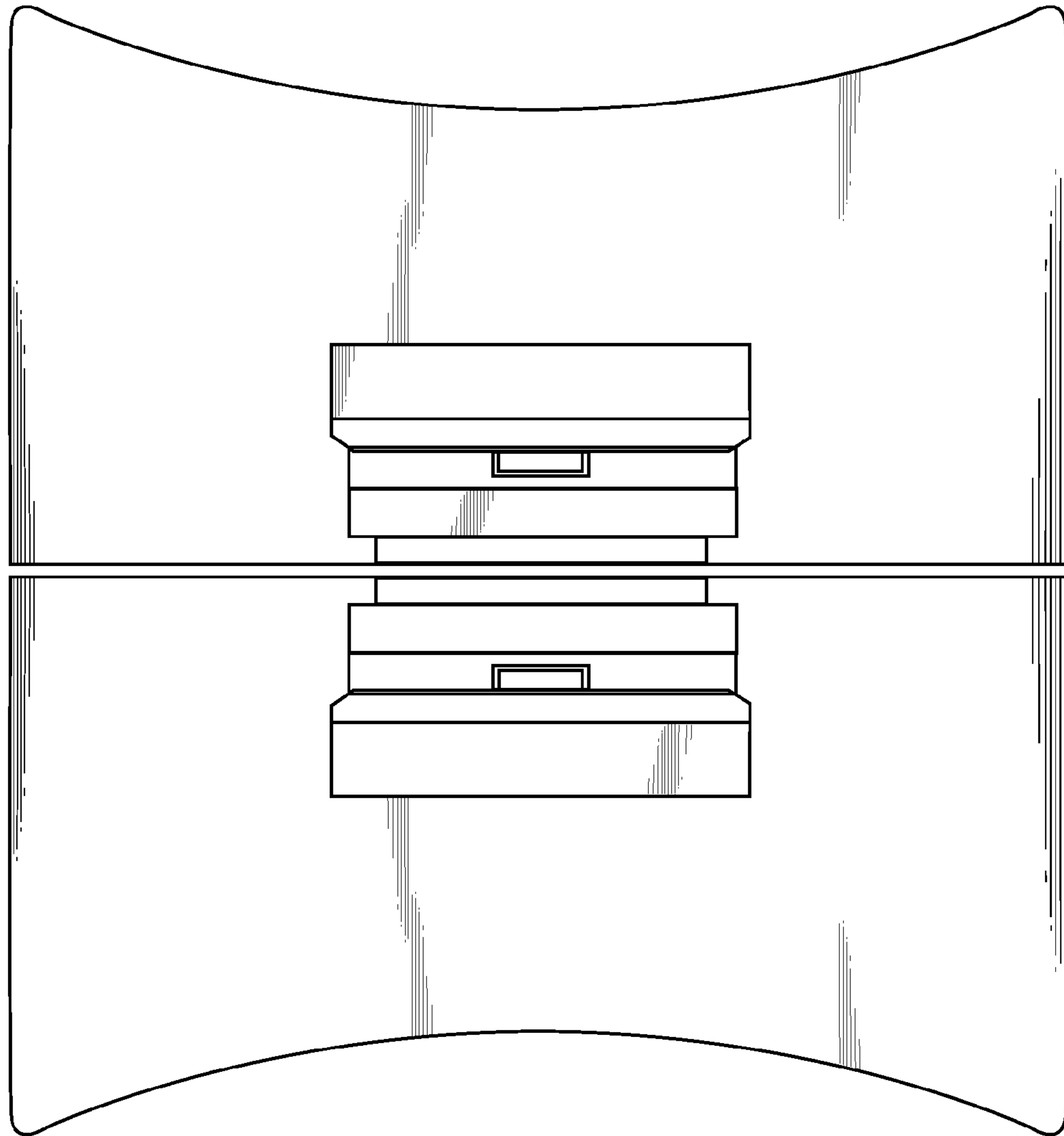


*Fig. 7*

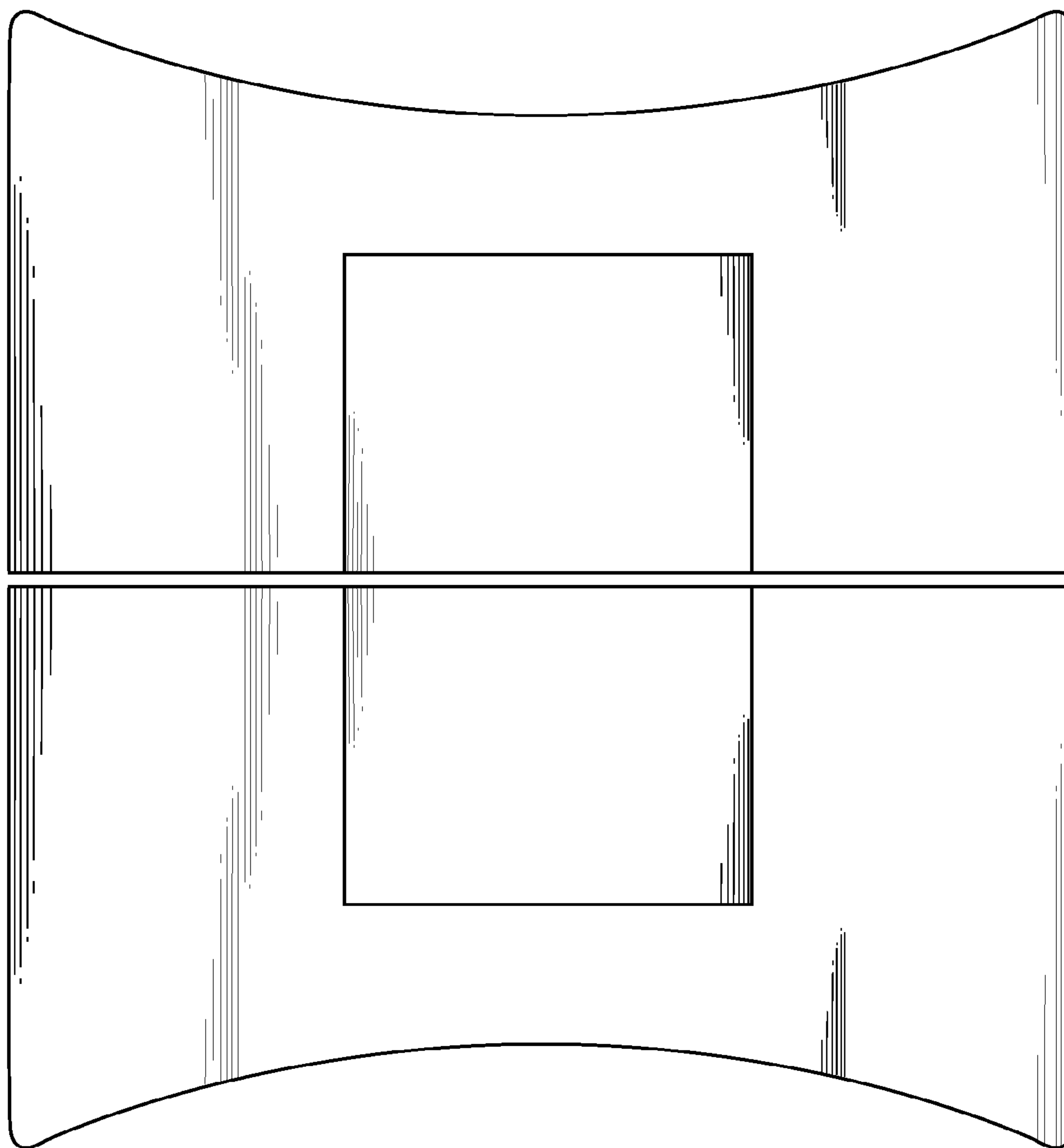




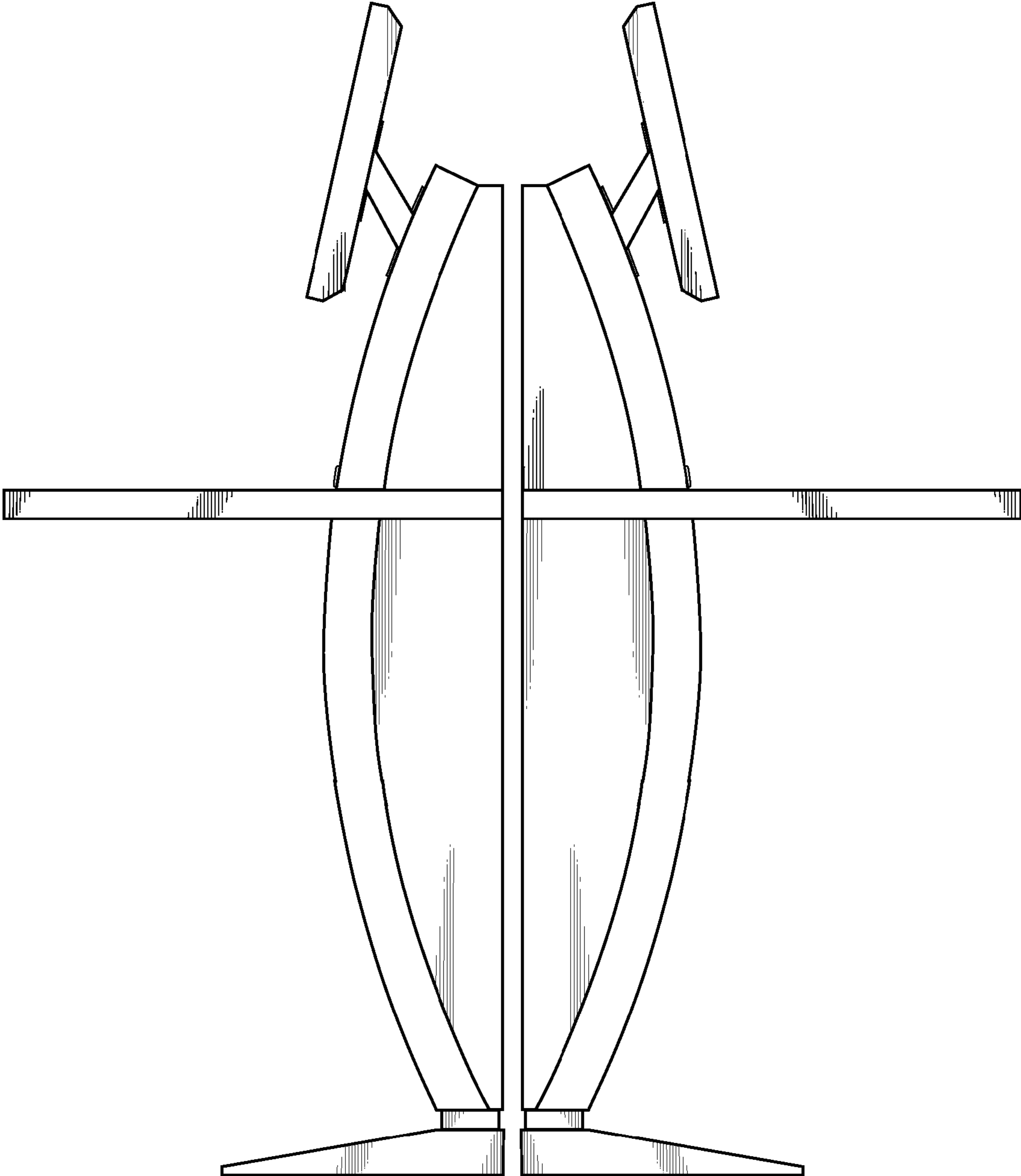
*Fig. 8*



*Fig. 9*



*Fig. 10*



*Fig. 11*