

US00D609492S

(12) **United States Design Patent**  
**Starck**

(10) **Patent No.:** **US D609,492 S**

(45) **Date of Patent:** **\*\* Feb. 9, 2010**

(54) **FURNITURE**

(75) Inventor: **Philippe Starck**, Paris (FR)

(73) Assignee: **Cassina S.p.A.**, Meda (IT)

(\*\*) Term: **14 Years**

(21) Appl. No.: **29/311,194**

(22) Filed: **Jan. 13, 2009**

(51) **LOC (9) Cl.** ..... **06-01**

(52) **U.S. Cl.** ..... **D6/381**

(58) **Field of Classification Search** ..... D6/334,  
D6/349, 355, 364, 370, 374, 378, 381, 382,  
D6/383, 491, 495, 500-503; 297/68, 232,  
297/233, 353, 445.1, 448.1, 448.2, DIG. 7;  
5/12.1, 12.2

See application file for complete search history.

(56) **References Cited**

**U.S. PATENT DOCUMENTS**

D192,913 S \* 5/1962 Wilson ..... D6/336  
D241,485 S \* 9/1976 Blodee ..... D6/336  
D251,460 S \* 4/1979 Albert ..... D6/336

\* cited by examiner

*Primary Examiner*—Sandra Snapp

(74) *Attorney, Agent, or Firm*—Nixon & Vanderhye P.C.

(57) **CLAIM**

The ornamental design for furniture, as shown and described.

**DESCRIPTION**

FIG. 1 is a front elevational view of furniture (first embodiment);

FIG. 2 is a rear elevational view thereof;

FIG. 3 is a right elevational view thereof;

FIG. 4 is a left elevational view thereof;

FIG. 5 is a top plan view thereof;

FIG. 6 is a bottom plan view thereof;

FIG. 7 is a front, left perspective view thereof;

FIG. 8 is a front elevational view of furniture (second embodiment);

FIG. 9 is a rear elevational view thereof;

FIG. 10 is a right elevational view thereof;

FIG. 11 is a left elevational view thereof;

FIG. 12 is a top plan view thereof;

FIG. 13 is a bottom plan view thereof; and,

FIG. 14 is a left, front perspective view thereof.

The broken lines shown in the drawings are for illustrative purposes only and form no part of the claimed design.

**1 Claim, 7 Drawing Sheets**

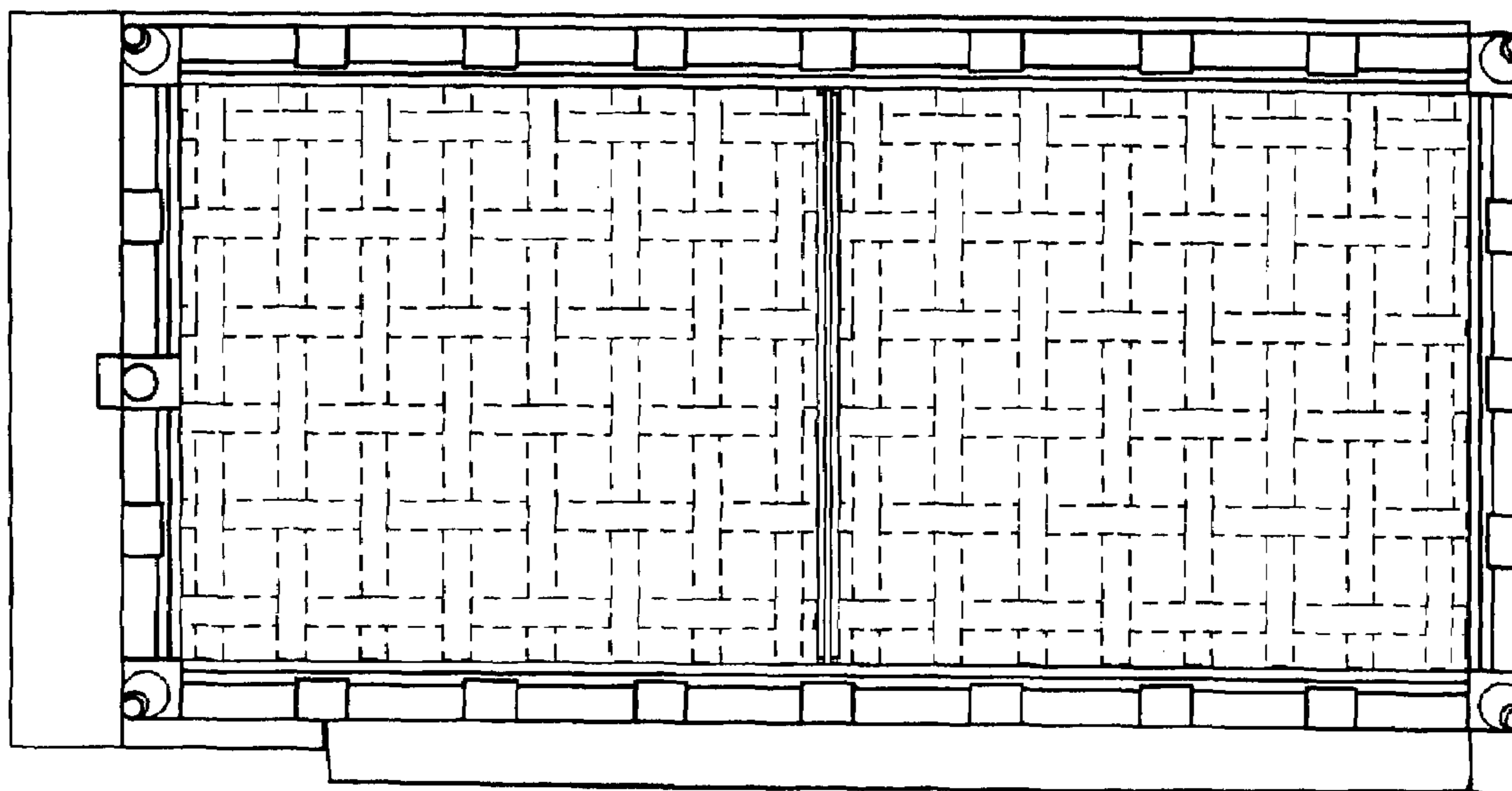

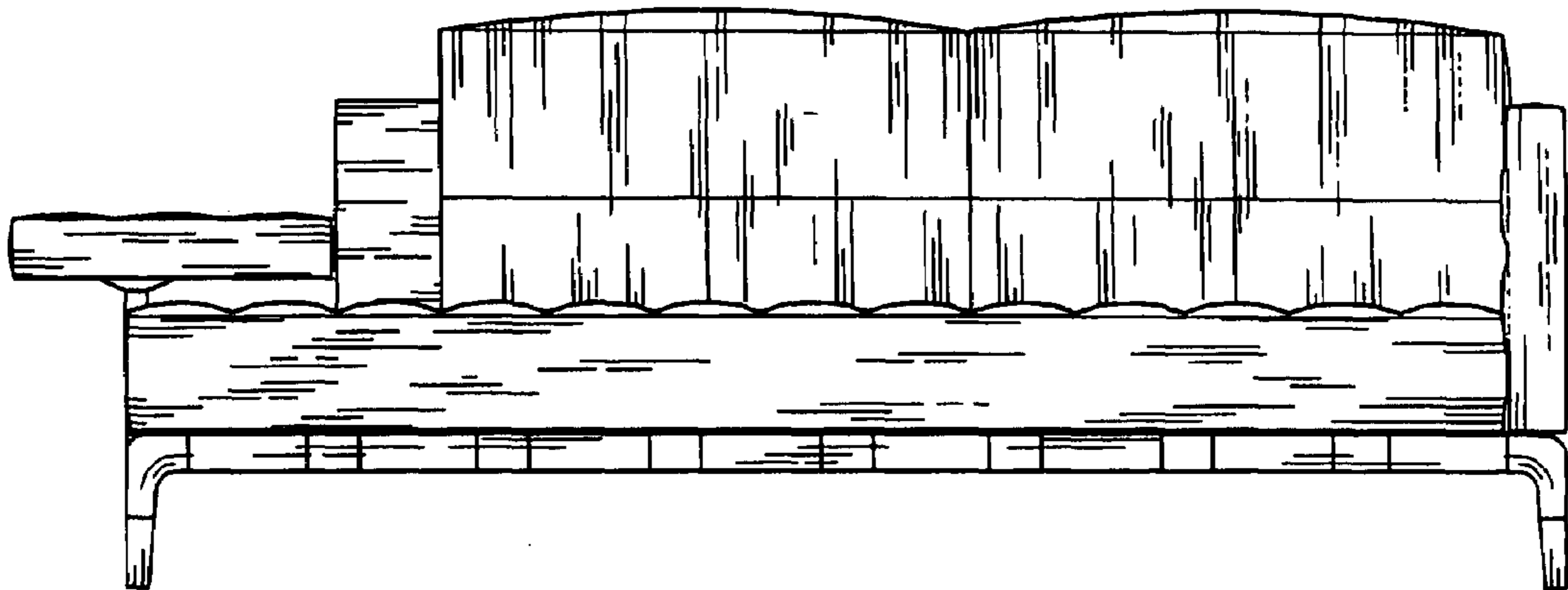

FIG. 1

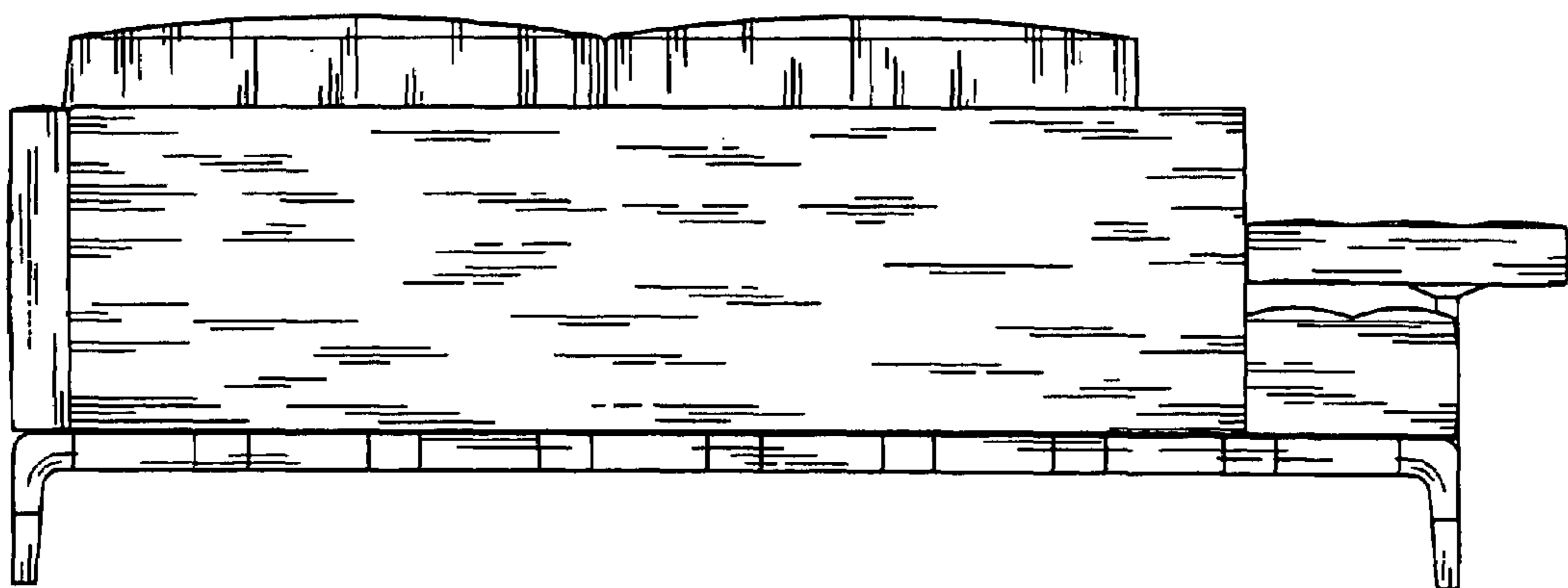

FIG. 2

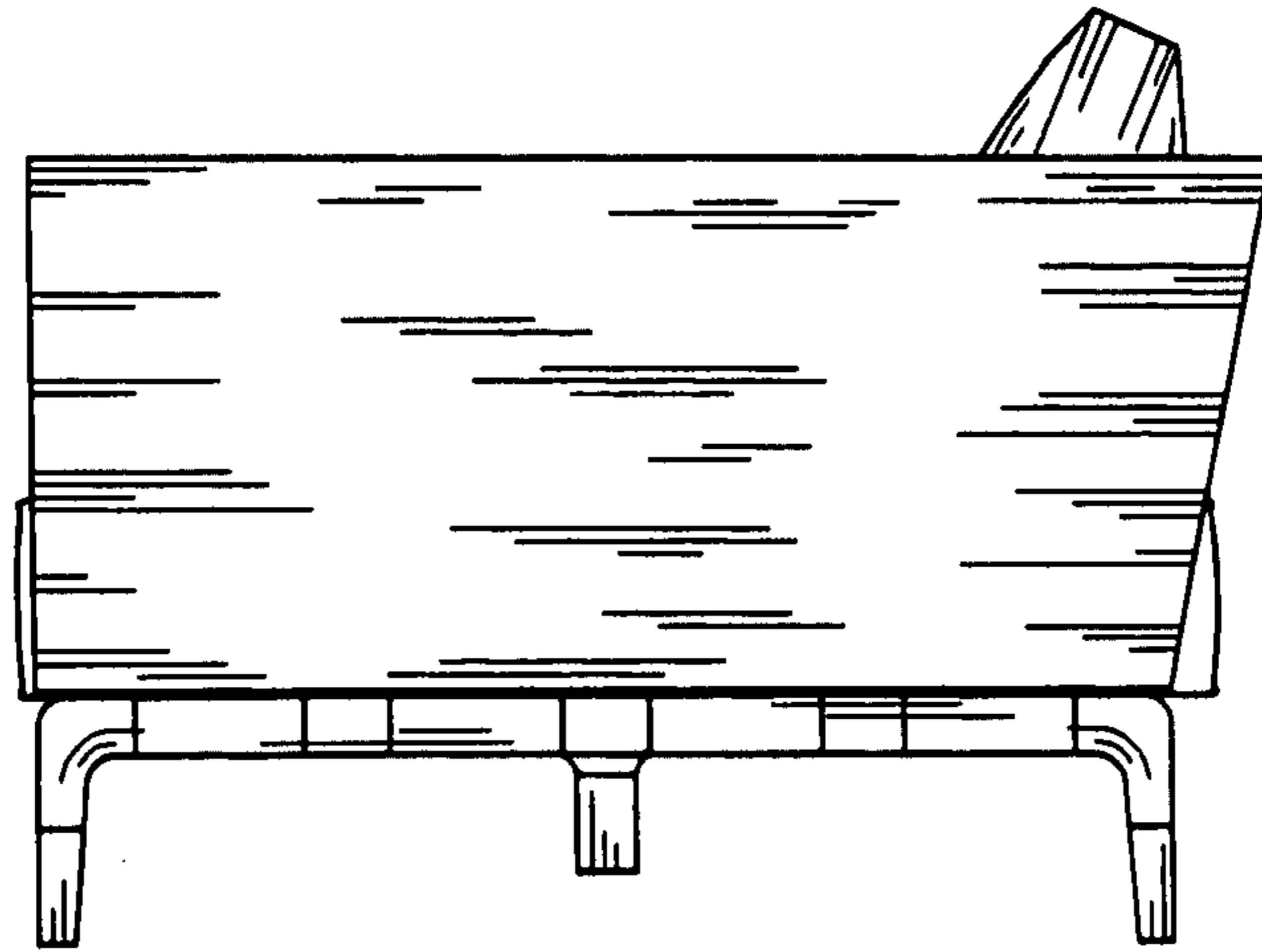

FIG. 3

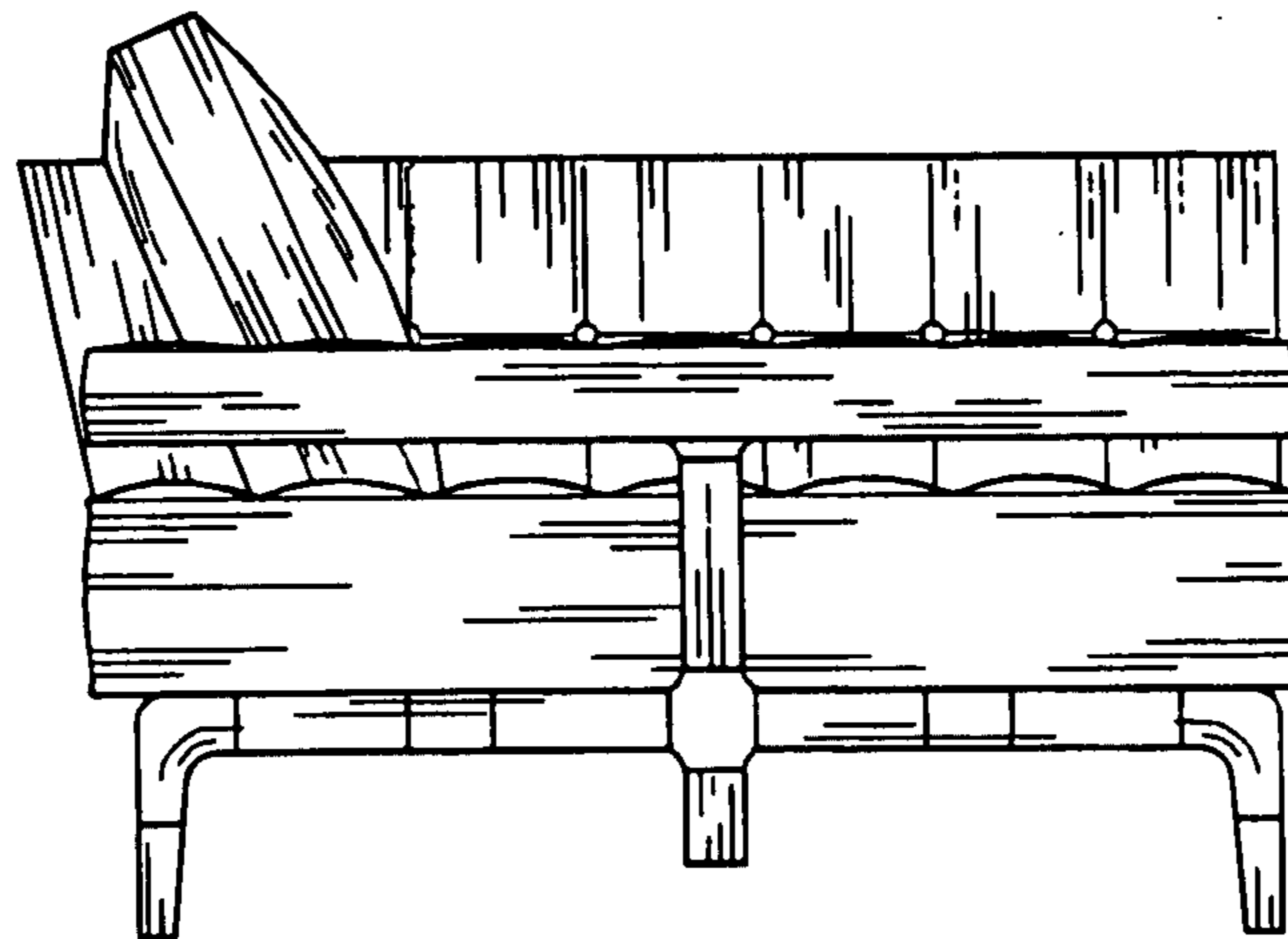

FIG. 4

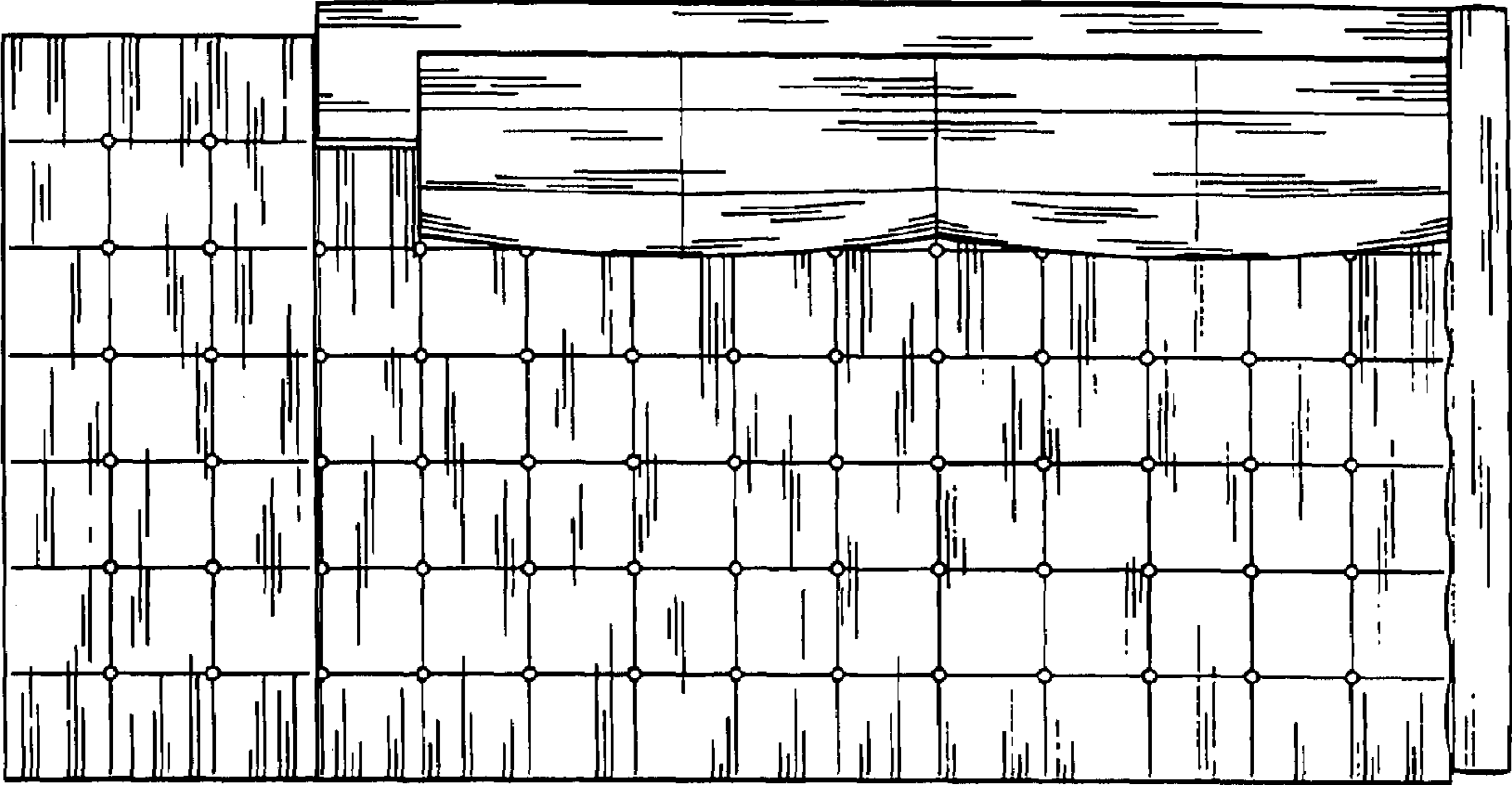

FIG. 5

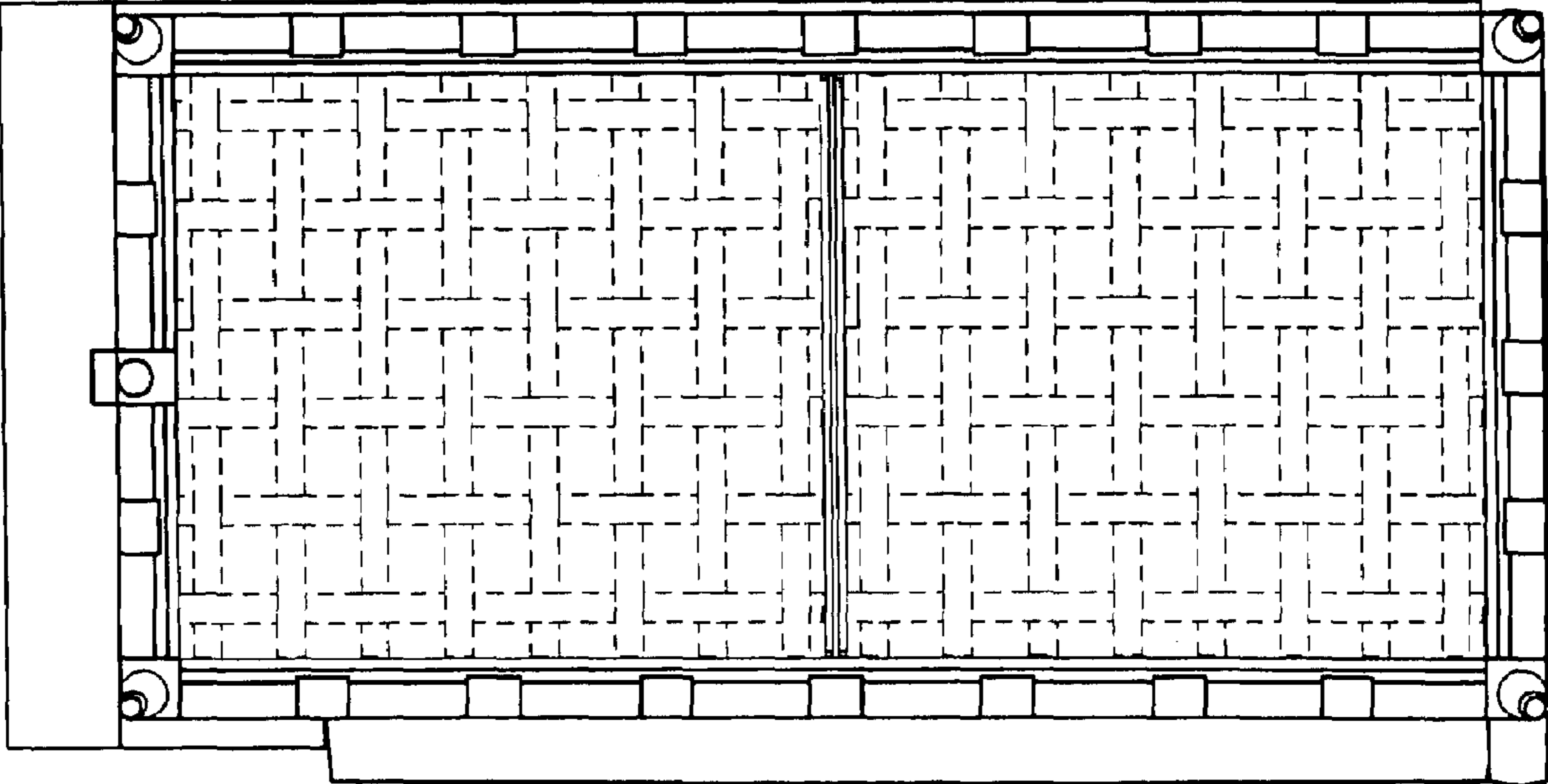

FIG. 6

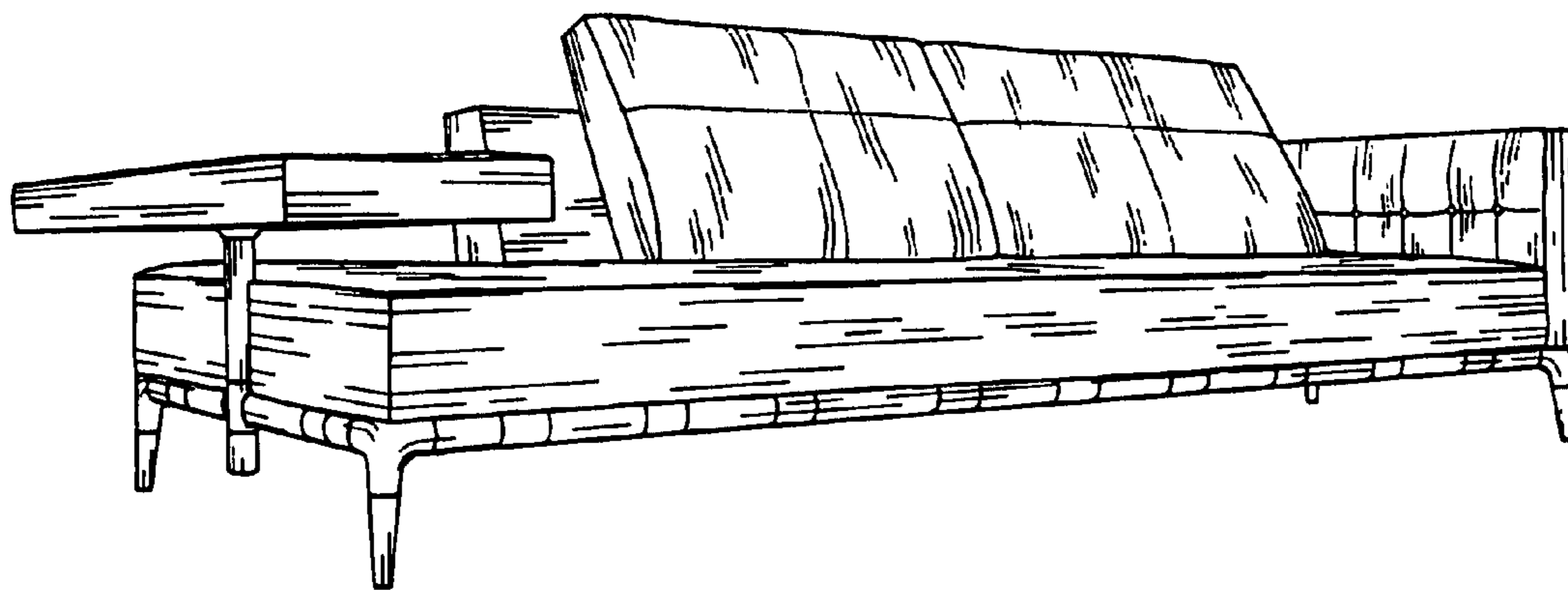

FIG. 7

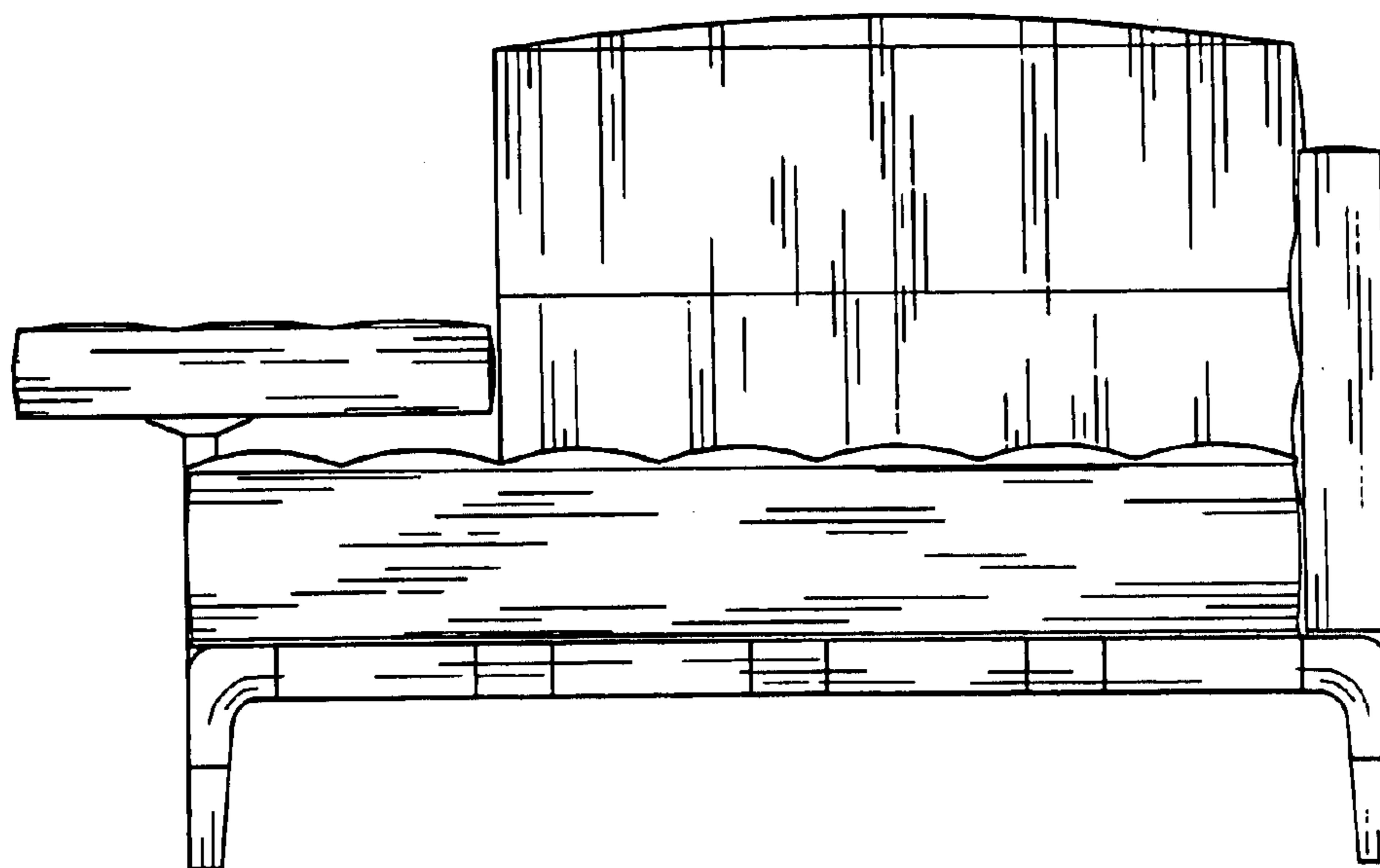

FIG. 8

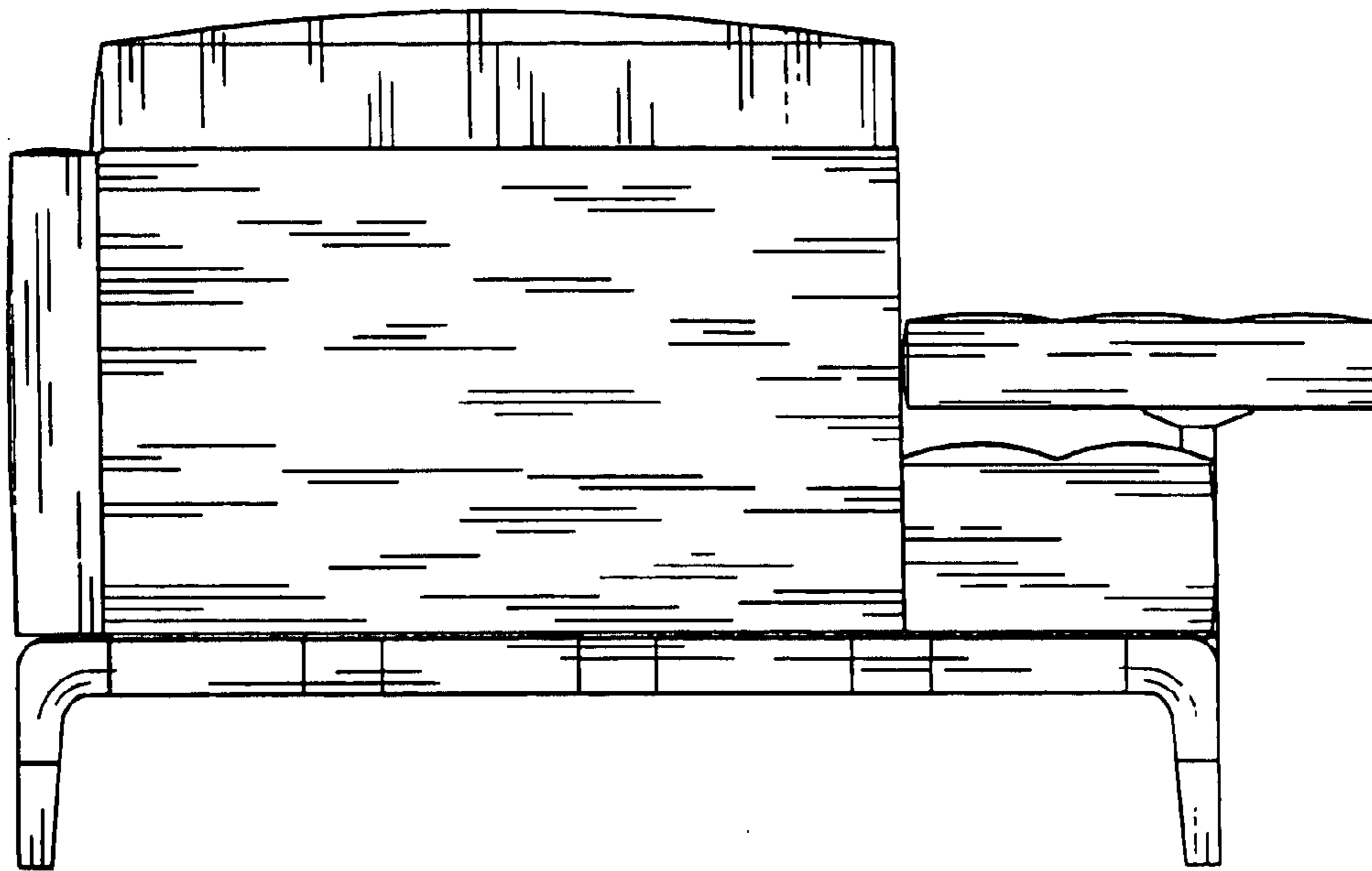

FIG. 9

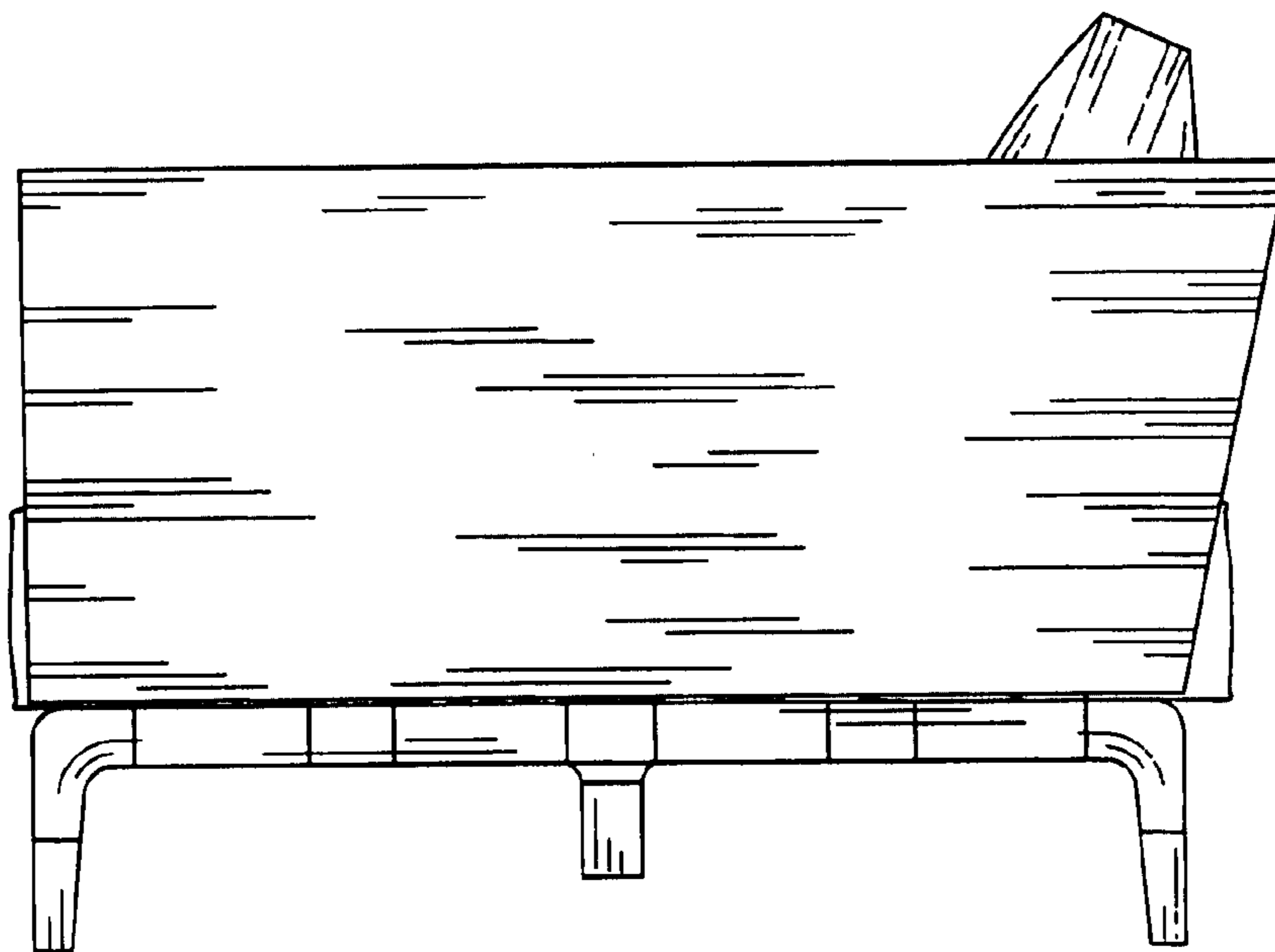

FIG. 10

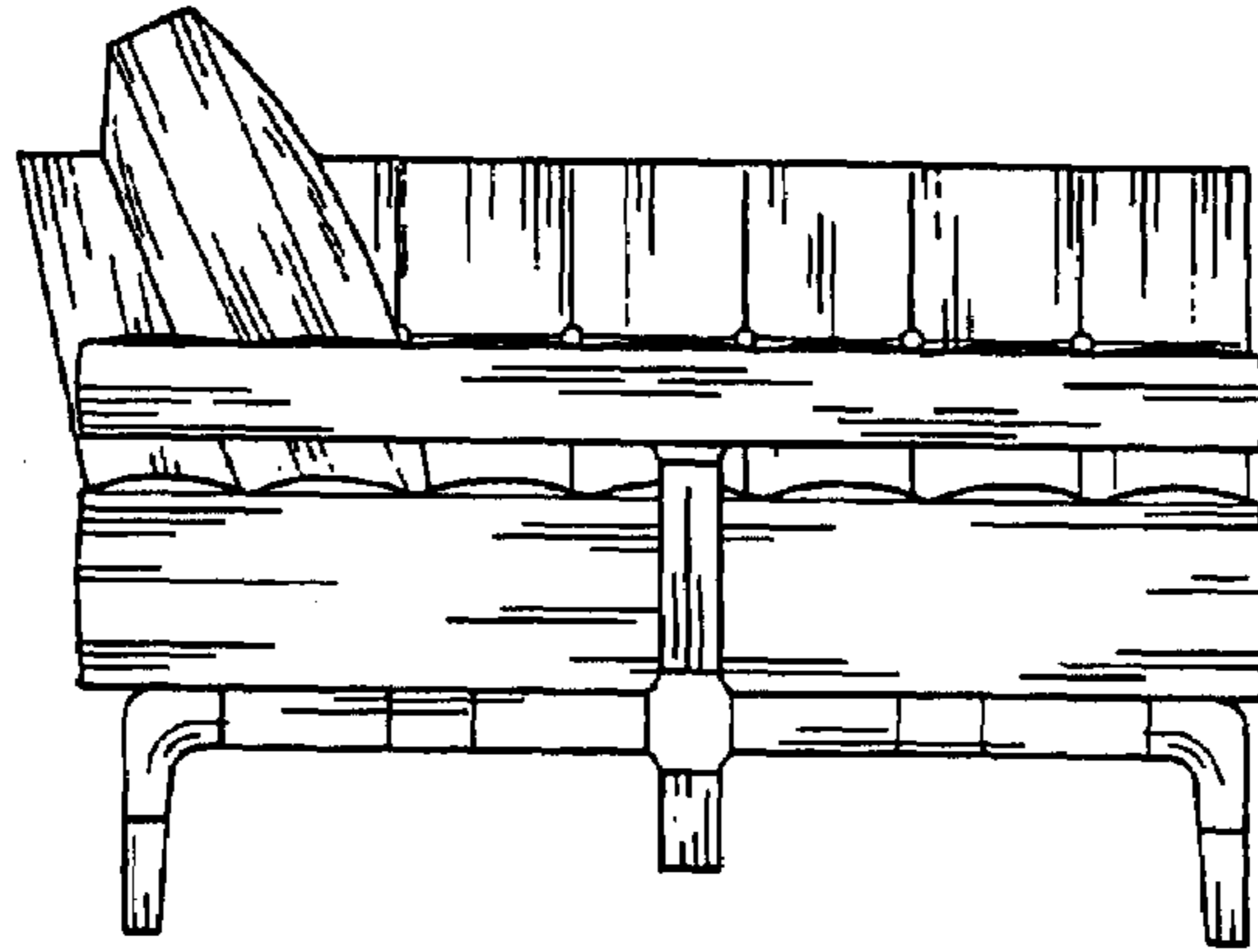

FIG. 11

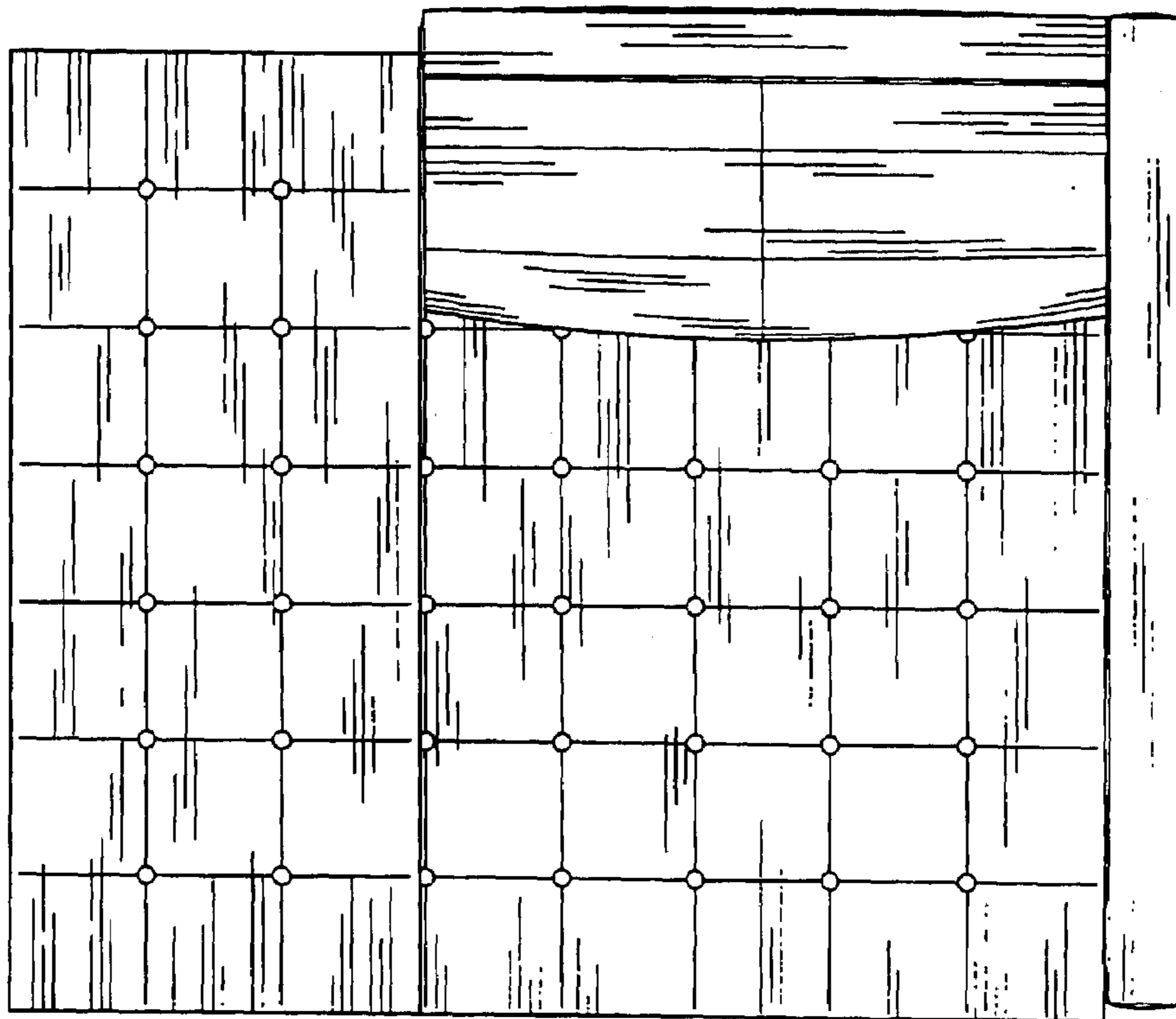

FIG. 12



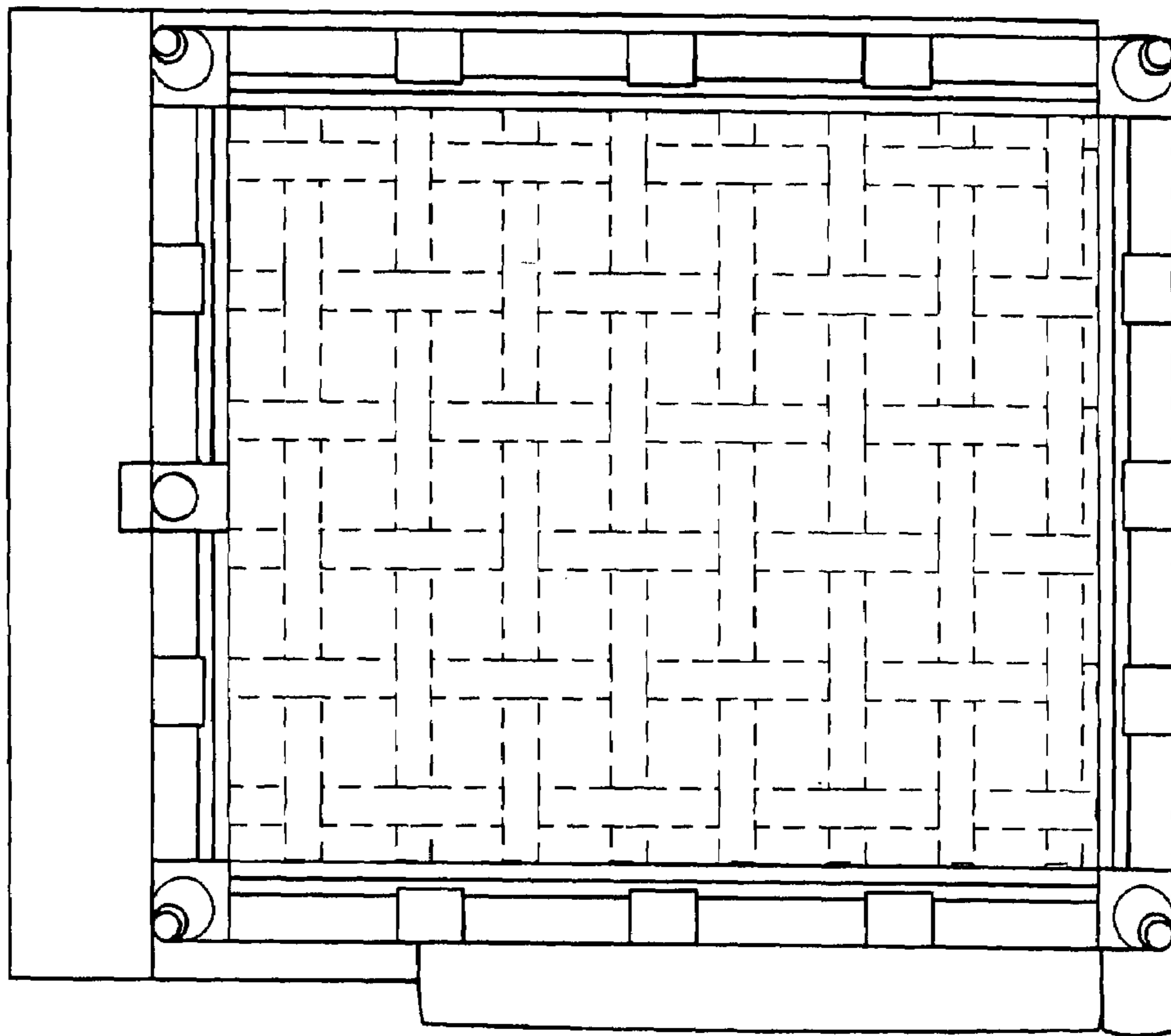

FIG. 13

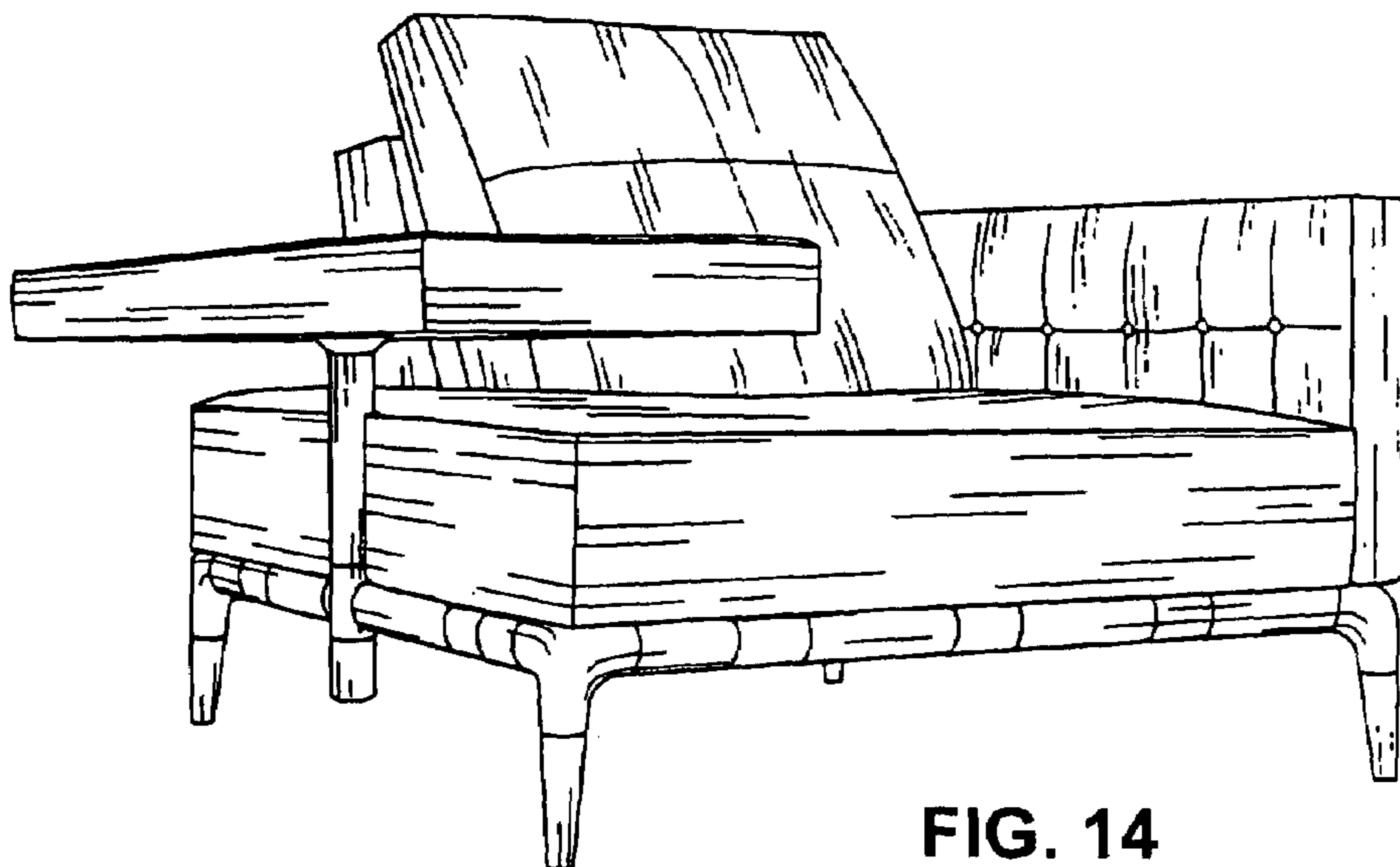

FIG. 14