



US00D609471S

(12) **United States Design Patent**
Rogers

(10) **Patent No.:** **US D609,471 S**

(45) **Date of Patent:** **** Feb. 9, 2010**

(54) **BEACH TOWEL**

(76) Inventor: **Michael T. Rogers**, 1778 Ala Moana,
Apt. 2717, Honolulu, HI (US) 96815

(**) Term: **14 Years**

(21) Appl. No.: **29/262,979**

(22) Filed: **Jul. 14, 2006**

(51) **LOC (9) Cl.** **03-01**

(52) **U.S. Cl.** **D3/274**

(58) **Field of Classification Search** D3/215,
D3/273, 276, 285, 287, 274, 289; 383/3,
383/4; 5/417, 419; 224/153

See application file for complete search history.

(56) **References Cited**

U.S. PATENT DOCUMENTS

5,346,308	A *	9/1994	Buhot et al.	383/4
5,467,487	A	11/1995	Sicard		
5,481,767	A *	1/1996	Lewis	5/417
5,618,110	A *	4/1997	Sullivan	383/4
5,785,219	A *	7/1998	Kraft	224/576
5,819,343	A	10/1998	Zampirri, Jr. et al.		
D409,874	S	5/1999	Amick et al.		
6,192,536	B1	2/2001	Connors		
6,230,950	B1 *	5/2001	Heetman	224/575
D482,224	S	11/2003	DeCet		
D493,657	S	8/2004	Farago et al.		
7,017,206	B1 *	3/2006	Kedineoglu	5/417

2004/0188482	A1 *	9/2004	Wilson et al.	224/576
2006/0037139	A1 *	2/2006	Akkad	5/419

OTHER PUBLICATIONS

http://ecx.images-amazon.com/images/I/51NC9NZKF-L._SS384.jpg Oct. 28, 2008.*

* cited by examiner

Primary Examiner—T. Chase Nelson

Assistant Examiner—Kathleen M Sims

(74) *Attorney, Agent, or Firm*—Lawrence J. Gibney, Jr.

(57) **CLAIM**

The ornamental design for a beach towel, as shown and described.

DESCRIPTION

FIG. 1 is a front view of the beach towel showing my new design;

FIG. 2 is a back view thereof;

FIG. 3 is a left side view thereof;

FIG. 4 is a right side view thereof;

FIG. 5 is a top view thereof;

FIG. 6 is a bottom view thereof; and,

FIG. 7 is an isometric view thereof.

The portions of the beach towel in broken lines form no part of the claimed design.

1 Claim, 5 Drawing Sheets

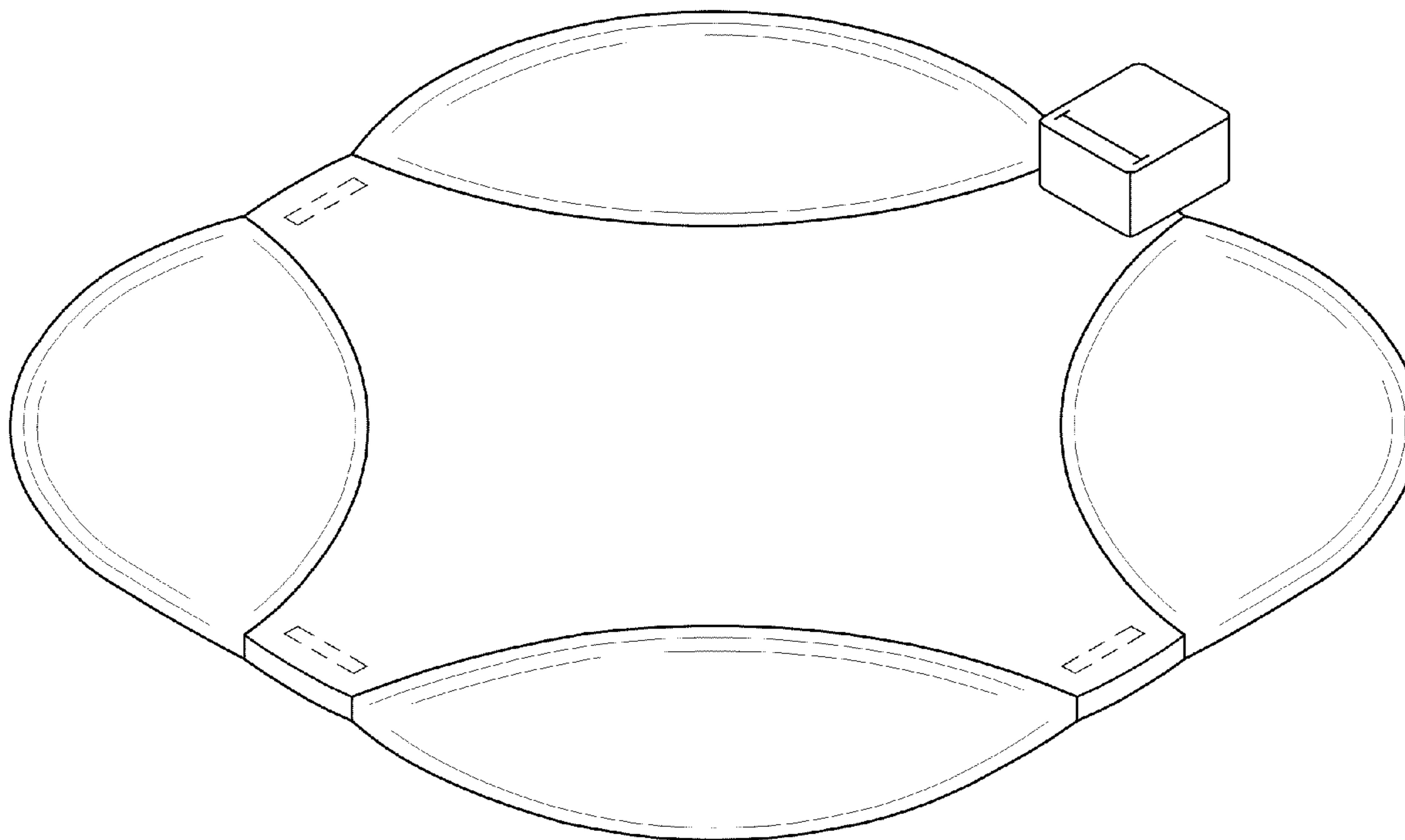

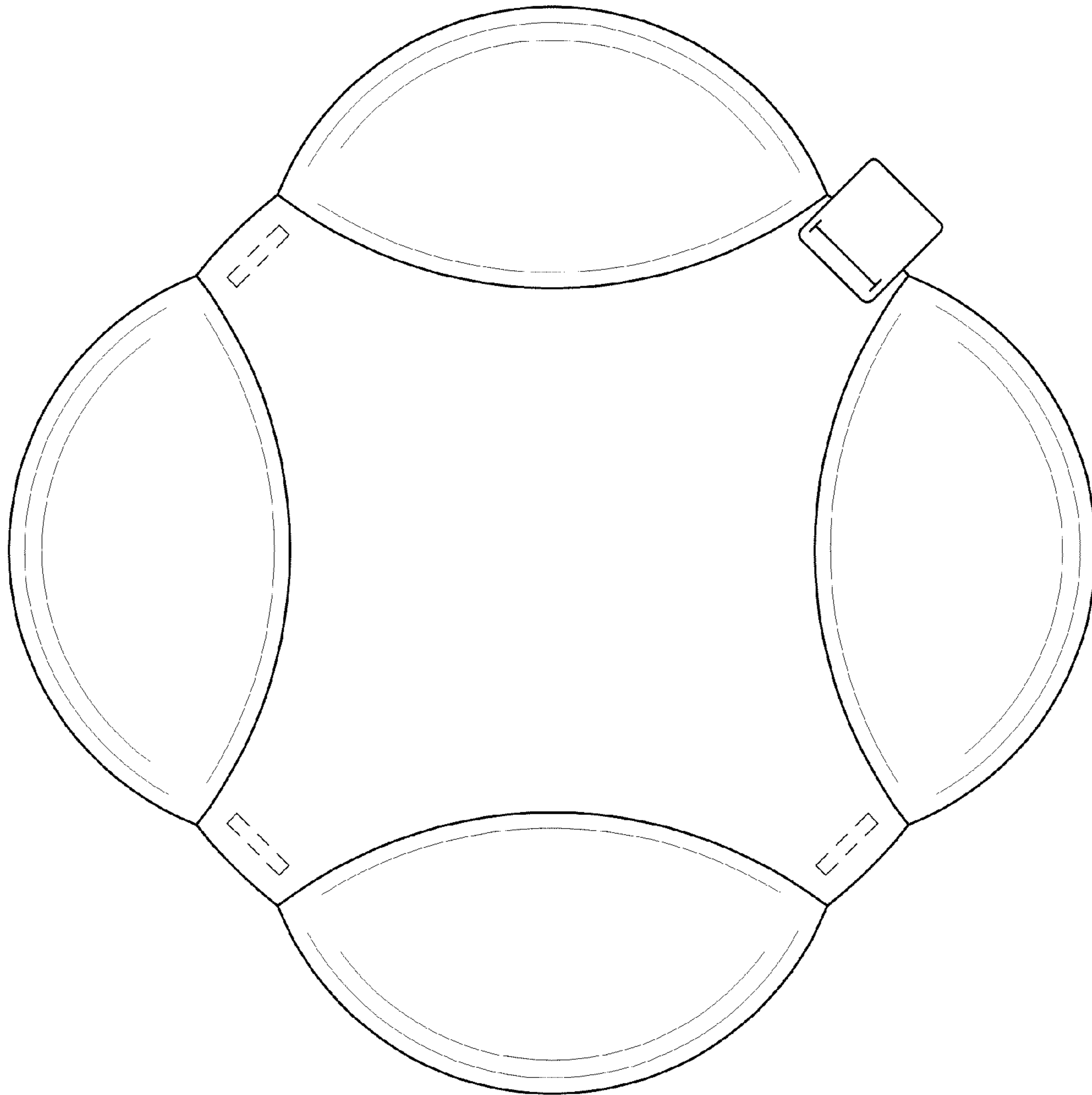

FIG.1

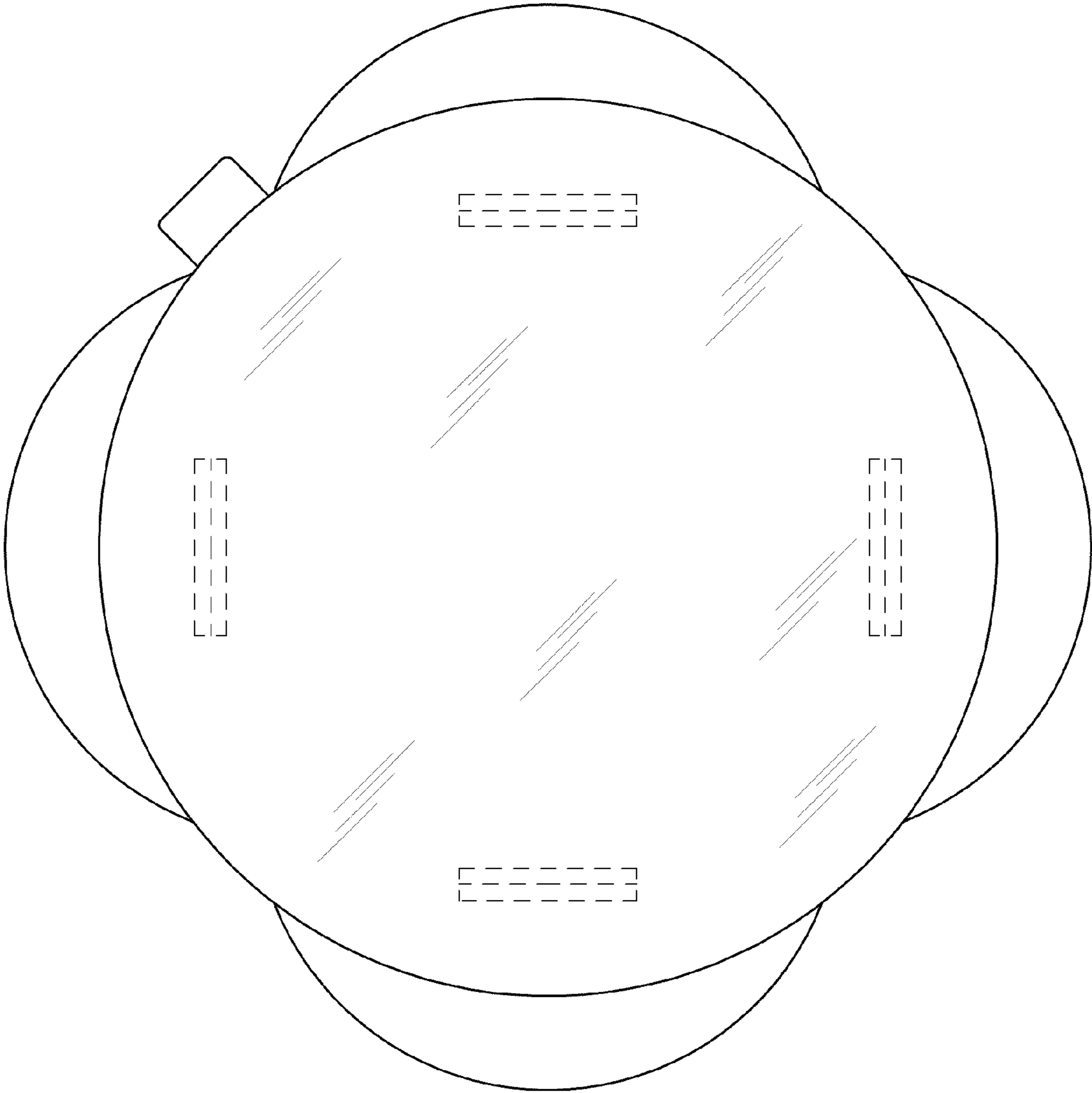

FIG.2

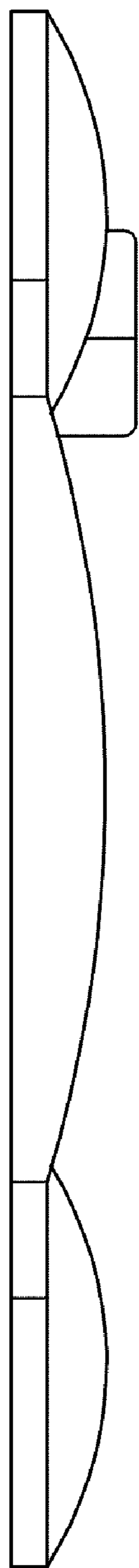

FIG.3

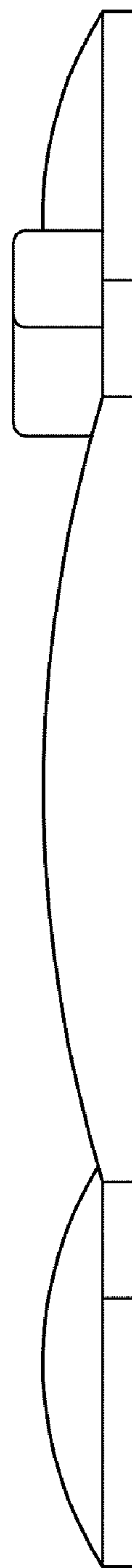

FIG.4

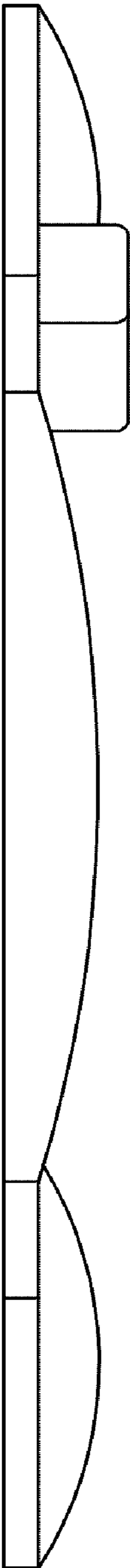

FIG. 5

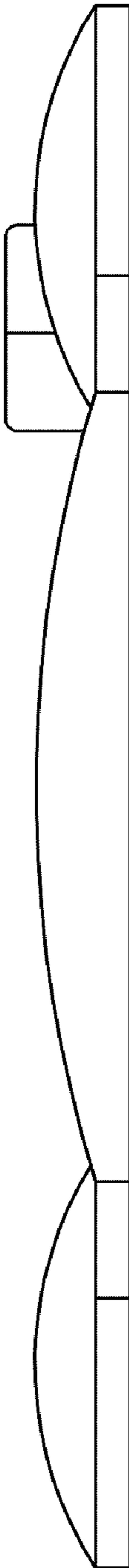

FIG. 6

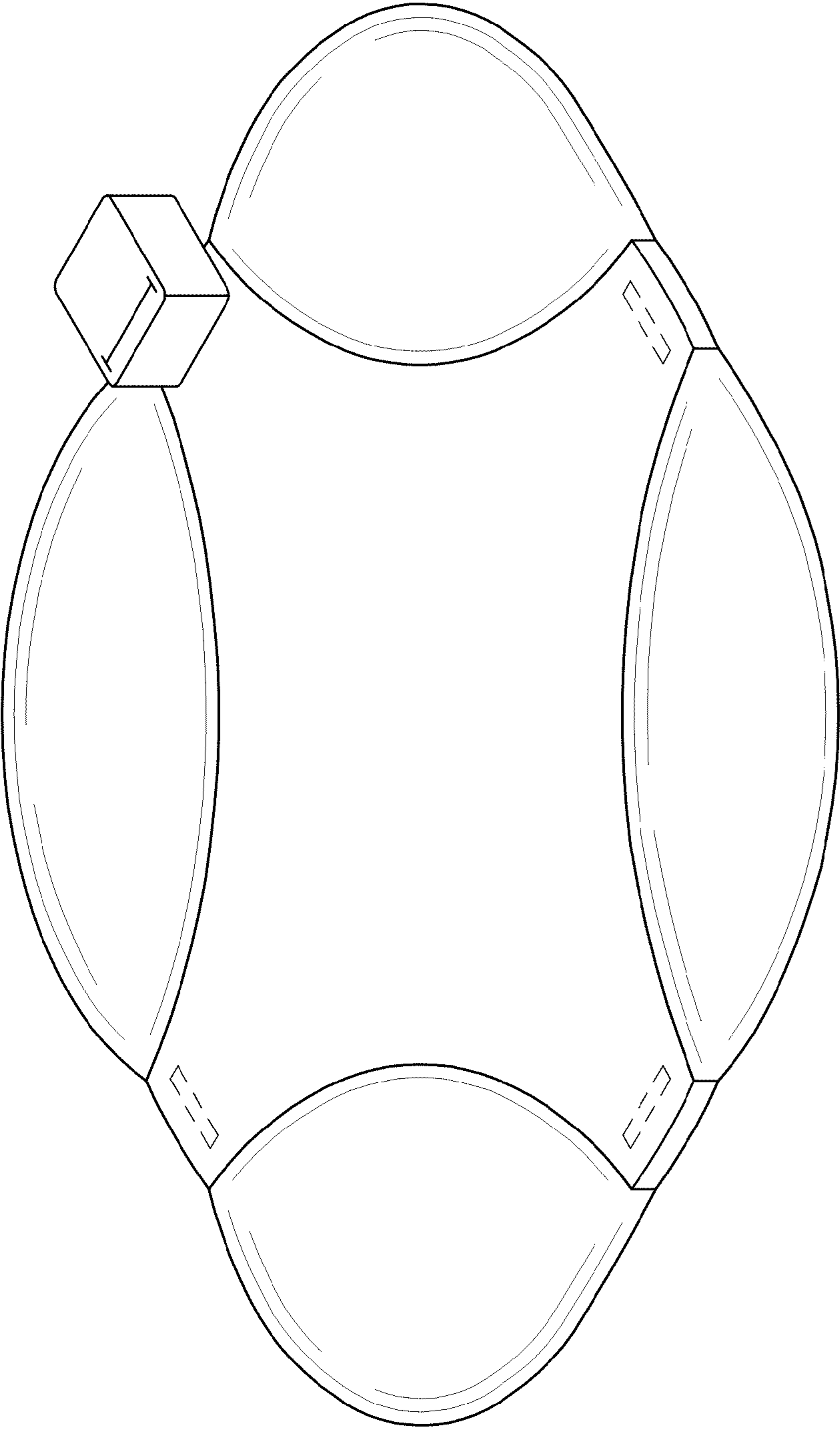

FIG.7