



US00D609463S

(12) **United States Design Patent**  
**Bullen**

(10) **Patent No.:** **US D609,463 S**

(45) **Date of Patent:** **\*\* Feb. 9, 2010**

(54) **CASE FOR A CELL PHONE**

(75) Inventor: **Melvin James Bullen**, Los Gatos, CA  
(US)

(73) Assignee: **Solar Components LLC**, Campbell, CA  
(US)

(\*\*) Term: **14 Years**

(21) Appl. No.: **29/334,734**

(22) Filed: **Mar. 31, 2009**

(51) **LOC (9) Cl.** ..... **03-01**

(52) **U.S. Cl.** ..... **D3/218**

(58) **Field of Classification Search** ..... D3/218,  
D3/219, 215, 201, 269, 272; 224/240, 245,  
224/929-930, 667, 587, 683; 379/433.11,  
379/437, 440, 446-447, 449-455; D14/250-253,  
D14/138, 345, 432, 439-440; 455/575.1,  
455/575.6, 575.8, 575.9

See application file for complete search history.

(56) **References Cited**

**U.S. PATENT DOCUMENTS**

D556,681 S \* 12/2007 Kim ..... D3/218

D575,056 S \* 8/2008 Tan ..... D3/218  
D587,896 S \* 3/2009 Aipa ..... D3/201  
D597,089 S \* 7/2009 Khan et al. .... D14/250

\* cited by examiner

*Primary Examiner*—Catherine R Oliver

(74) *Attorney, Agent, or Firm*—Haynes & Boone LLP

(57) **CLAIM**

The ornamental design for the case for a cell phone, as shown and described.

**DESCRIPTION**

FIG. 1 is a front and right side perspective view of the case for a cell phone showing my new design;

FIG. 2 is a left side view thereof;

FIG. 3 is a front view thereof;

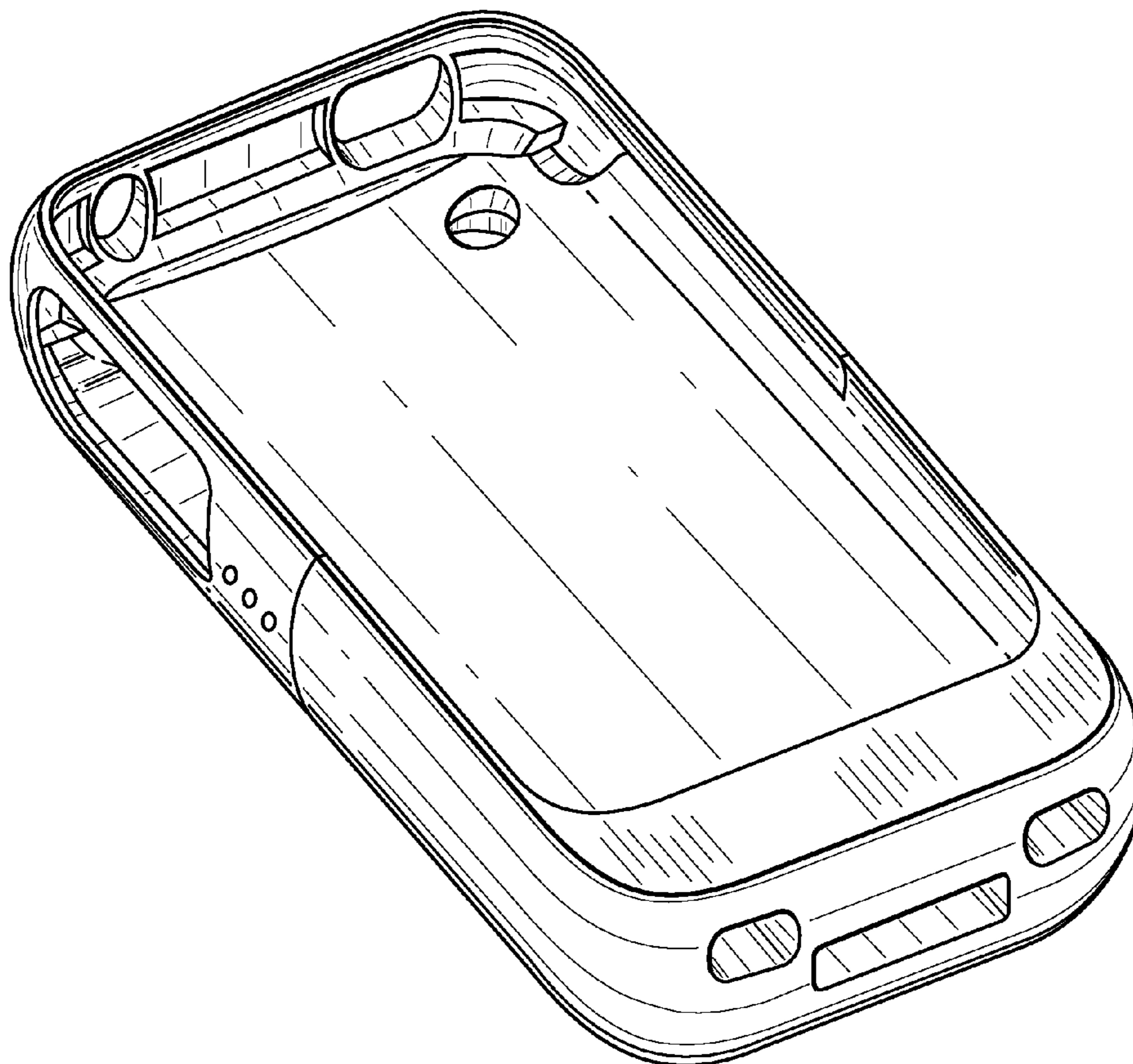
FIG. 4 is a rear view thereof;

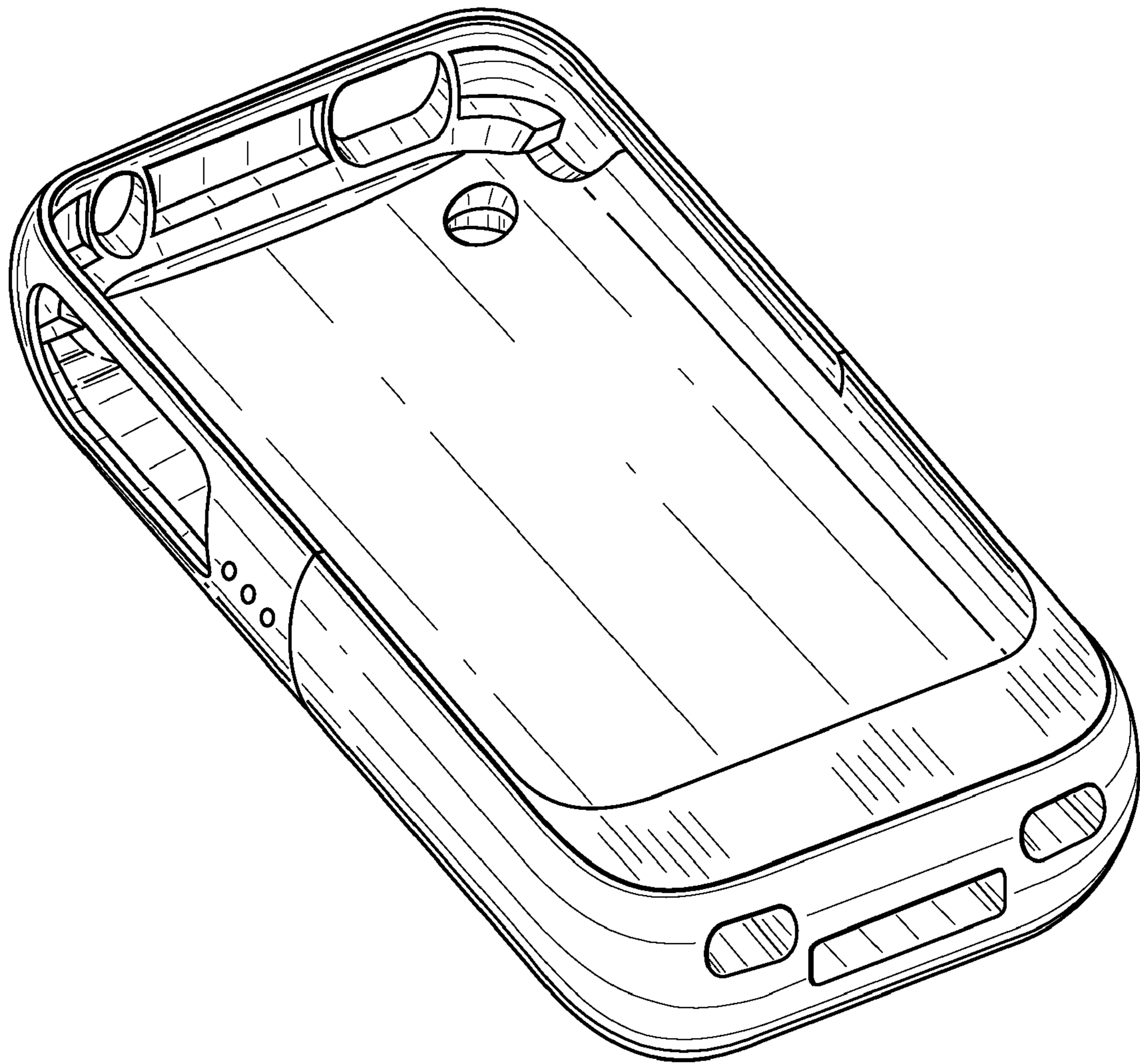
FIG. 5 is a top view thereof;

FIG. 6 is a bottom view thereof; and,

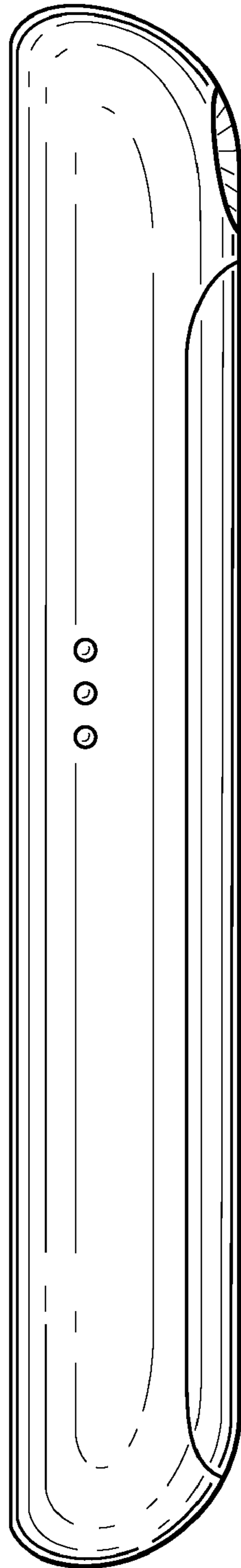
FIG. 7 is a perspective view of the case for a cell phone shown separated to show the shape and interrelationship of the two components of the design.

**1 Claim, 6 Drawing Sheets**

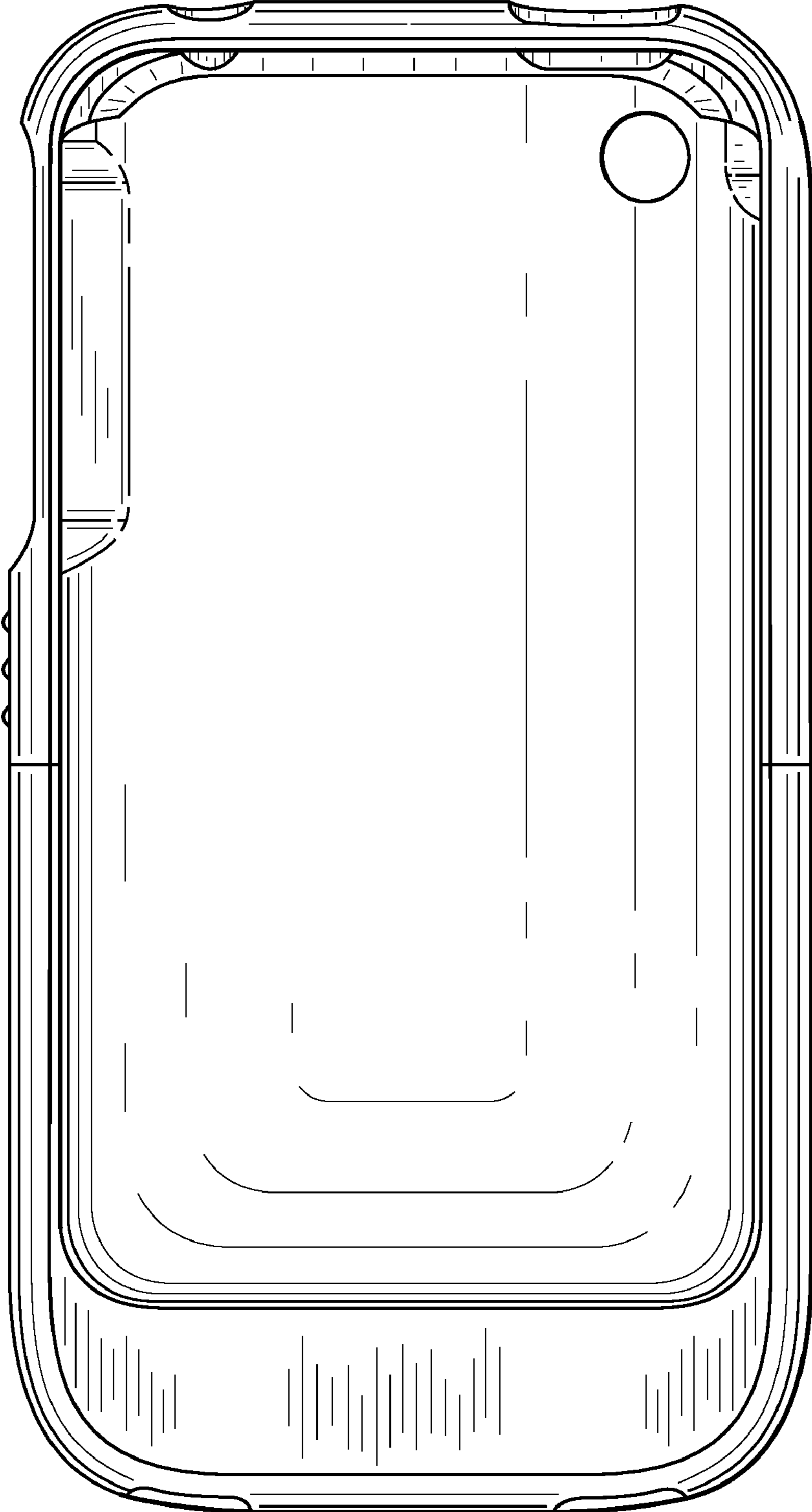




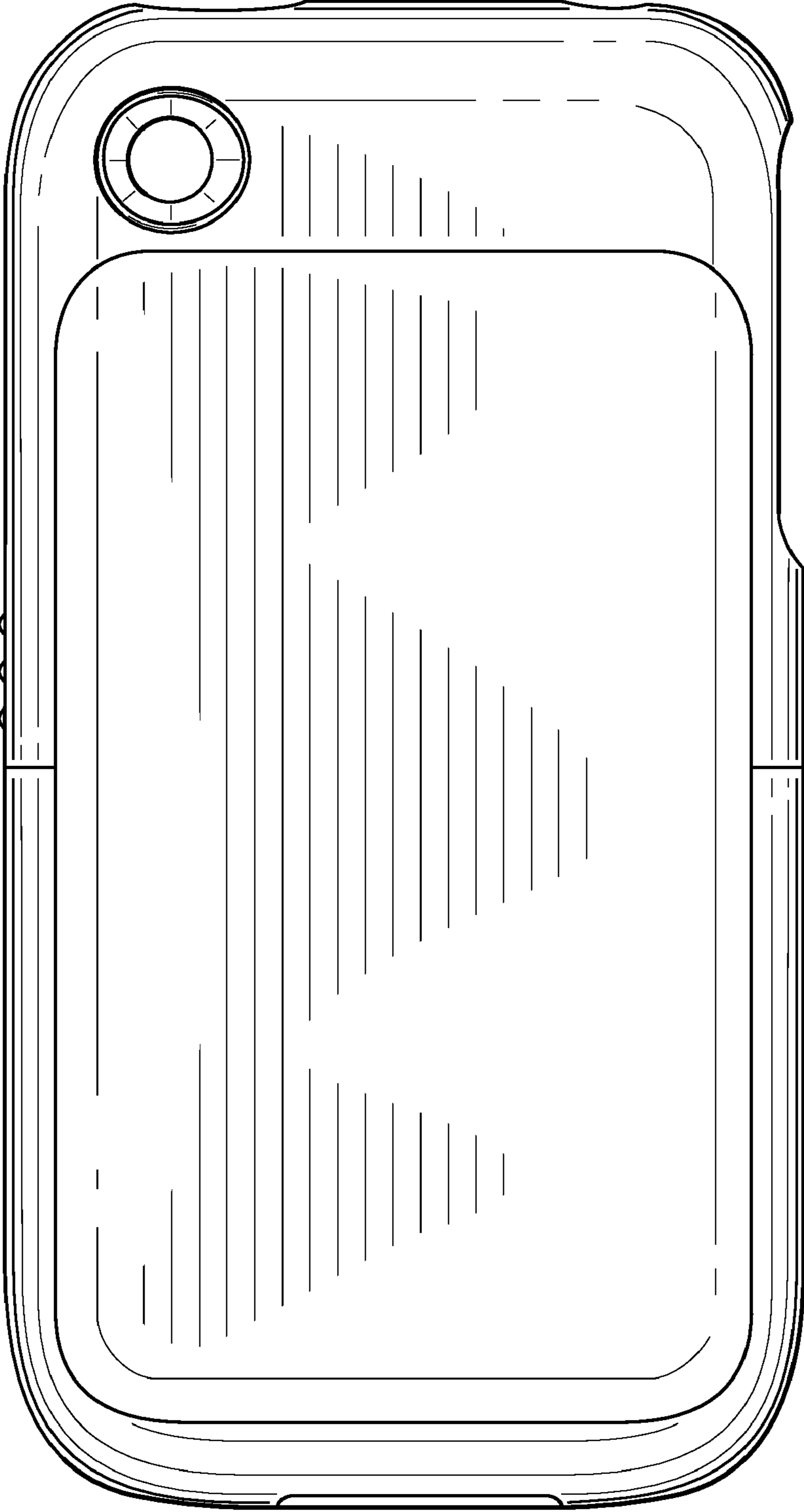
**FIG. 1**



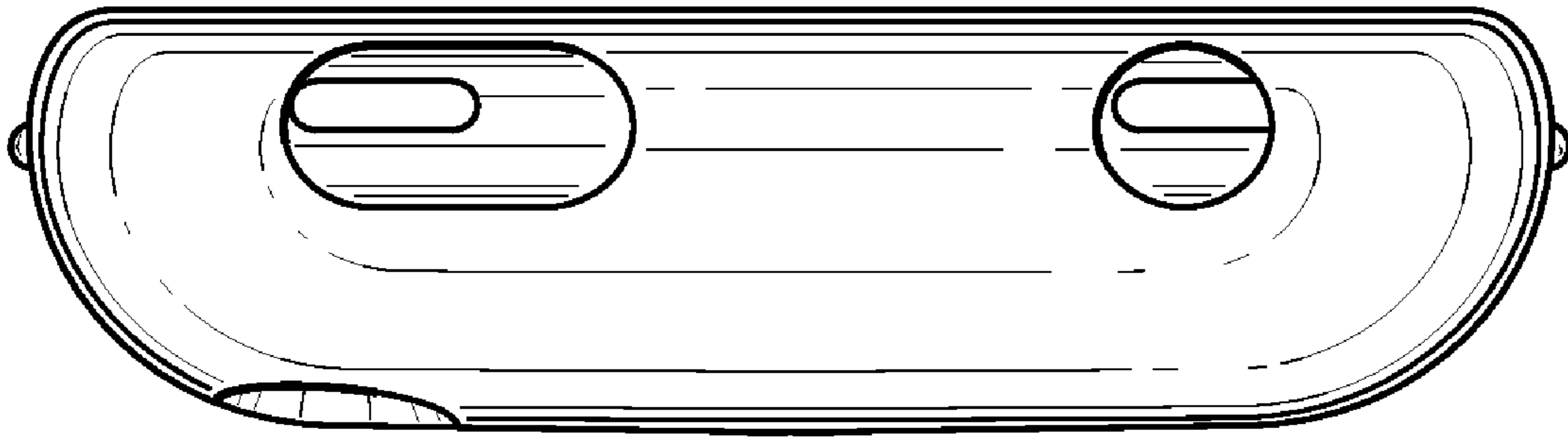
**FIG. 2**



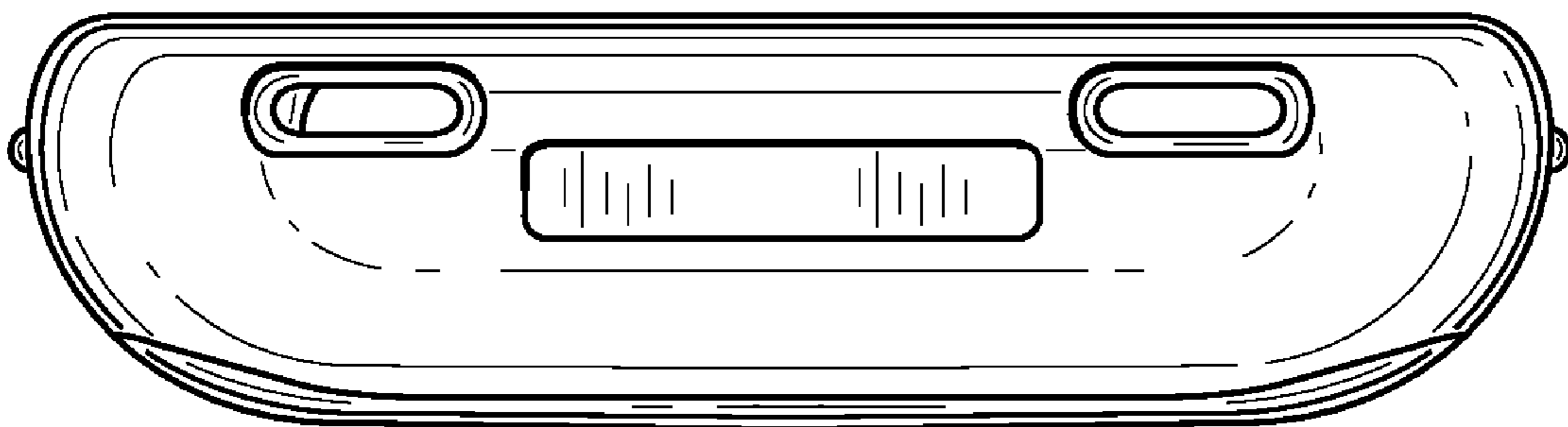
**FIG. 3**



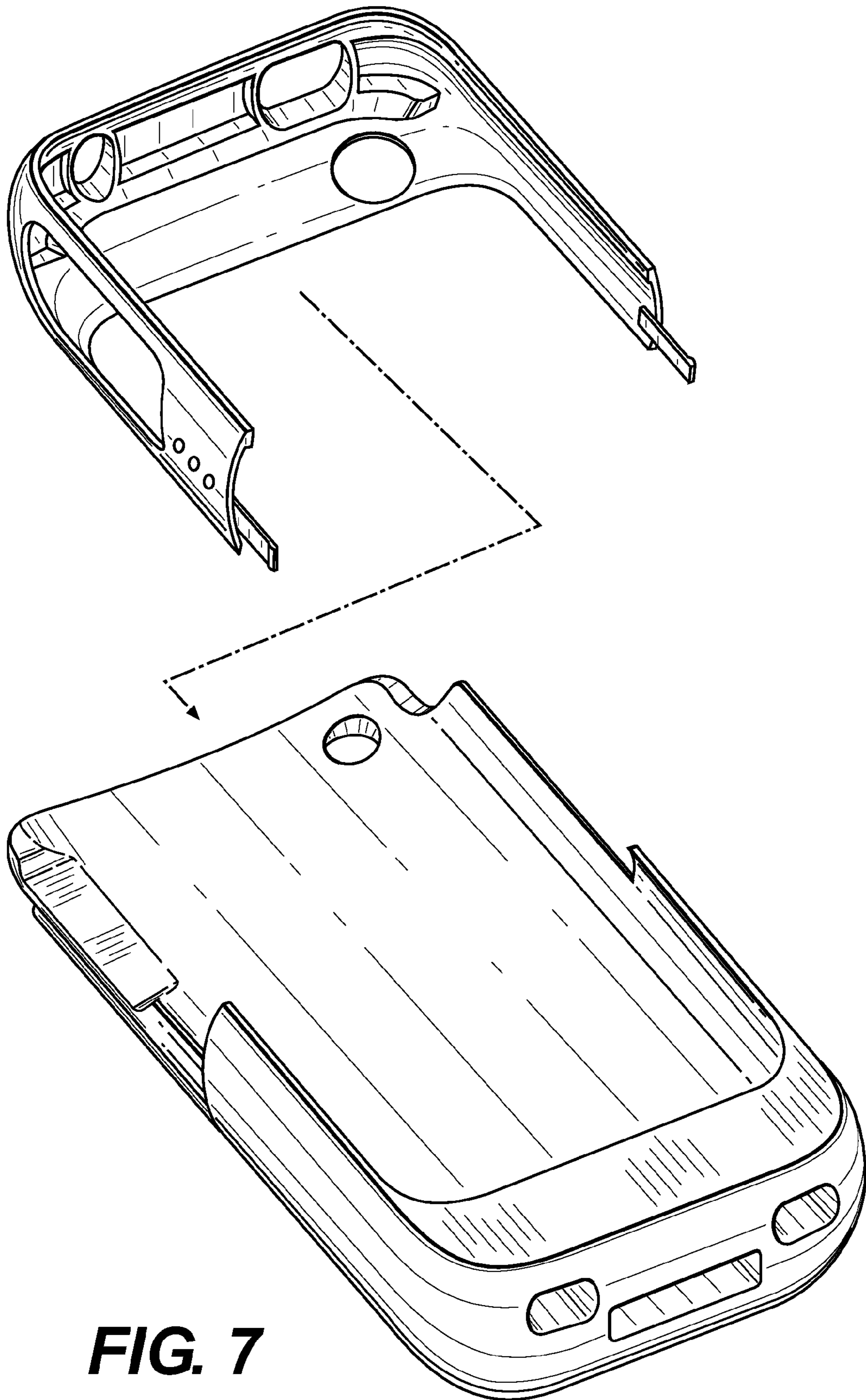
**FIG. 4**



**FIG. 5**



**FIG. 6**



**FIG. 7**