



US00D609422S

(12) **United States Design Patent**  
**Mulka et al.**

(10) **Patent No.:** **US D609,422 S**  
(45) **Date of Patent:** **\*\* Feb. 2, 2010**

(54) **VERTICALLY DIVIDED CART**

(76) Inventors: **William P. Mulka**, 308 Wallace Dr.,  
Saline, MI (US) 48176; **Donald R.**  
**Eaton**, 1665 Sheridan Dr., Ann Arbor,  
MI (US) 48104

(\*\*) Term: **14 Years**

(21) Appl. No.: **29/329,871**

(22) Filed: **Dec. 23, 2008**

(51) **LOC (9) Cl.** ..... **12-02**

(52) **U.S. Cl.** ..... **D34/21**

(58) **Field of Classification Search** ..... D34/12-27;  
280/79.11, 79.2, 47.24, 47.33, 47.2; 211/186  
See application file for complete search history.

(56) **References Cited**

**U.S. PATENT DOCUMENTS**

D205,399	S	*	8/1966	O'Rear	.....	D34/18
5,048,849	A	*	9/1991	Mathews et al.	.....	280/47.35
D324,285	S	*	2/1992	Macy	.....	D34/21
5,108,120	A	*	4/1992	Jarmusz et al.	.....	280/47.2
D333,895	S	*	3/1993	Niemeyer	.....	D34/5
D352,585	S	*	11/1994	Binning	.....	D34/17
D354,597	S	*	1/1995	Crane	.....	D34/21
D439,719	S	*	3/2001	Kleinschmidt	.....	D34/17
D514,767	S	*	2/2006	Schusler et al.	.....	D34/12

D578,270 S 10/2008 Mulka  
D578,724 S 10/2008 Mulka  
D581,124 S 11/2008 Mulka  
2005/0285361 A1\* 12/2005 Gregory et al. .... 280/47.35

\* cited by examiner

*Primary Examiner*—Cynthia E Ramirez

(74) *Attorney, Agent, or Firm*—Young Basile

(57) **CLAIM**

The ornamental design for a vertically divided cart, as shown and described.

**DESCRIPTION**

FIG. 1 is a perspective view of a vertically divided cart showing our new design;

FIG. 2 is a perspective view thereof;

FIG. 3 is a side view thereof;

FIG. 4 is a front view thereof;

FIG. 5 is a top view thereof;

FIG. 6 is a bottom view thereof; and,

FIG. 7 is a rear view thereof.

The broken line showing of articles in FIG. 1 is included for the purpose of illustrating environment and forms no part of the claims and design.

**1 Claim, 5 Drawing Sheets**

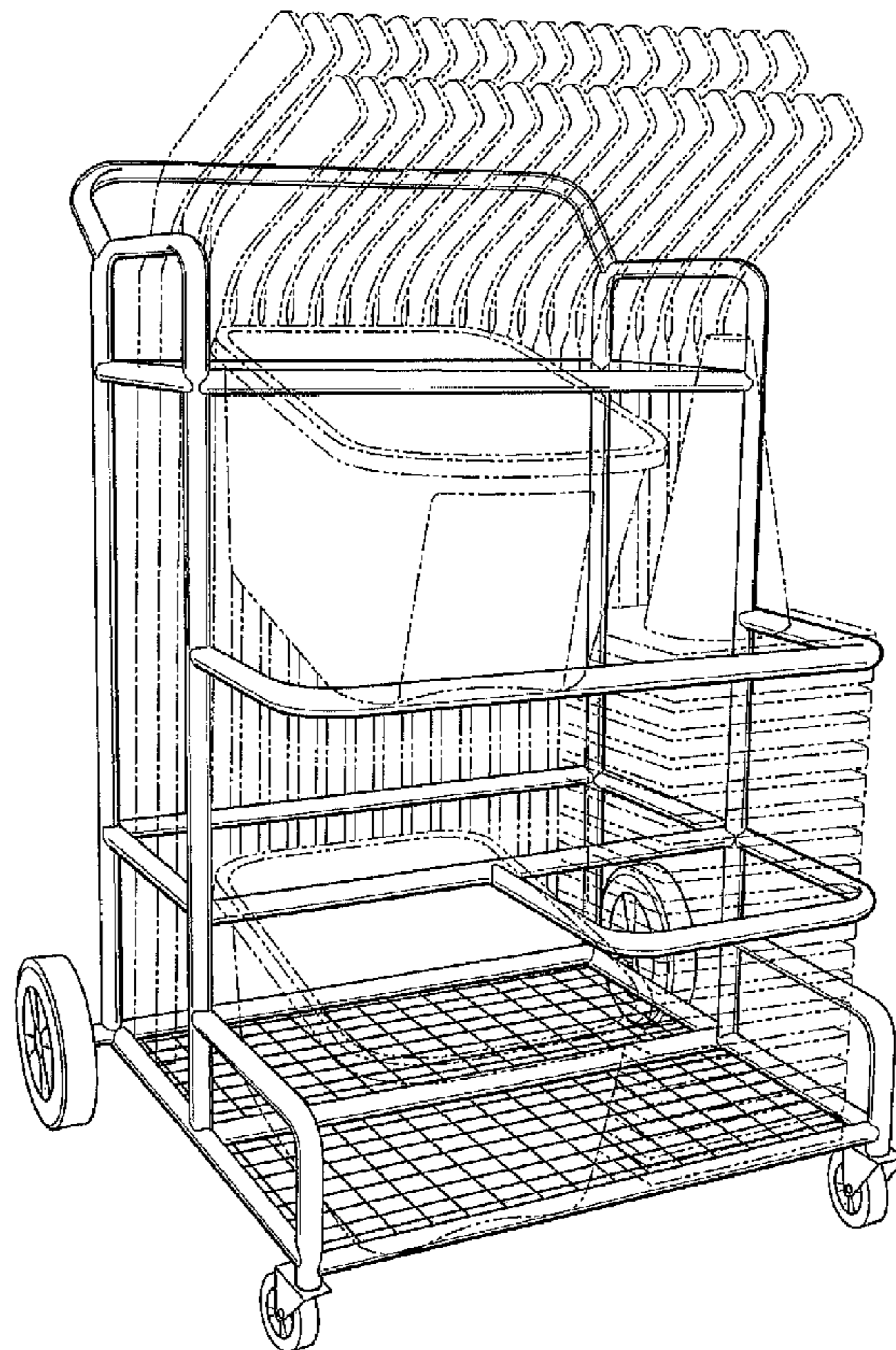

**FIG - 1**

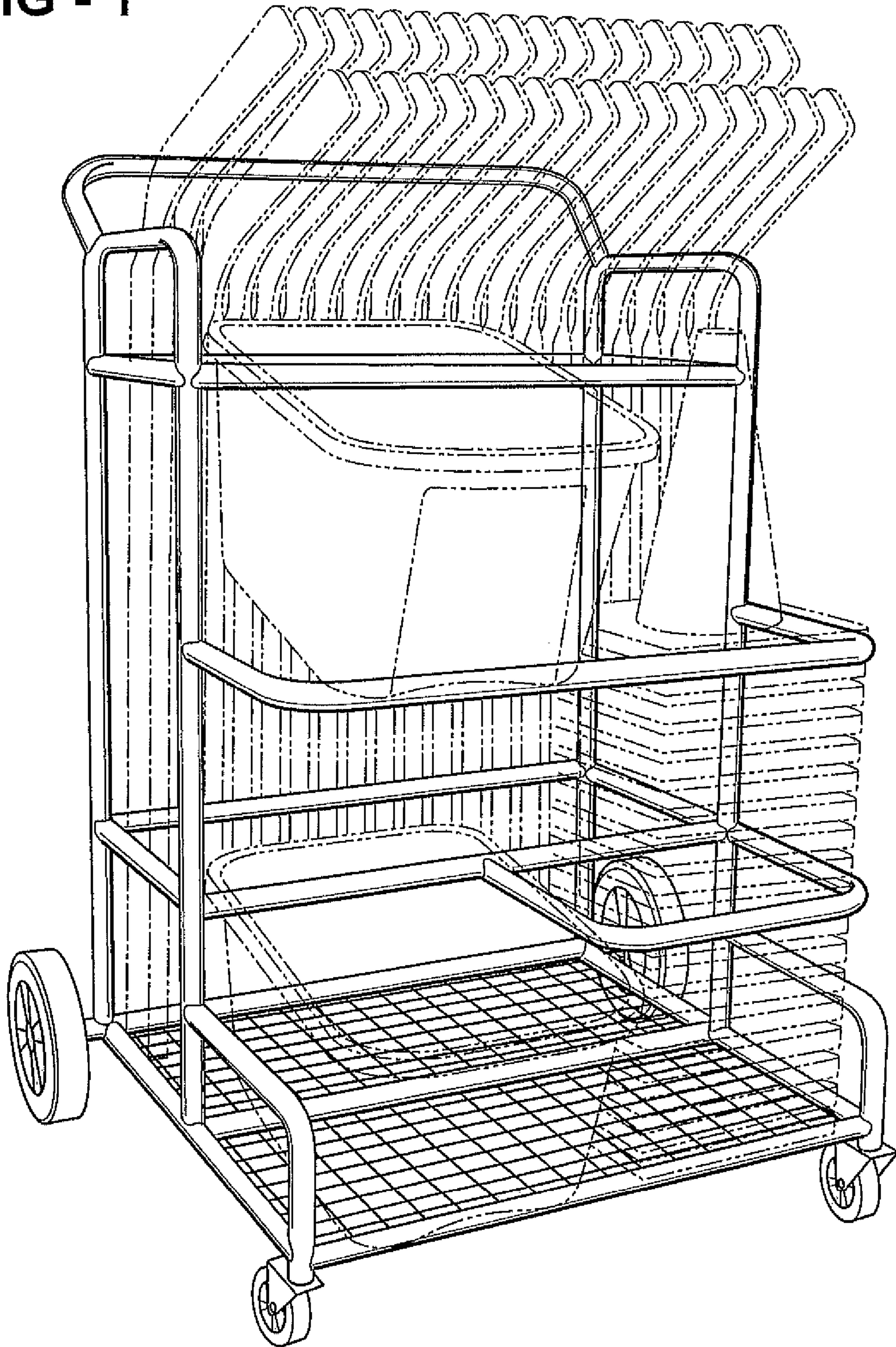
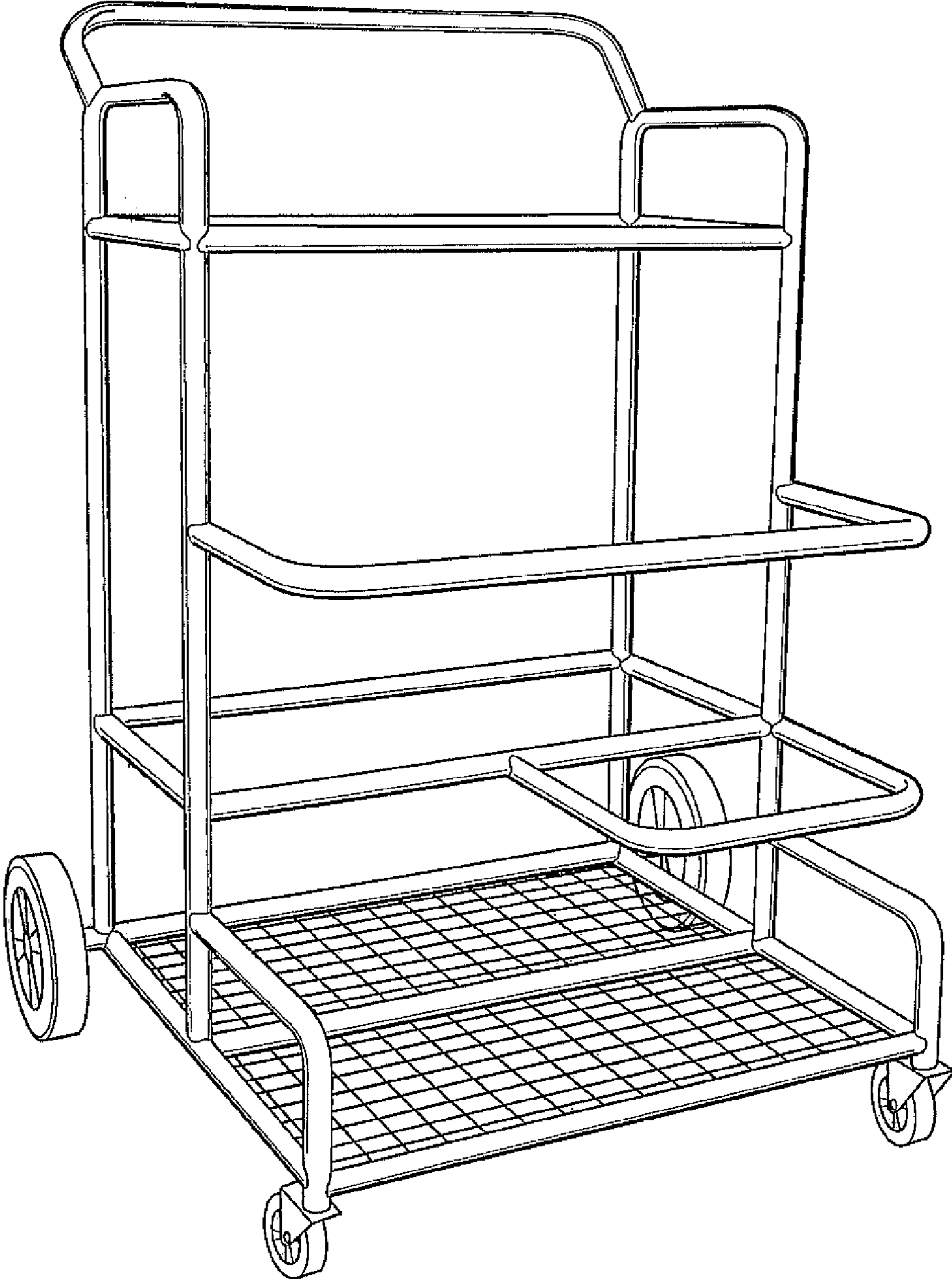

FIG - 2



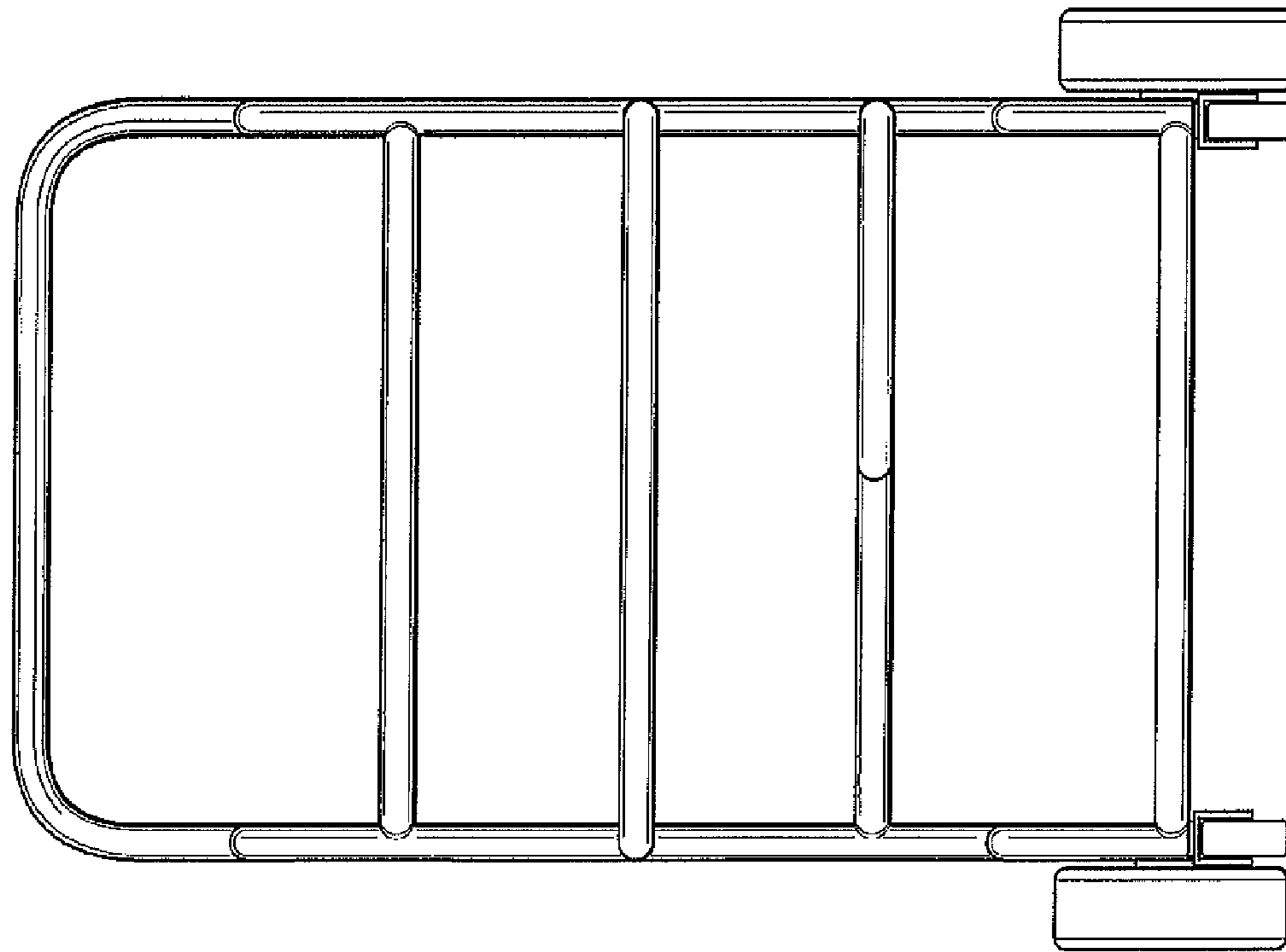

FIG - 4

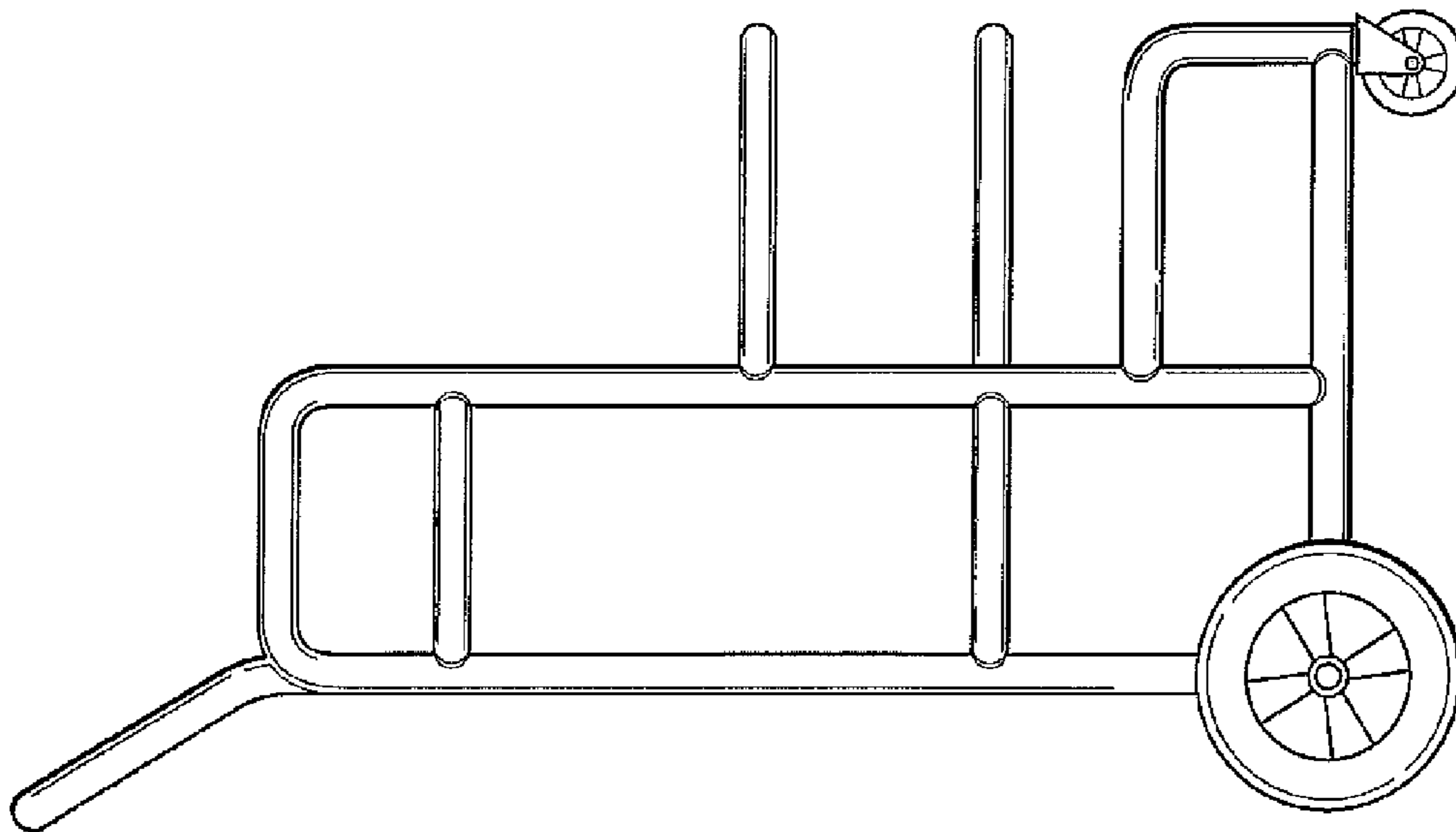
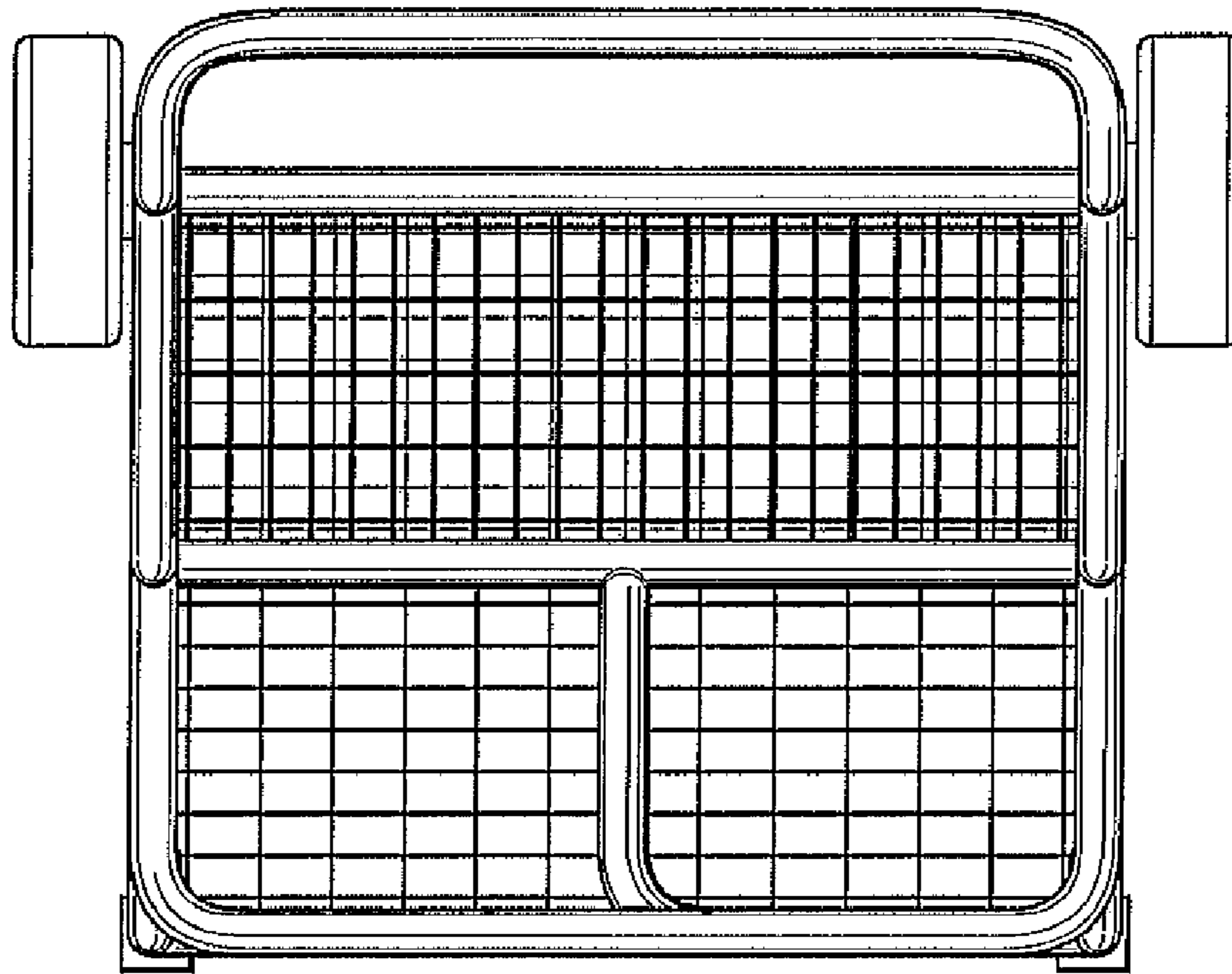
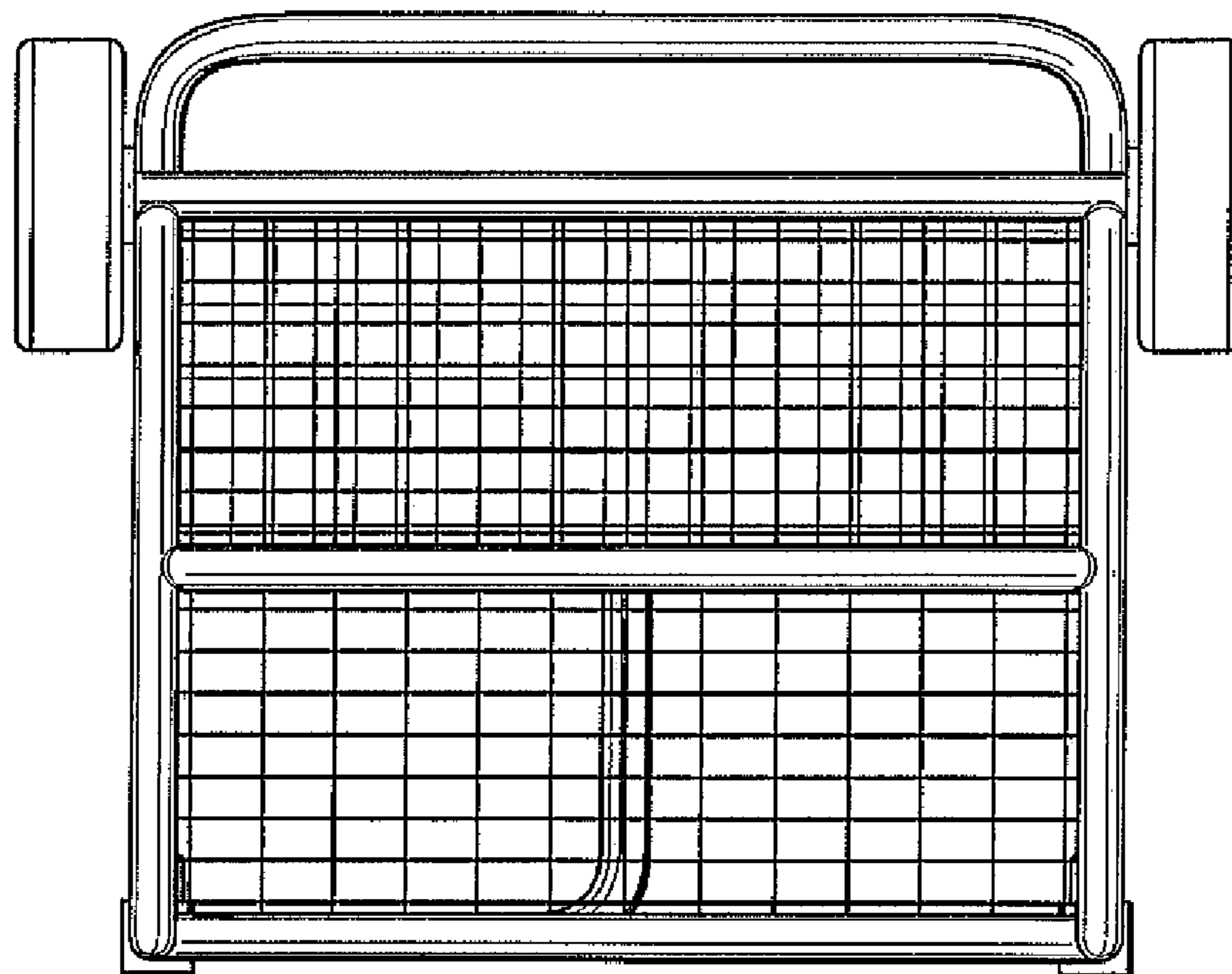

FIG - 3



**FIG - 5**



**FIG - 6**

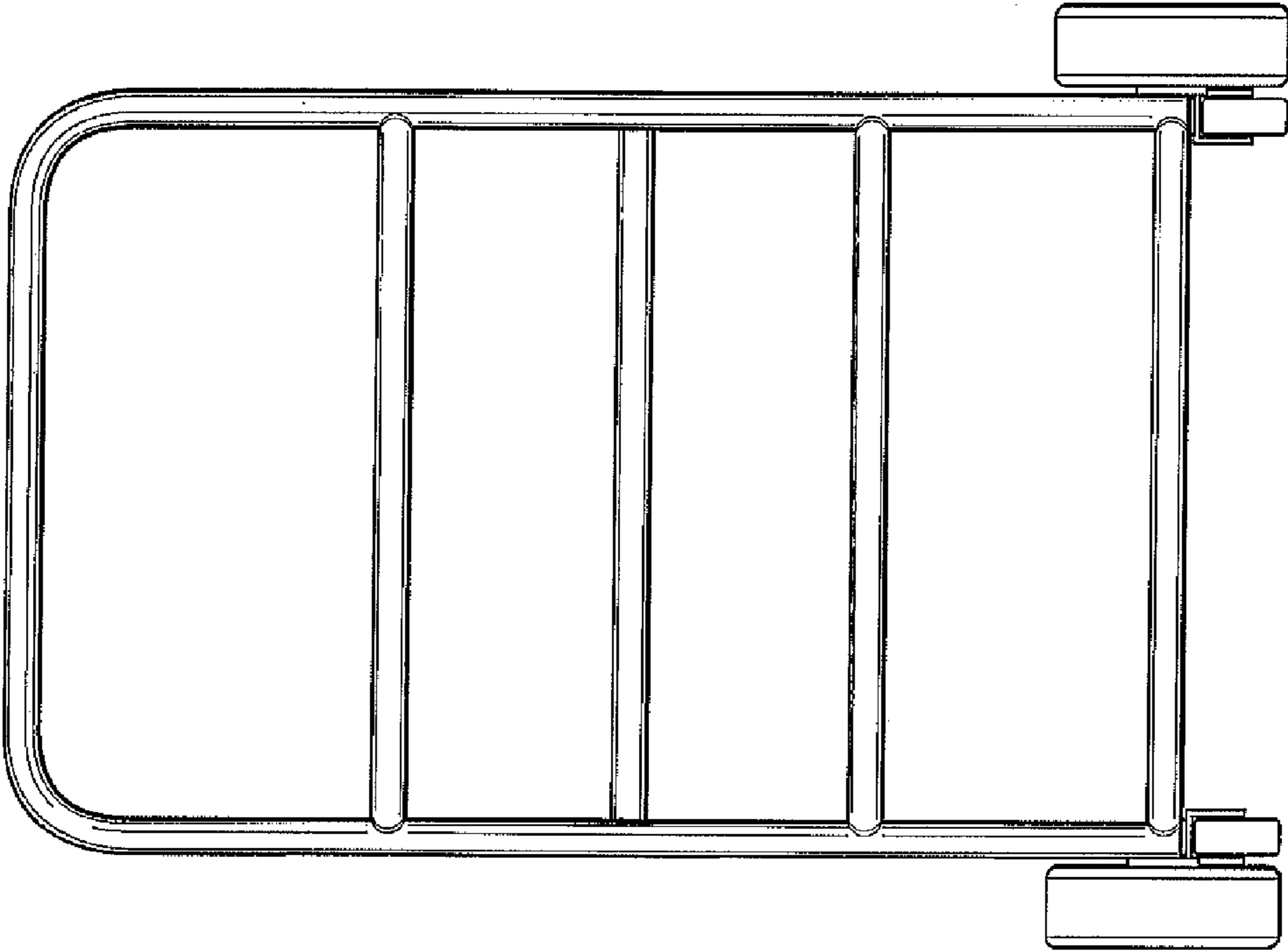

FIG - 7