



US00D609409S

(12) **United States Design Patent**  
**Labelson et al.**

(10) **Patent No.:** **US D609,409 S**

(45) **Date of Patent:** **\*\* Feb. 2, 2010**

(54) **COLLAR WITH LEASH**

(75) Inventors: **Ross Labelson**, Westbury, NY (US);  
**Eric Swope**, Redondo Beach, CA (US)

(73) Assignee: **Buckle-Down, Inc.**, Westbury, NY (US)

(\*\*) Term: **14 Years**

(21) Appl. No.: **29/311,290**

(22) Filed: **Feb. 10, 2009**

(51) **LOC (9) Cl.** ..... **30-04**

(52) **U.S. Cl.** ..... **D30/153**

(58) **Field of Classification Search** ..... 318/257;  
D30/154, 160, 151, 199, 153, 152; 119/707-712,  
119/786-788, 791, 780, 782, 769-771, 792-799,  
119/758, 760, 784, 802, 856, 857, 863, 865,  
119/719, 859, 908, 776; D21/791, 840; D8/1,  
D8/14, 47; 248/121, 521, 545, 499, 145,  
248/156, 508, 530, 125.1, 125.3, 125.8, 690;  
211/205; 52/155, 166, 157, 162, 163; 135/118;  
403/360, 378; 473/149, 147; D26/138; 362/401;  
410/101; 405/259.1, 244; 182/3; 24/523,  
24/525, 299, 594.11, DIG. 35, 3.2, 600.7,  
24/905; D24/199; 54/71, 34; 267/133, 136,  
267/34, 70-72; 16/66; 340/575.3, 668; 294/82.34,  
294/19.1; 114/221 R; 441/75; 128/878,  
128/882, DIG. 15; D29/120.1-120.2, 100,  
D29/101.1; D2/627, 624, 631

See application file for complete search history.

(56) **References Cited**

**U.S. PATENT DOCUMENTS**

1,882,475 A \* 10/1932 Blickhahn ..... 40/640  
2,909,154 A \* 10/1959 Thomas ..... 119/771  
3,378,895 A \* 4/1968 Eberhart ..... 24/650  
4,035,877 A \* 7/1977 Brownson et al. .... 24/323

4,195,392 A \* 4/1980 Ueda et al. .... 24/637  
4,584,967 A \* 4/1986 Taplin ..... 119/793  
4,896,630 A \* 1/1990 Luce ..... 119/771  
4,932,362 A \* 6/1990 Birchmire et al. .... 119/772

(Continued)

*Primary Examiner*—Susan Moon Lee

(74) *Attorney, Agent, or Firm*—Jones Day

(57) **CLAIM**

The ornamental design for a collar with leash, as shown and described.

**DESCRIPTION**

FIG. 1 is a first perspective view of a collar with leash showing my new design, shown in a fastened condition;

FIG. 2 is a close-up front view of the collar with female buckle receiver portion of the invention shown with the leash band with male connector element removed;

FIG. 3 is a first close-up side view of the collar with female buckle receiver portion of the invention shown with the leash band portion shown broken away on the left side;

FIG. 4 is a second close-up side view of the collar with female buckle receiver portion of the invention shown with the leash band portion shown broken away on the right side;

FIG. 5 is a top view of the collar with female buckle receiver portion of the invention shown with the leash band portion shown just cut away at the seam of the leash belt portion;

FIG. 6 is a rear close-up view of the collar portion of the invention shown with the leash band part removed; and,

FIG. 7 is a second perspective view of the collar with leash shown in an unfastened condition.

The stitching lines are not claimed. The remaining portions depicted in broken line are also not claimed.

**1 Claim, 4 Drawing Sheets**

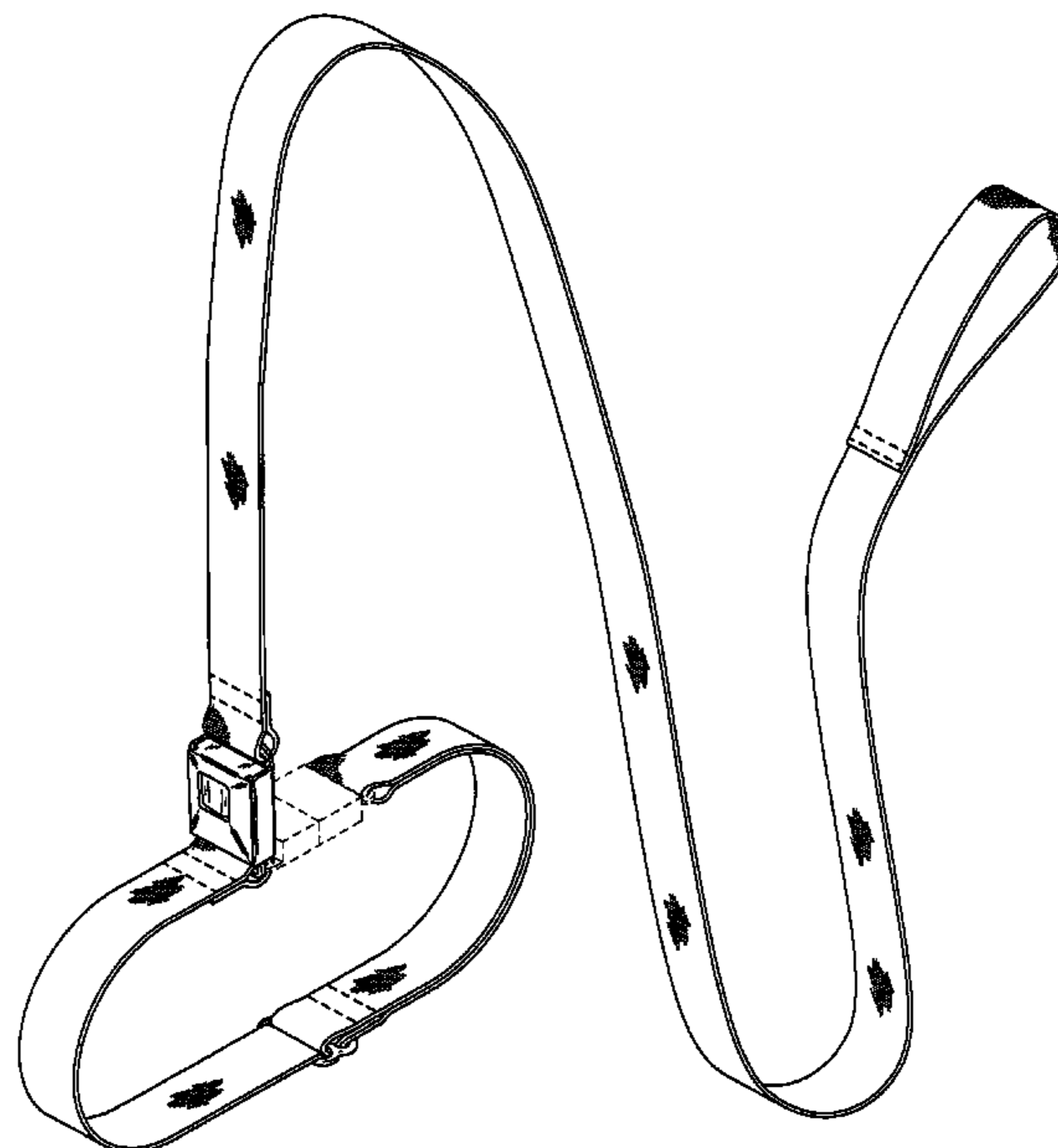

# US D609,409 S

Page 2

## U.S. PATENT DOCUMENTS

D322,160	S *	12/1991	Dauterive	.....	D2/627	6,626,132	B1 *	9/2003	Mann	.....	119/795
5,099,799	A *	3/1992	Giacobbe	.....	119/793	D489,867	S *	5/2004	Stahl	.....	D2/639
5,131,682	A *	7/1992	Reed	.....	280/801.1	D495,853	S *	9/2004	Nelson	.....	D2/627
5,154,660	A *	10/1992	Snyder et al.	.....	119/771	6,834,621	B1 *	12/2004	O'Neill	.....	119/771
D350,628	S *	9/1994	Williams	.....	D30/153	6,971,334	B1 *	12/2005	Livesay et al.	.....	119/798
D353,932	S *	1/1995	New	.....	D2/627	D542,523	S *	5/2007	Labelson	.....	D3/208
5,517,949	A *	5/1996	Harris et al.	.....	119/795	D544,707	S *	6/2007	Labelson	.....	D3/208
5,624,135	A *	4/1997	Symonds	.....	280/801.1	D547,053	S *	7/2007	Labelson	.....	D3/208
5,806,467	A *	9/1998	Arakawa	.....	119/771	7,281,495	B2 *	10/2007	Wagner	.....	119/793
5,813,367	A *	9/1998	O'Brien	.....	119/770	7,591,510	B1 *	9/2009	Giampavolo	.....	297/256.17
5,947,062	A *	9/1999	Hoffman et al.	.....	119/769	2004/0112303	A1 *	6/2004	Moulton, III	.....	119/795
6,192,835	B1 *	2/2001	Calhoun et al.	.....	119/792	2006/0288960	A1 *	12/2006	Harrison	.....	119/794
6,367,428	B1 *	4/2002	Forte	.....	119/863	2007/0022974	A1 *	2/2007	Aebi	.....	119/795

\* cited by examiner

FIG. 1

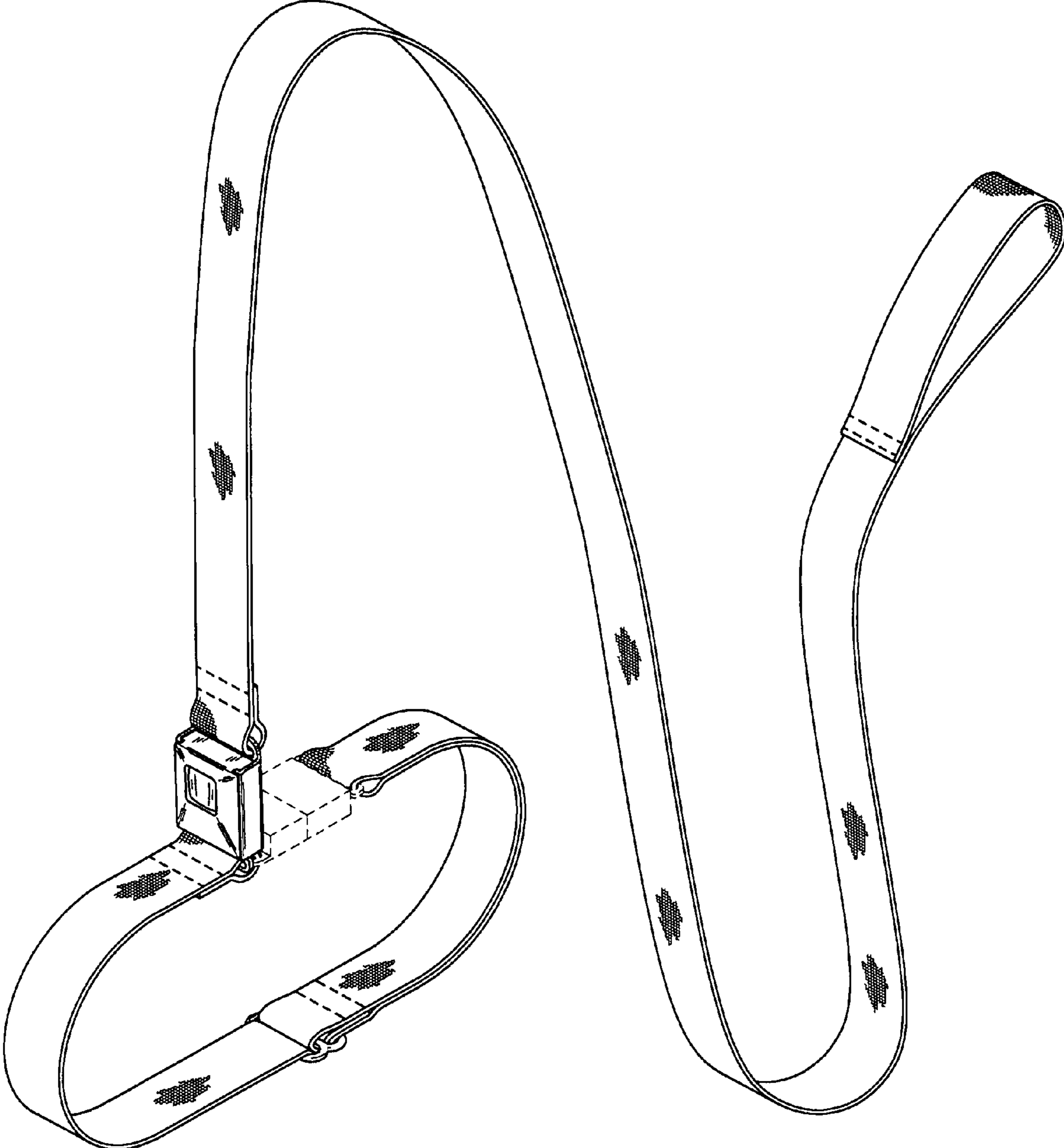

FIG. 2

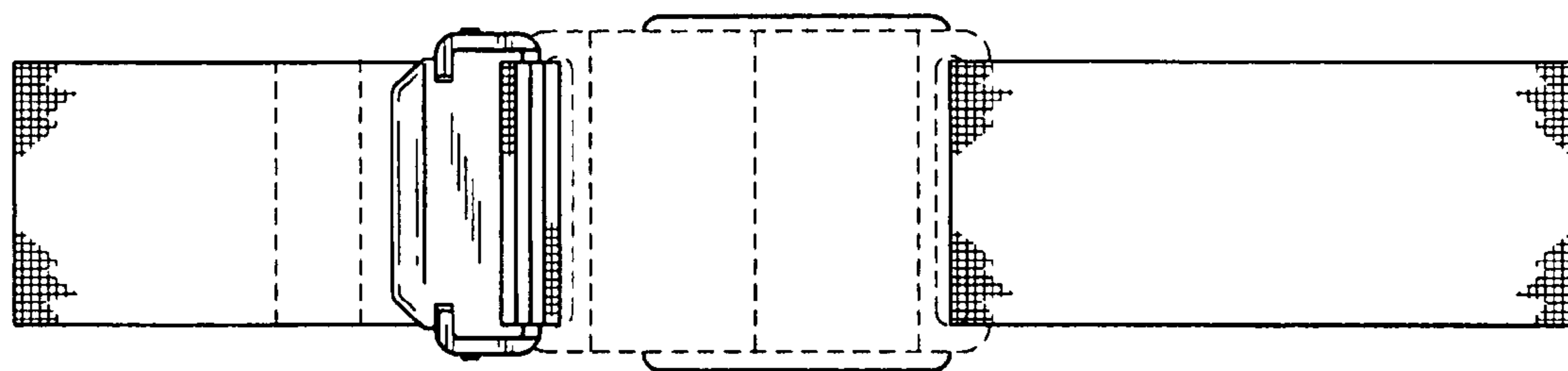

FIG. 3

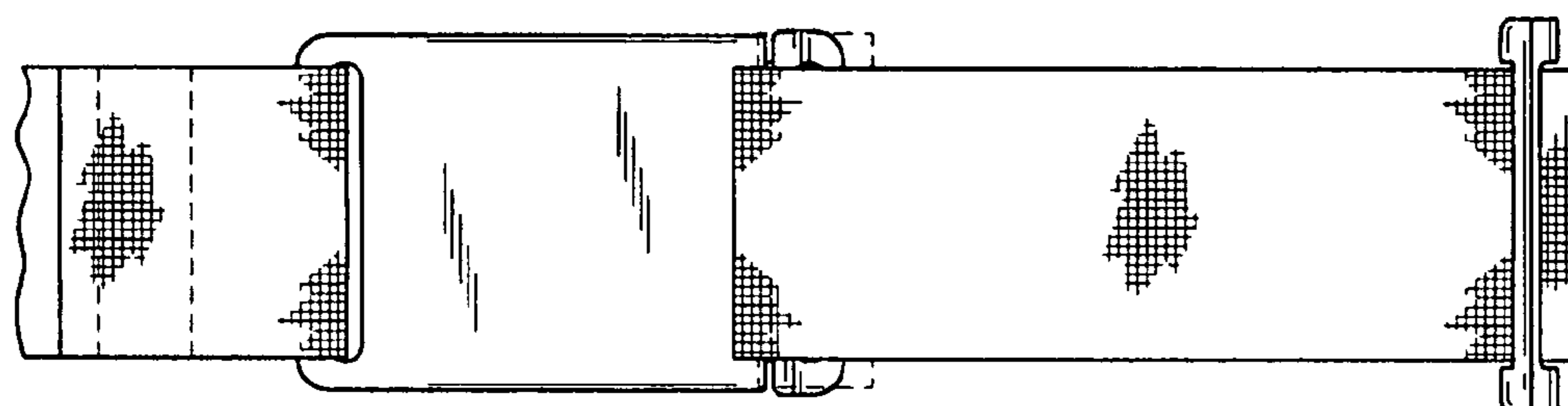

FIG. 4

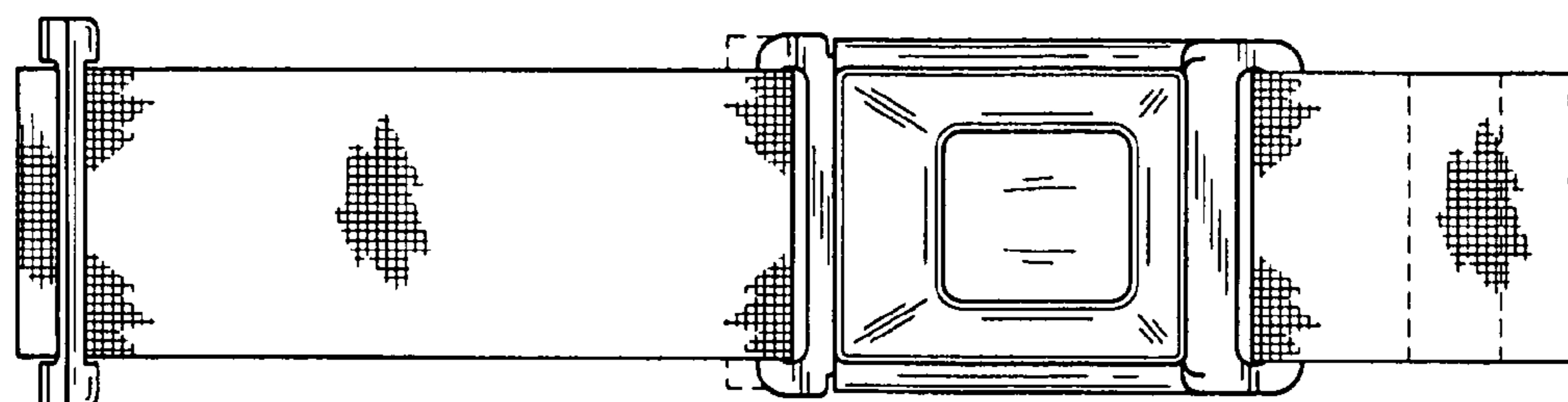

FIG. 5

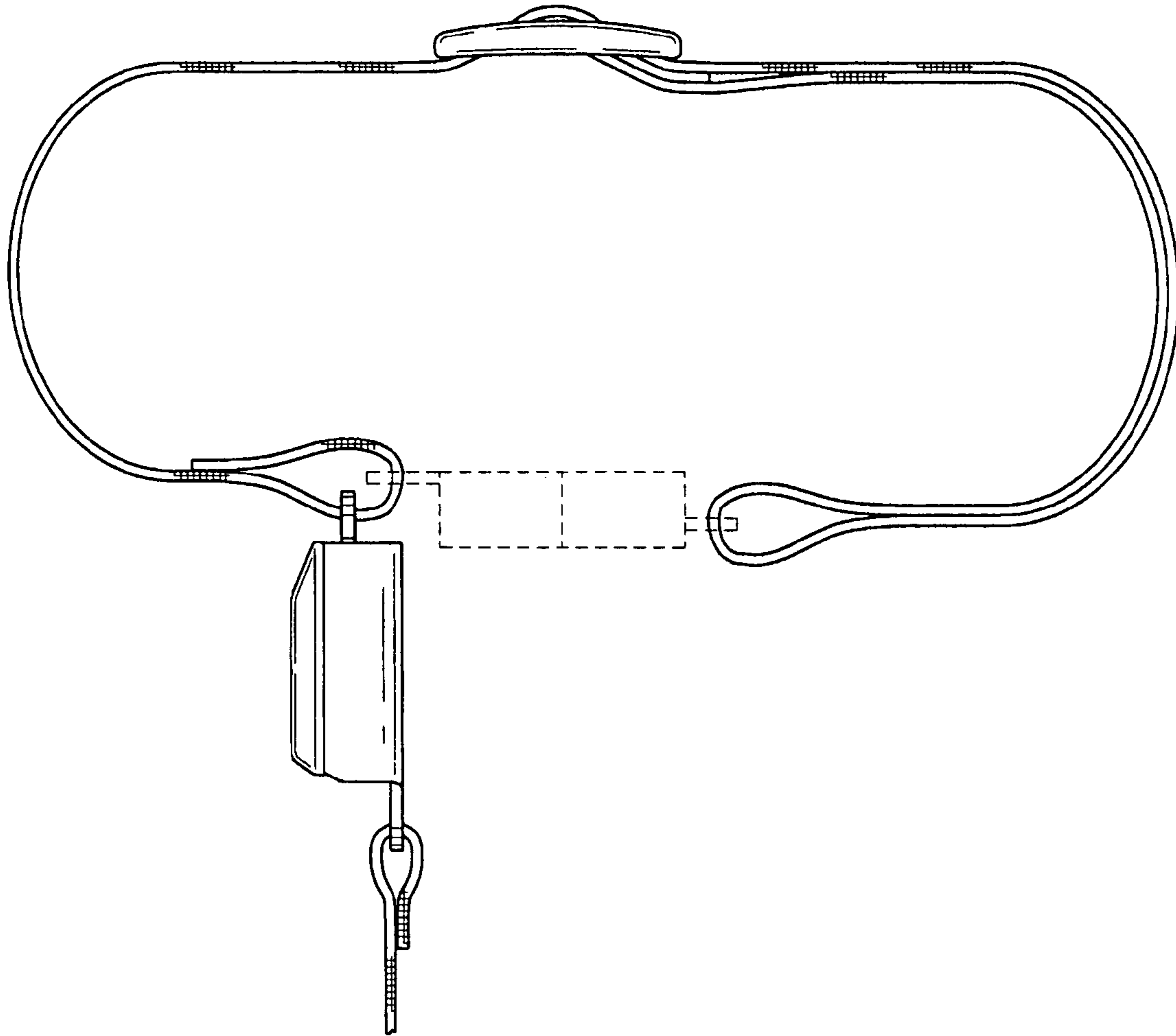

FIG. 6

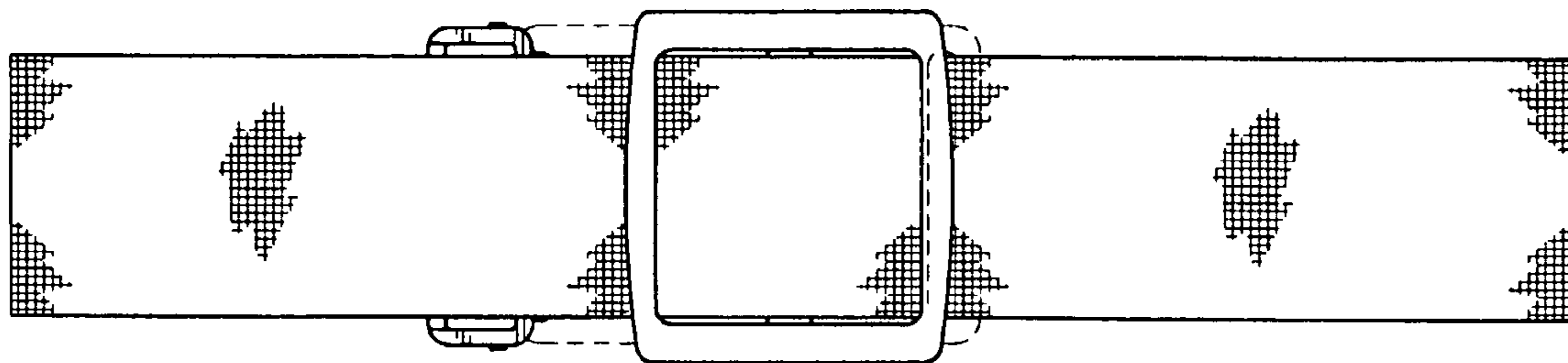

FIG. 7

