



(12) **United States Design Patent**
Myers

(10) **Patent No.:** **US D609,339 S**
(45) **Date of Patent:** **** Feb. 2, 2010**

(54) **TATTOO DEVICE WITH FINGER RECESS**

Primary Examiner—Ian Simmons
Assistant Examiner—Carissa C Fitts

(76) **Inventor:** **Todd Myers**, 1530 Elk Grove Ave., Unit J, Chicago, IL (US) 60622

(57) **CLAIM**

(**) **Term:** **14 Years**

The ornamental design for a tattoo device with finger recess, as shown and described.

(21) **Appl. No.:** **29/299,520**

(22) **Filed:** **Dec. 28, 2007**

DESCRIPTION

(51) **LOC (9) Cl.** **24-02**

FIG. 1 is a top plan view of the handgrip for tattoo device with finger recess showing my new design;

(52) **U.S. Cl.** **D24/133**

FIG. 2 is a bottom plan view thereof;

(58) **Field of Classification Search** D24/133,
D24/140; 606/186, 167, 9; D19/55

FIG. 3 is a front view thereof;

See application file for complete search history.

FIG. 4 is a rear view thereof;

(56) **References Cited**

FIG. 5 is a left side view thereof;

U.S. PATENT DOCUMENTS

FIG. 6 is a right side view thereof;

D373,143 S * 8/1996 Jagger D19/55

FIG. 7 is a left perspective view thereof;

D380,046 S * 6/1997 Domanowski D24/144

FIG. 8 is a right perspective view thereof;

D396,059 S * 7/1998 Plantz et al. D19/55

FIG. 9 is a bottom left perspective view thereof;

D432,168 S * 10/2000 Provda D19/55

FIG. 10 is a bottom right perspective view thereof; and,

6,626,927 B1 * 9/2003 Koplen 606/185

FIG. 11 is a perspective view thereof.

7,393,114 B2 * 7/2008 Devlin 362/109

The broken line showing is for environmental purposes only and forms no part of the claimed design.

* cited by examiner

1 Claim, 2 Drawing Sheets

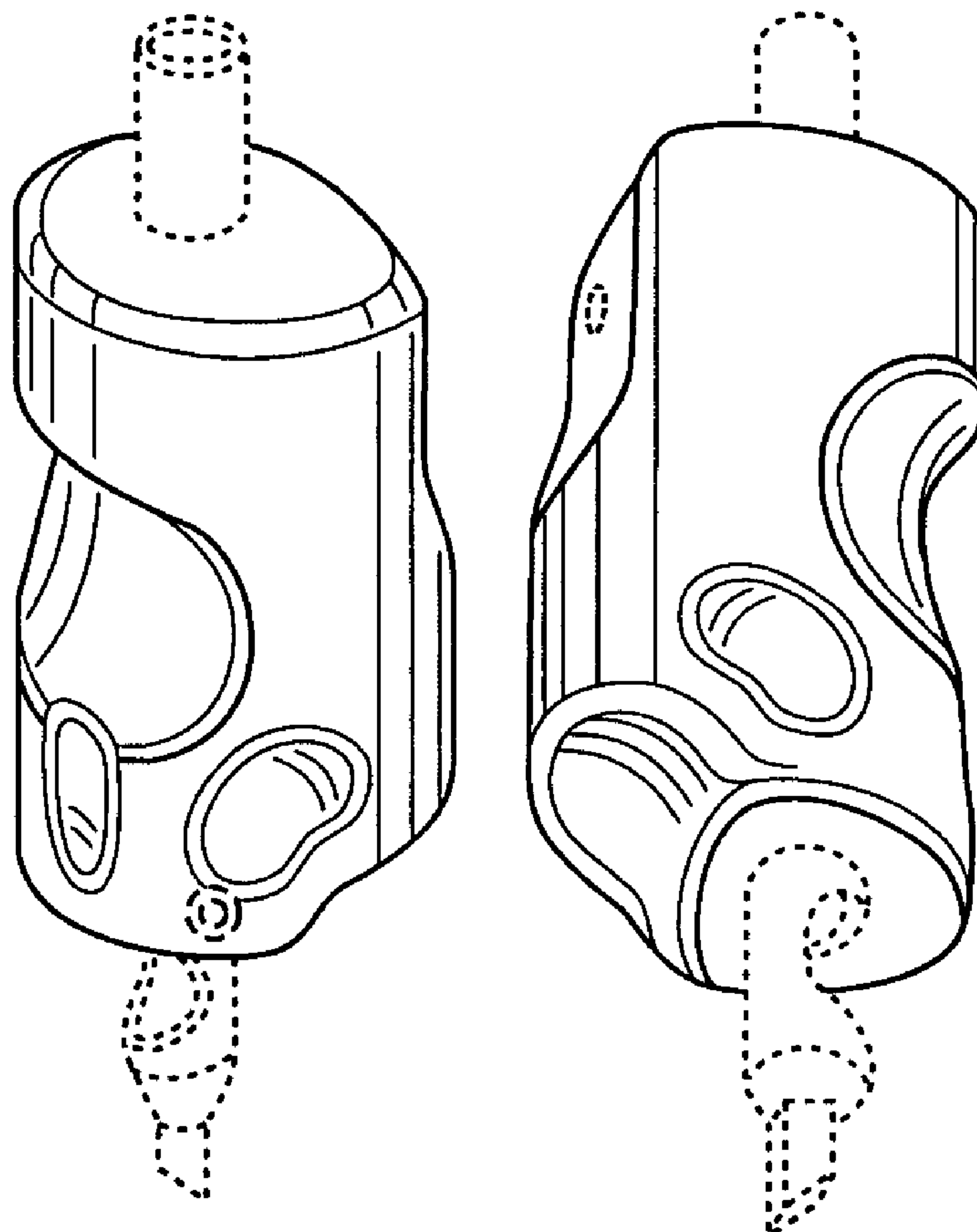

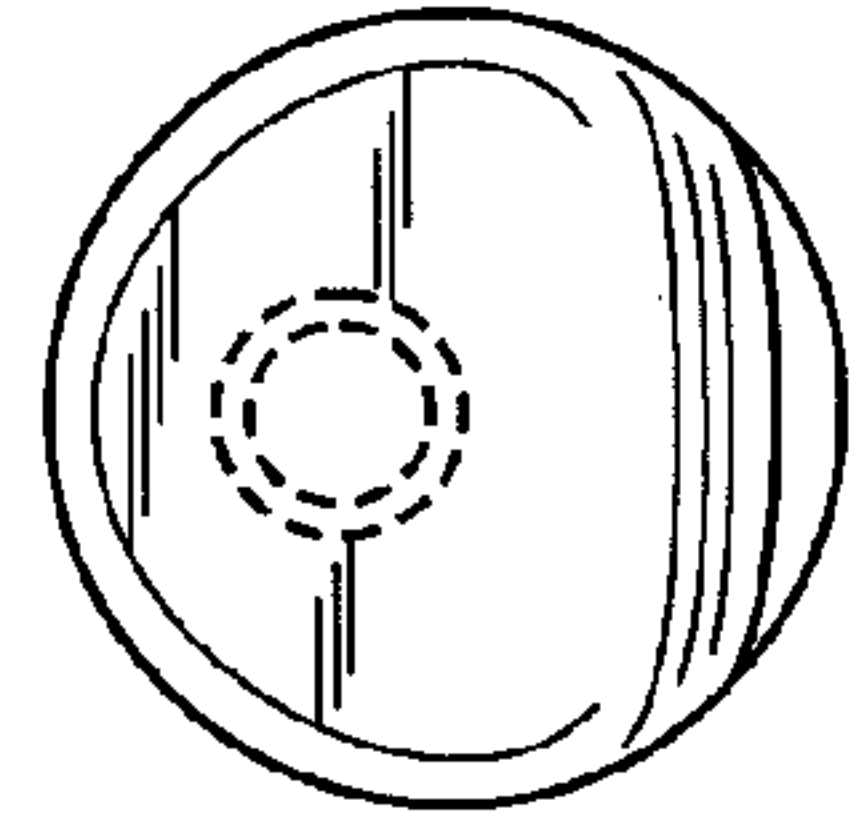

Fig. 1

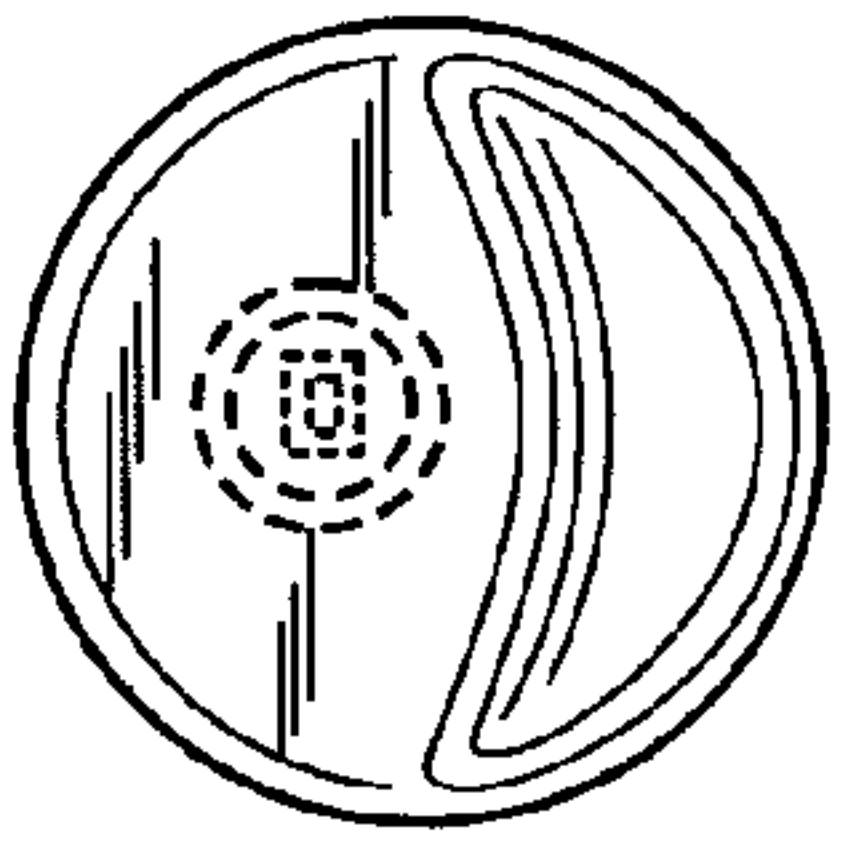

Fig. 2

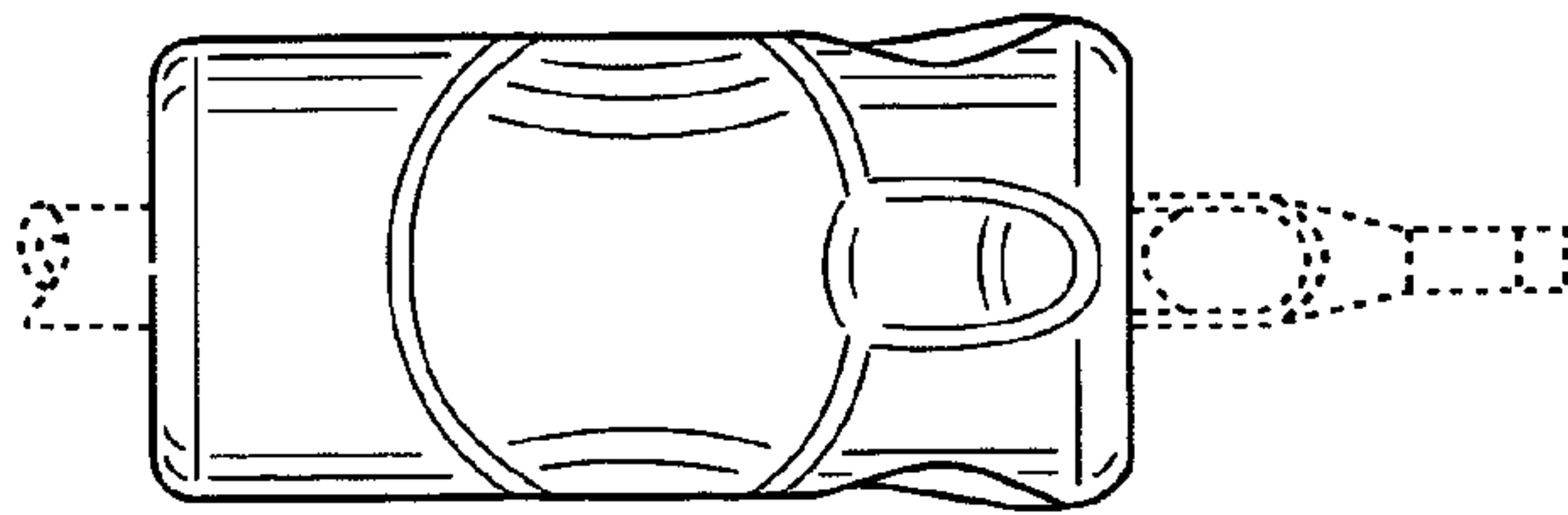

Fig. 3

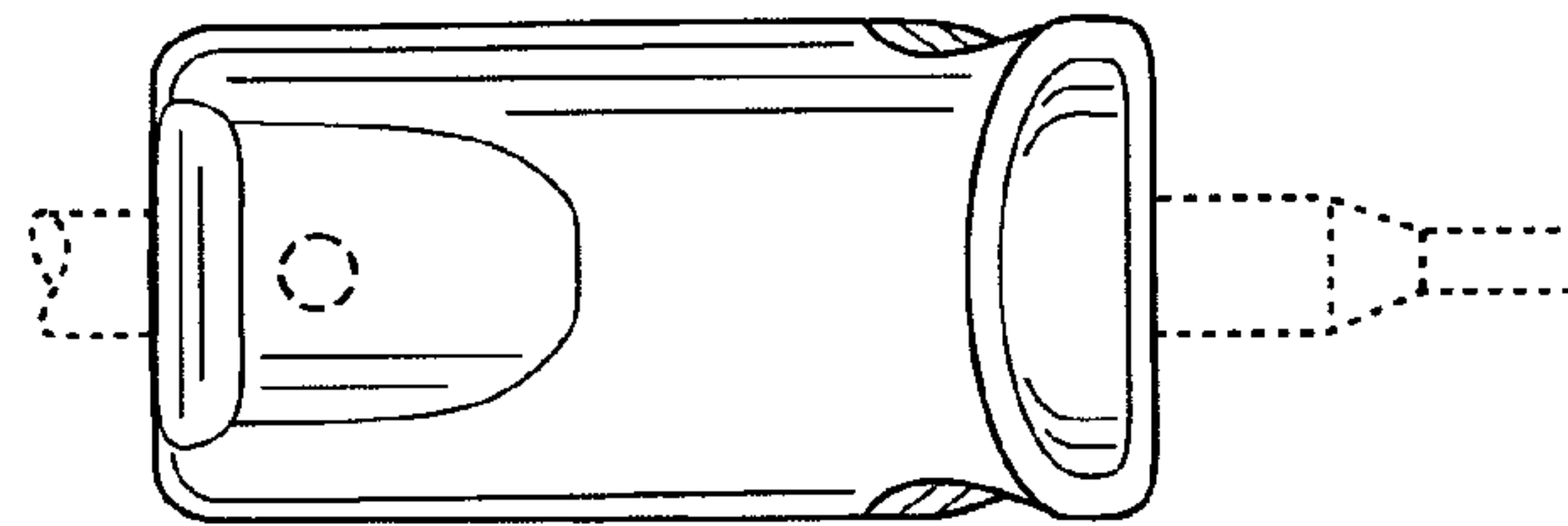

Fig. 4

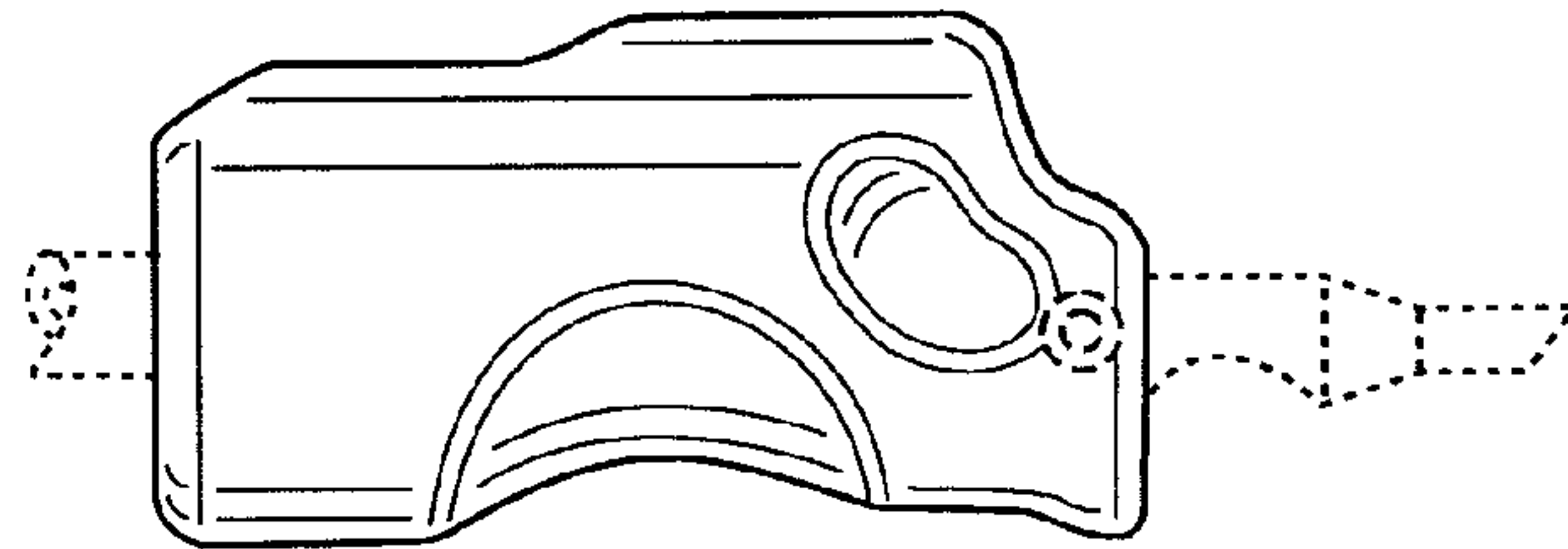

Fig. 5

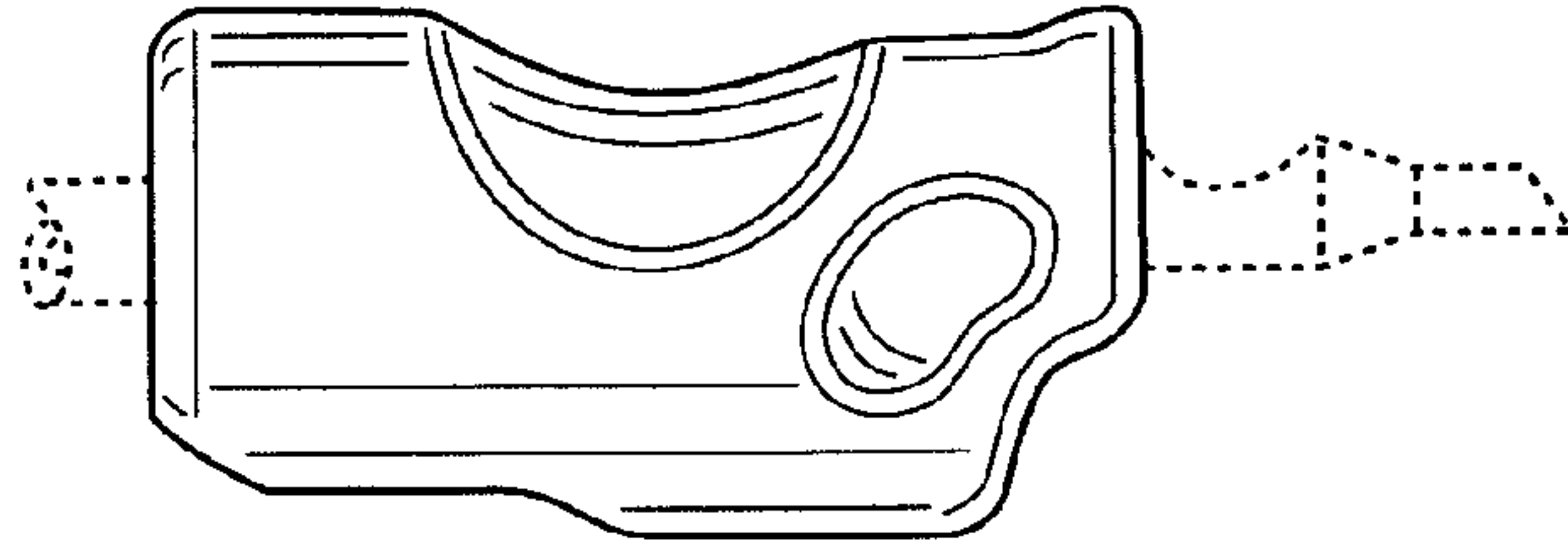

Fig. 6

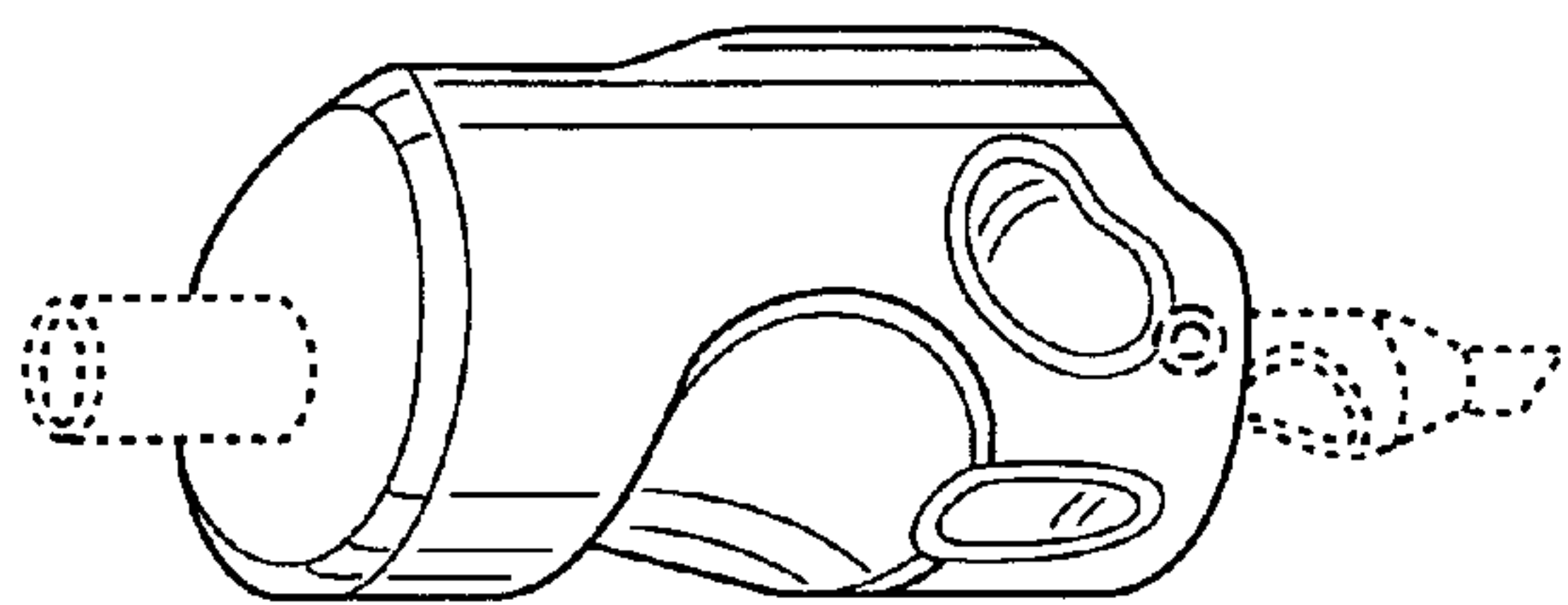

Fig. 7

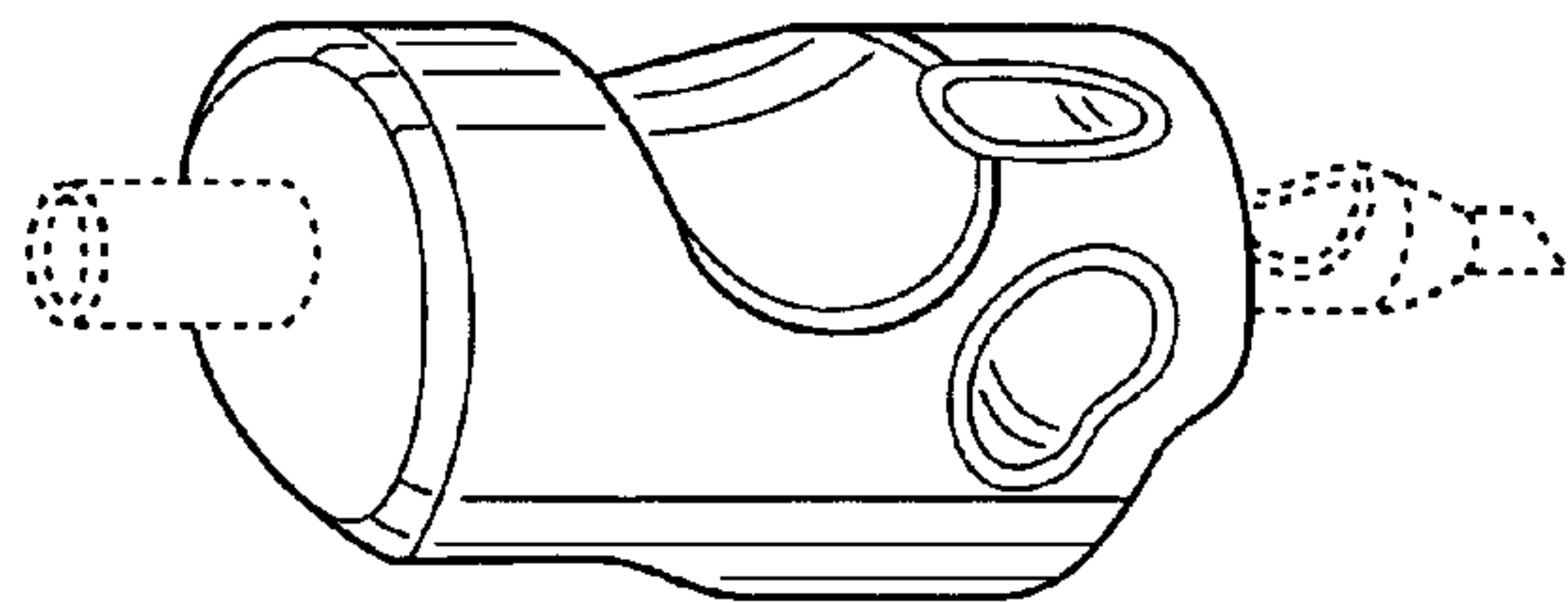

Fig. 8

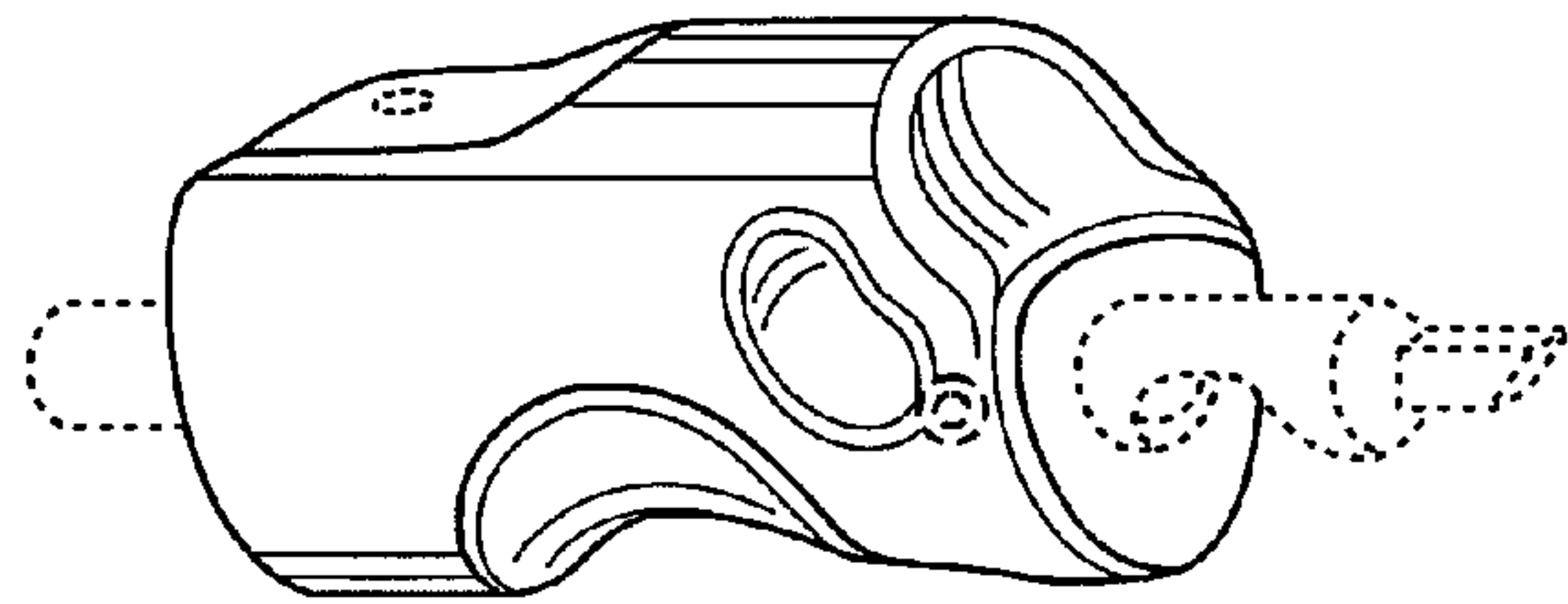

Fig. 9

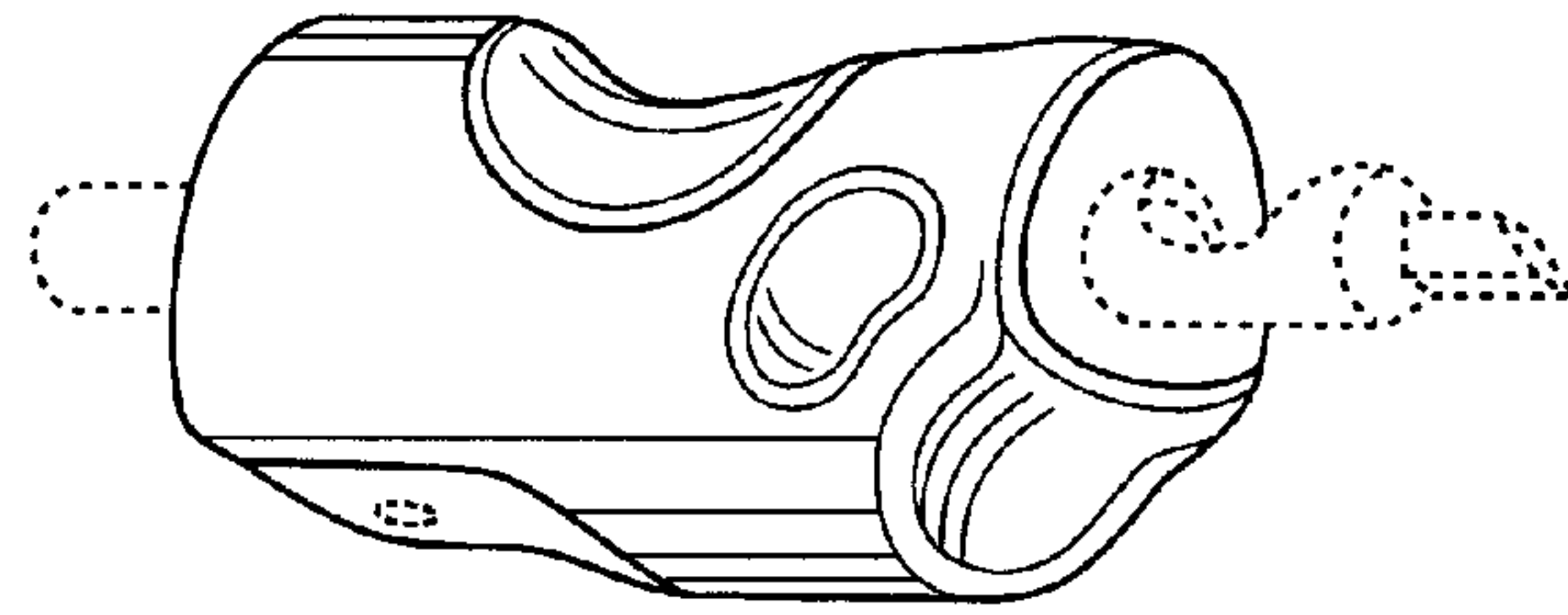

Fig. 10

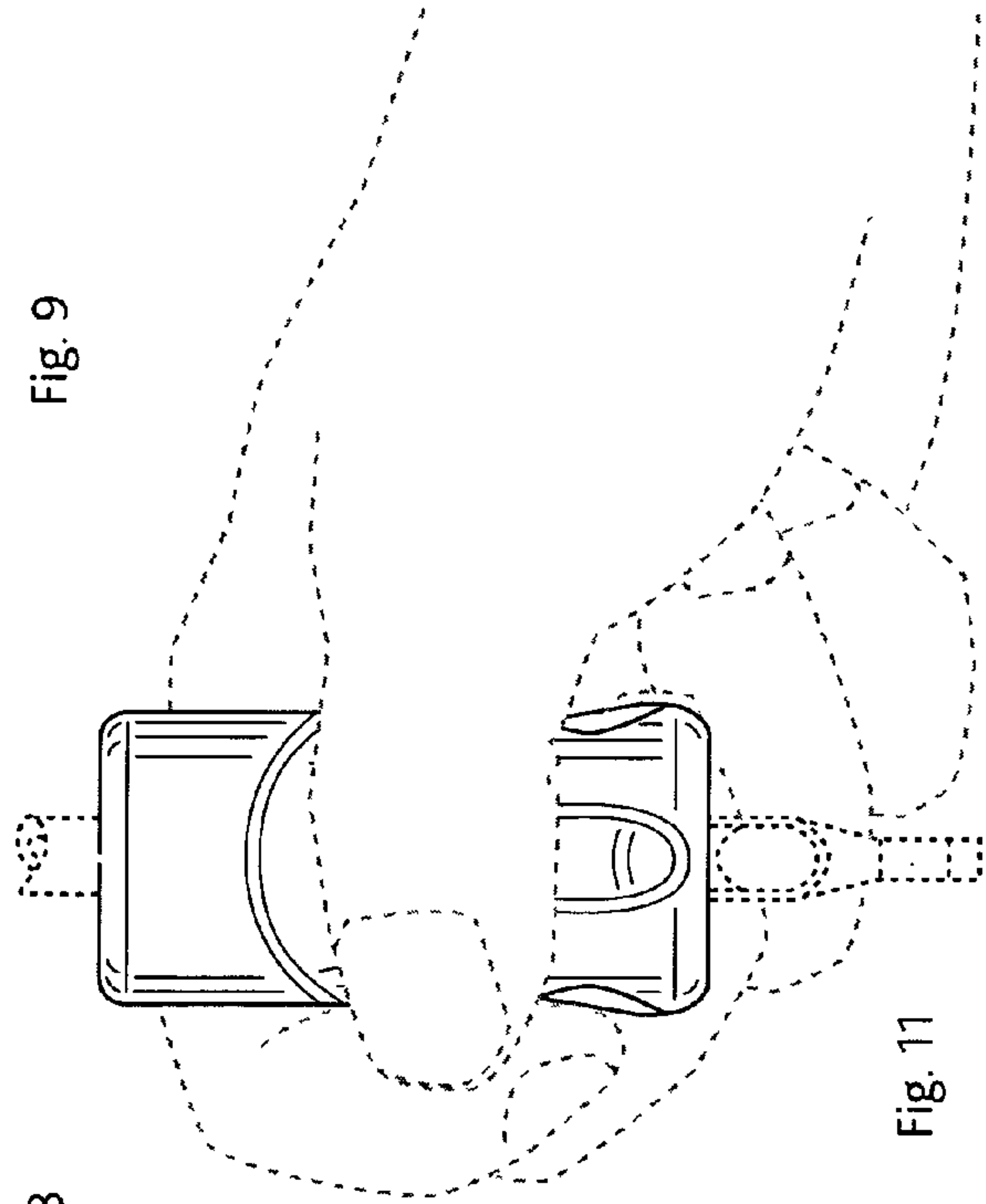

Fig. 11