



US00D609210S

(12) **United States Design Patent**
Sohn et al.

(10) **Patent No.:** **US D609,210 S**

(45) **Date of Patent:** **** Feb. 2, 2010**

(54) **MOBILE PHONE**

(75) Inventors: **Soo-Min Sohn**, Seoul (KR); **Joon-Suh Kim**, Anyang-Si (KR); **Chang-Hwan Hwang**, Goyang-Si (KR)

(73) Assignee: **Samsung Electronics Co., Ltd.**, Suwon-Si (KR)

(**) Term: **14 Years**

(21) Appl. No.: **29/333,261**

(22) Filed: **Mar. 5, 2009**

(30) **Foreign Application Priority Data**

Dec. 19, 2008 (KR) 30-2008-0054836

(51) **LOC (9) Cl.** **14-03**

(52) **U.S. Cl.** **D14/138 AD; D14/138 G**

(58) **Field of Classification Search** D14/138 R, D14/138 AD, 138 AC, 138 C, 138 G, 191, D14/203.1–203.8, 496, 138 AA, 138 AB, D14/247–248, 137, 147, 218, 341–347; D10/65, D10/78, 104; D13/168; D18/7; 455/566, 455/575.1, 575.3

See application file for complete search history.

(56) **References Cited**

U.S. PATENT DOCUMENTS

- D498,754 S * 11/2004 Blyth D14/341
- D511,342 S * 11/2005 Chien D14/346
- D544,459 S * 6/2007 Wang D14/138 AD
- D545,289 S * 6/2007 Wang D14/138 AD
- D547,296 S * 7/2007 Lin D14/138 AD
- D548,713 S * 8/2007 Lee et al. D14/138 AD
- D549,205 S * 8/2007 Cho D14/138 AD
- D555,134 S * 11/2007 Sung et al. D14/138 AC
- D558,720 S * 1/2008 Lee et al. D14/138 AD
- D560,193 S * 1/2008 Sung et al. D14/138 AD
- 7,372,413 B2 * 5/2008 Chang 343/702
- D572,695 S * 7/2008 Tu D14/138 AD
- D580,430 S * 11/2008 Wei D14/341

- D581,385 S * 11/2008 Park et al. D14/138 AD
- D584,274 S * 1/2009 Kim et al. D14/138 AD
- D584,709 S * 1/2009 Chiang D14/138 AD
- D585,411 S * 1/2009 Eaton D14/138 G

(Continued)

OTHER PUBLICATIONS

HTC Touch, announced Jun. 2007, [online], [retrieved on Aug. 6, 2007]. Retrieved from Internet ,<URL: <http://www.gsmarena.com>>.*

LG GM310, announced Feb. 2009, [online], [retrieved on Feb. 20, 2009]. Retrieved from Internet ,<URL: <http://www.gsmarena.com>>.*

(Continued)

Primary Examiner—Jeffrey D Asch

Assistant Examiner—Bridget L Eland

(74) *Attorney, Agent, or Firm*—Staas & Halsey LLP

(57) **CLAIM**

The ornamental design for mobile phone, as shown and described.

DESCRIPTION

FIG. 1 is a front perspective view of a mobile phone;
 FIG. 2 is a front view of the mobile phone of FIG. 1;
 FIG. 3 is a rear view of the mobile phone of FIG. 1;
 FIG. 4 is a left-side view of the mobile phone of FIG. 1;
 FIG. 5 is a right-side view of the mobile phone of FIG. 1;
 FIG. 6 is a top plan view of the mobile phone of FIG. 1;
 FIG. 7 is a bottom plan view of the mobile phone of FIG. 1;
 and,
 FIG. 8 is a front panel slid-up open view of the mobile phone of FIG. 1.

1 Claim, 6 Drawing Sheets

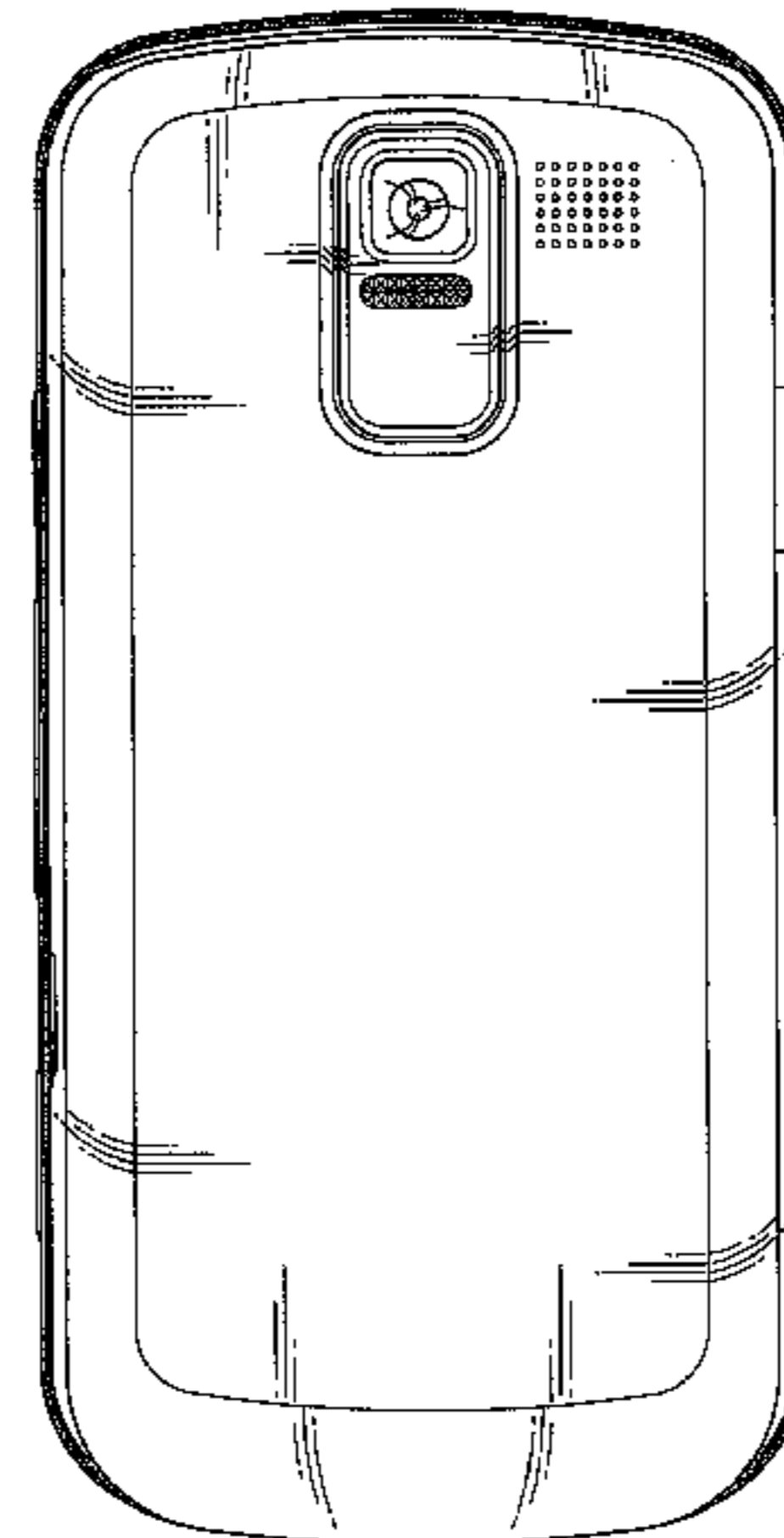
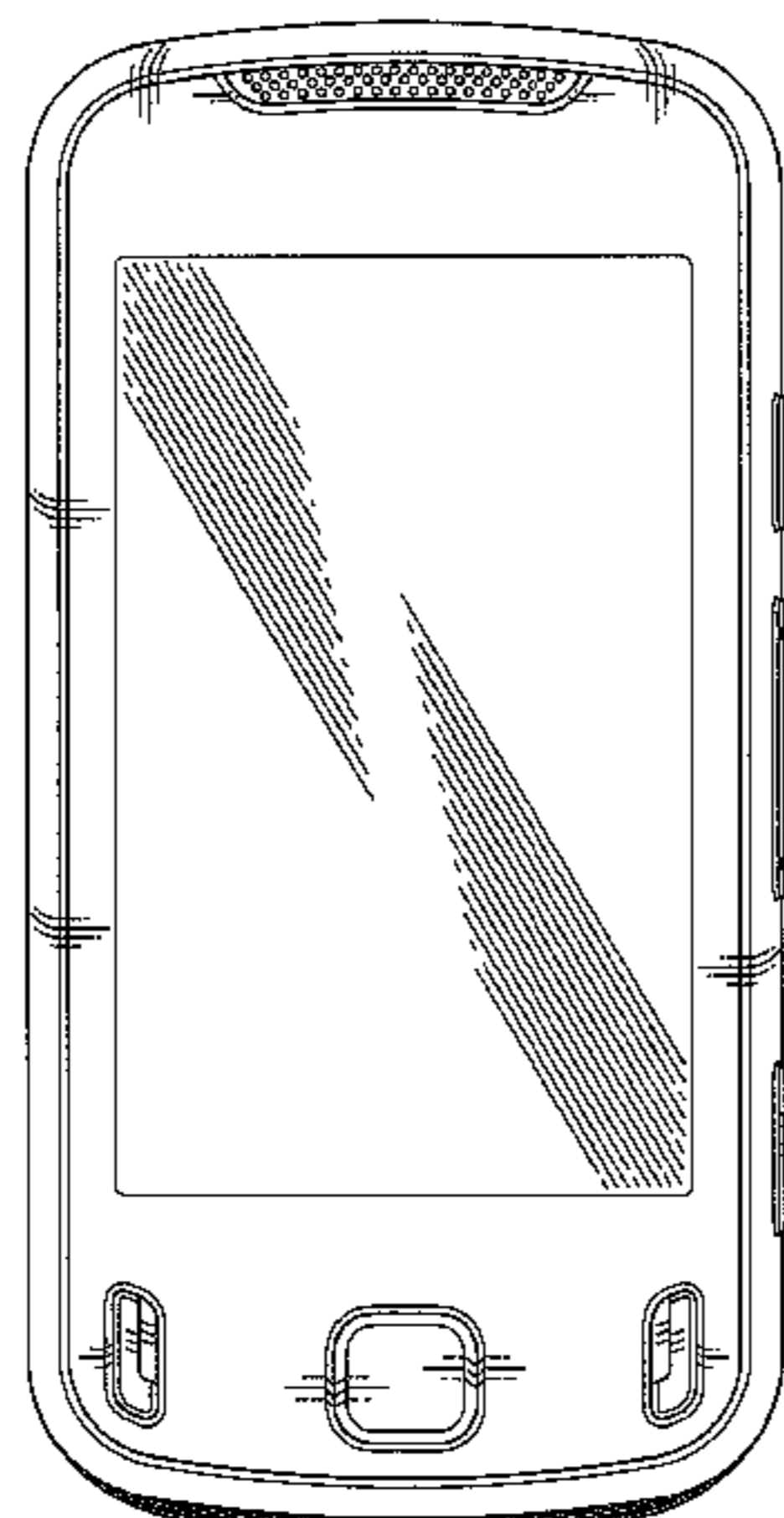

US D609,210 S

Page 2

U.S. PATENT DOCUMENTS

D589,482 S * 3/2009 Lee et al. D14/138 AD
D590,793 S * 4/2009 Kim et al. D14/138 AD
D590,799 S * 4/2009 Laine D14/138 AD
2005/0190291 A1 * 9/2005 Kota et al. 348/376
2006/0205450 A1 * 9/2006 Amano et al. 455/575.4
2007/0161418 A1 * 7/2007 Chen et al. 455/575.4
2008/0014919 A1 * 1/2008 Kim et al. 455/425
2008/0064448 A1 * 3/2008 Huang 455/566
2009/0167715 A1 * 7/2009 Wang et al. 345/173

OTHER PUBLICATIONS

Qtek A9100, announced Mar. 2006, [online], [retrieved on Nov. 8, 2008]. Retrieved from Internet ,<URL: <http://www.gsmarena.com>>.*

Samsung F700, announced Feb. 2007, [online], [retrieved on Feb. 8, 2007]. Retrieved from Internet ,<URL: <http://www.gsmarena.com>>.*

Samsung T749 Highlight, announced Jun. 2009, [online], [retrieved on Jul. 20, 2009]. Retrieved from Internet ,<URL: <http://www.gsmarena.com>>.*

* cited by examiner

FIG. 1

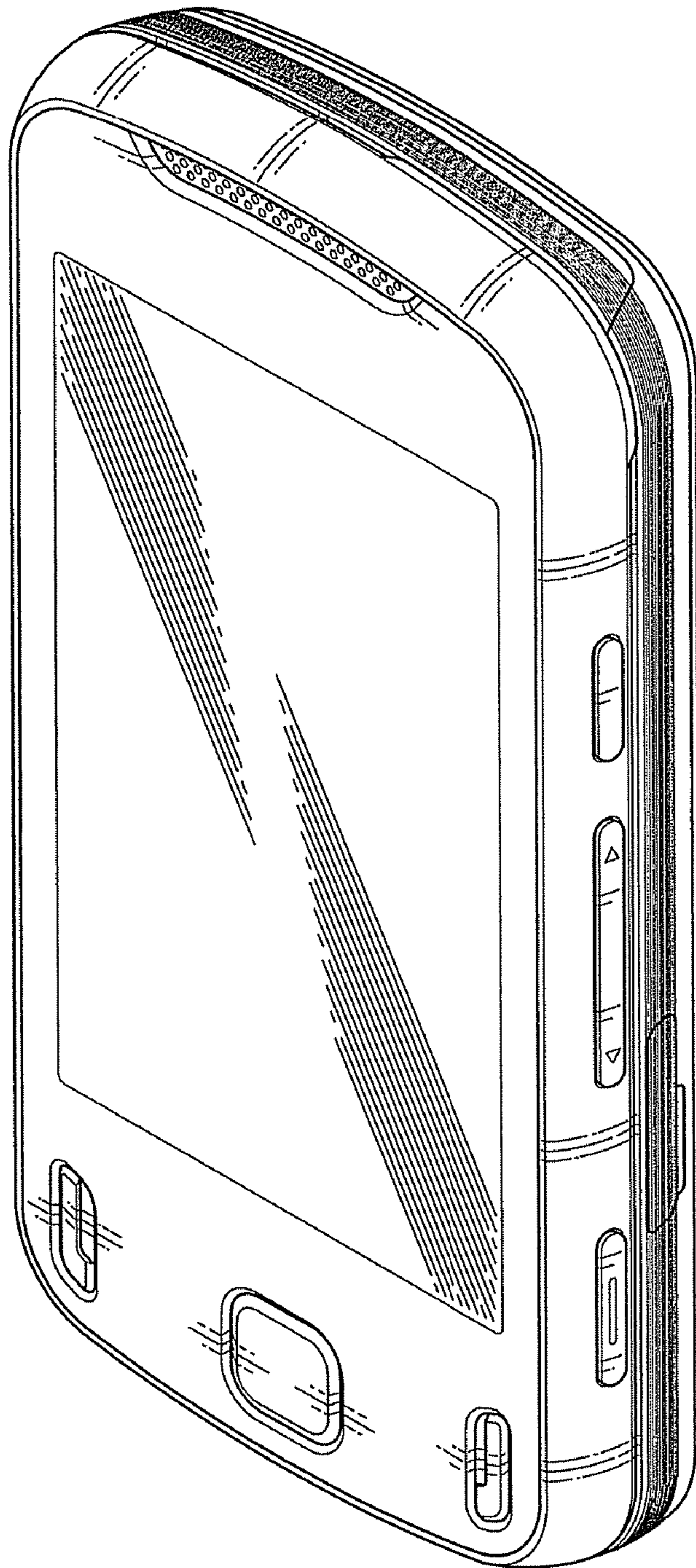

FIG. 2

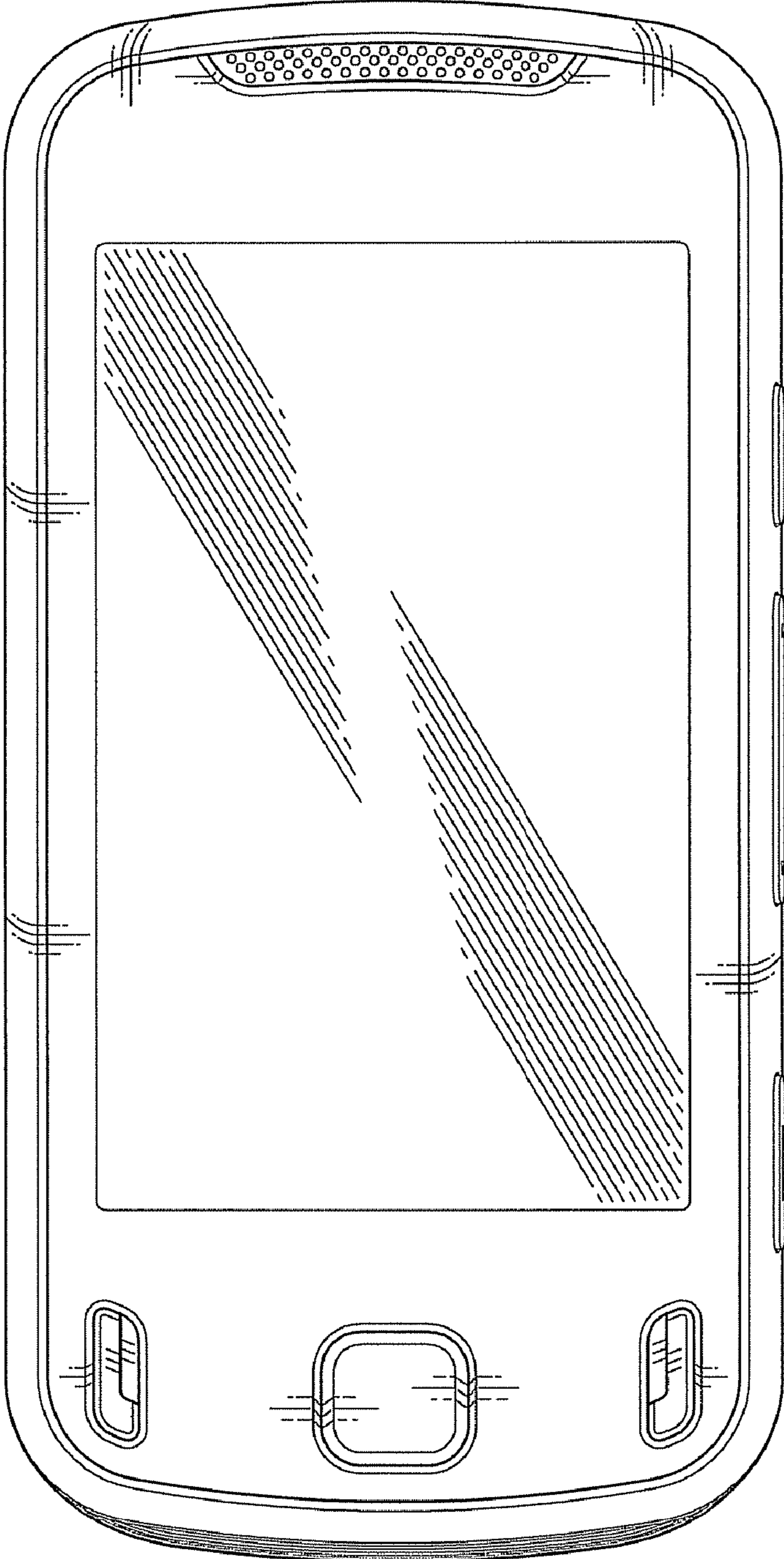

FIG. 3

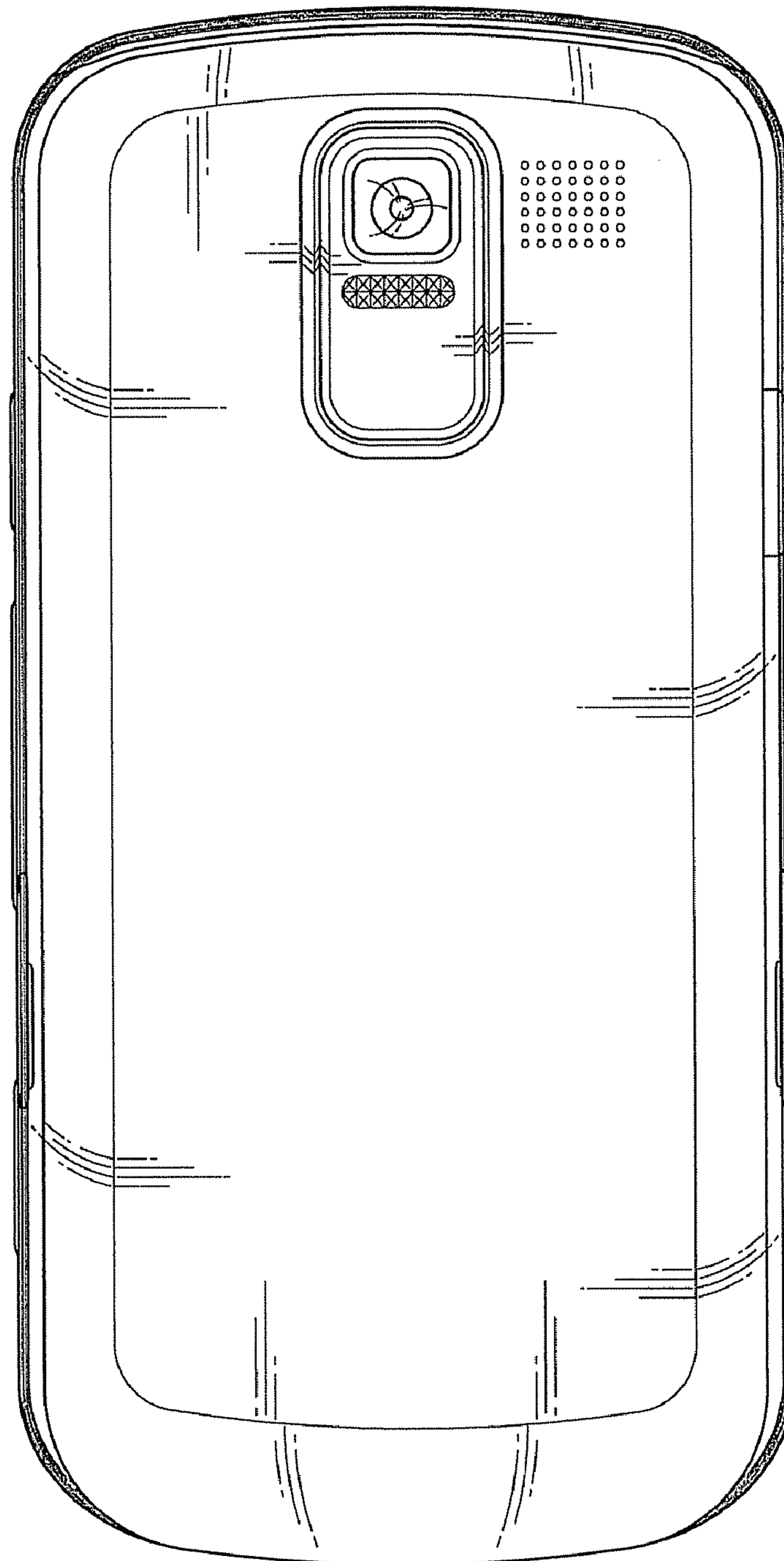

FIG. 4

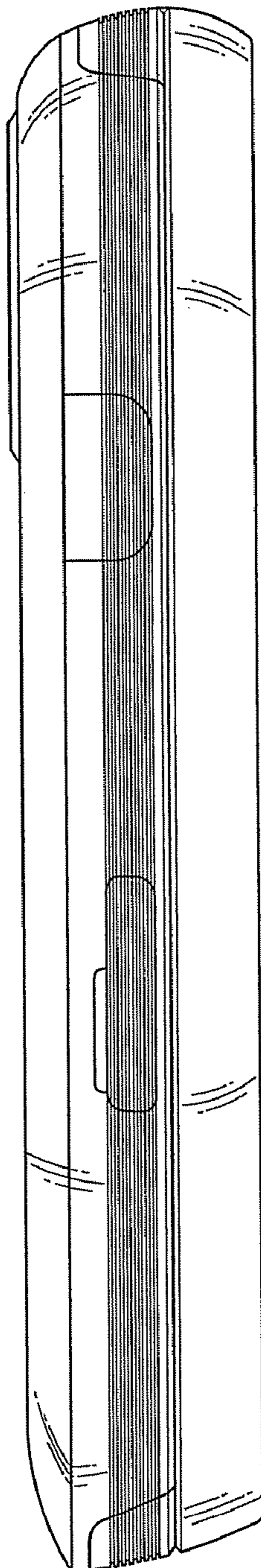

FIG. 5

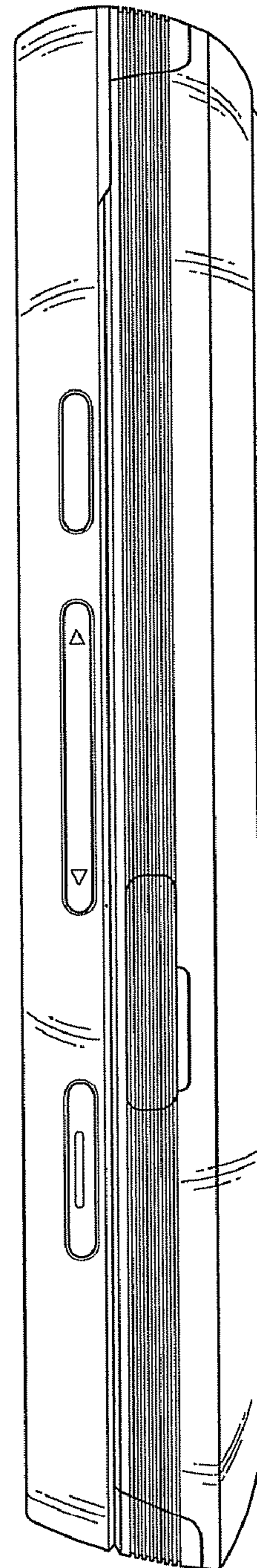

FIG. 6

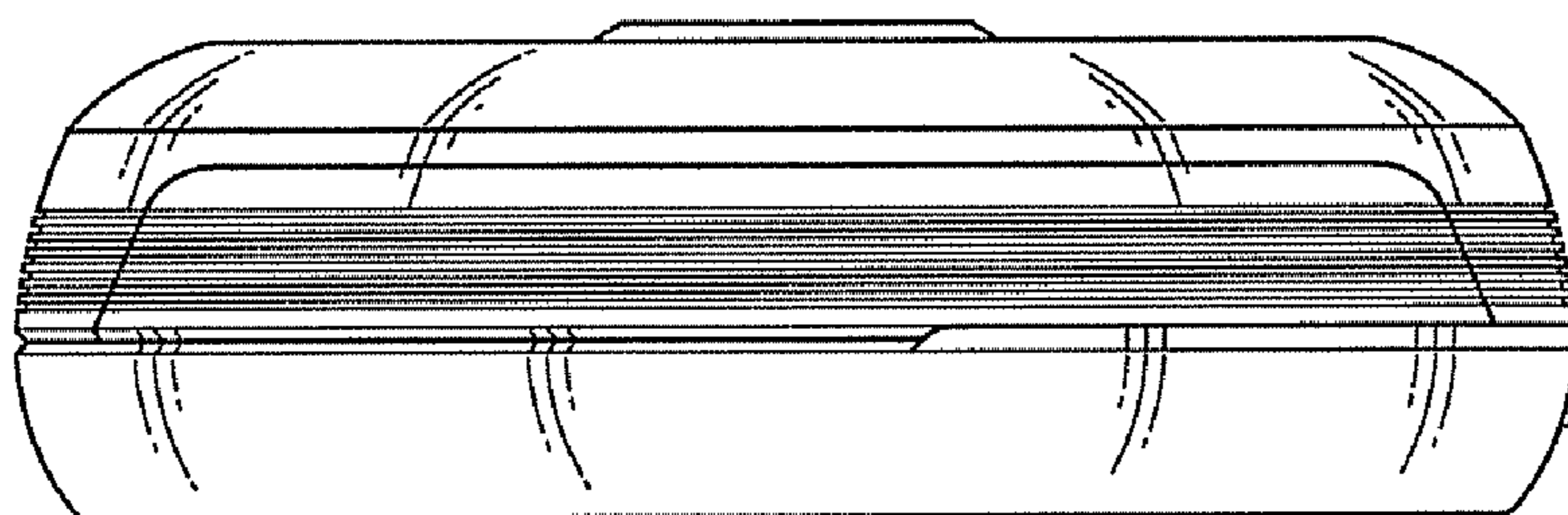

FIG. 7

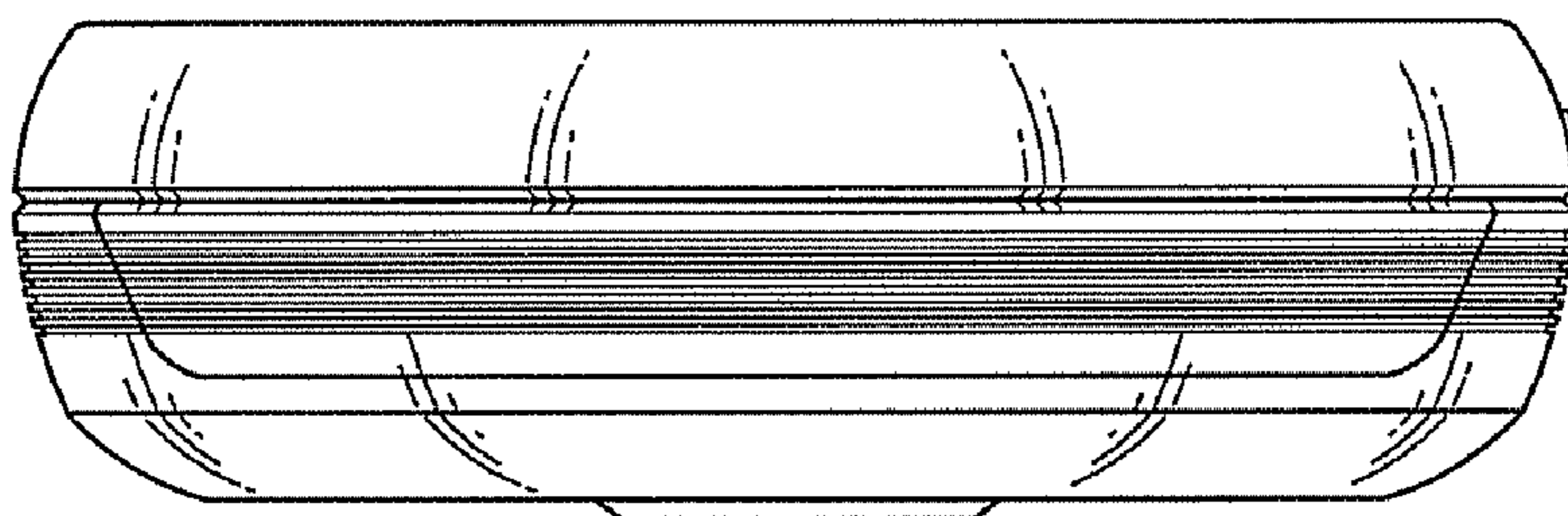

FIG. 8

