



US00D609149S

(12) **United States Design Patent**
Larson et al.

(10) **Patent No.:** **US D609,149 S**
(45) **Date of Patent:** **** Feb. 2, 2010**

(54) **AIR INTAKE GRILL**

D447,451 S * 9/2001 Im D12/163
D586,273 S * 2/2009 Hamburger D12/181
D598,345 S * 8/2009 Juraschek D12/181

(75) Inventors: **Grant Larson**, Ludwigsburg (DE);
Hakan Saracoglu, Stuttgart (DE)

(73) Assignee: **Dr. Ing. h.c. F. Porsche**
Aktiengesellschaft, Stuttgart (DE)

* cited by examiner

Primary Examiner—Caron Veynar
Assistant Examiner—Katrina A Kile

(**) Term: **14 Years**

(21) Appl. No.: **29/332,267**

(57) **CLAIM**

(22) Filed: **Feb. 12, 2009**

The ornamental design for an air intake grill, as shown and described.

(30) **Foreign Application Priority Data**

DESCRIPTION

Aug. 12, 2008 (DE) 40 2008 003 801

(51) **LOC (9) Cl.** **12-08**

(52) **U.S. Cl.** **D12/181**

(58) **Field of Classification Search** D12/181,
D12/191, 196, 400, 190, 88; 280/727, 770,
280/848; 296/190.1–190.5, 91; 180/903
See application file for complete search history.

FIG. 1 is a front view of the air intake grill showing my new design;
FIG. 2 is a front, perspective view thereof;
FIG. 3 is a left-side view thereof;
FIG. 4 is right-side view thereof;
FIG. 5 is top view thereof;
FIG. 6 is a bottom view thereof; and,
FIG. 7 is a rear view thereof.

(56) **References Cited**

U.S. PATENT DOCUMENTS

D160,855 S * 11/1950 Goldtine et al. D12/181

1 Claim, 4 Drawing Sheets

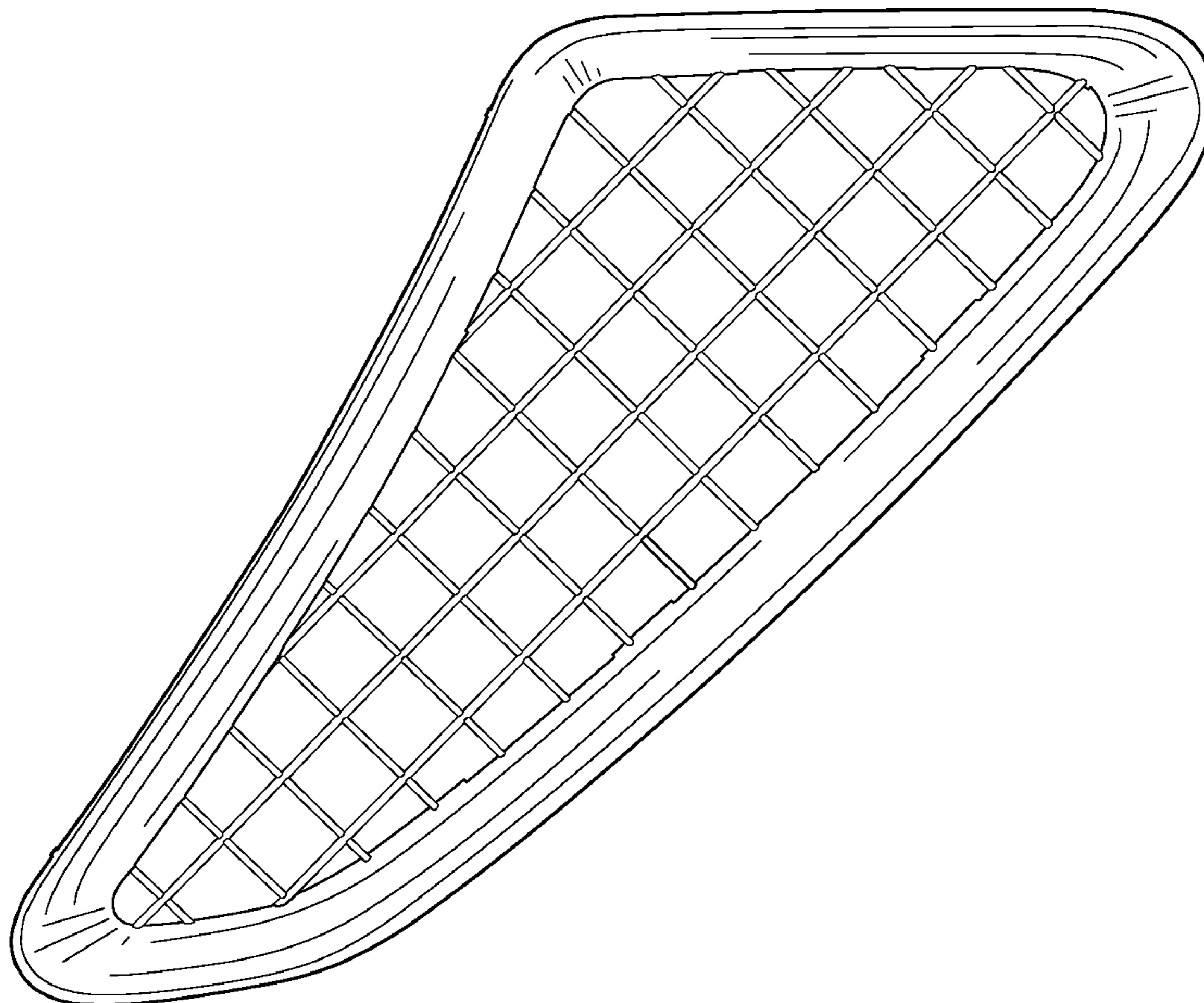

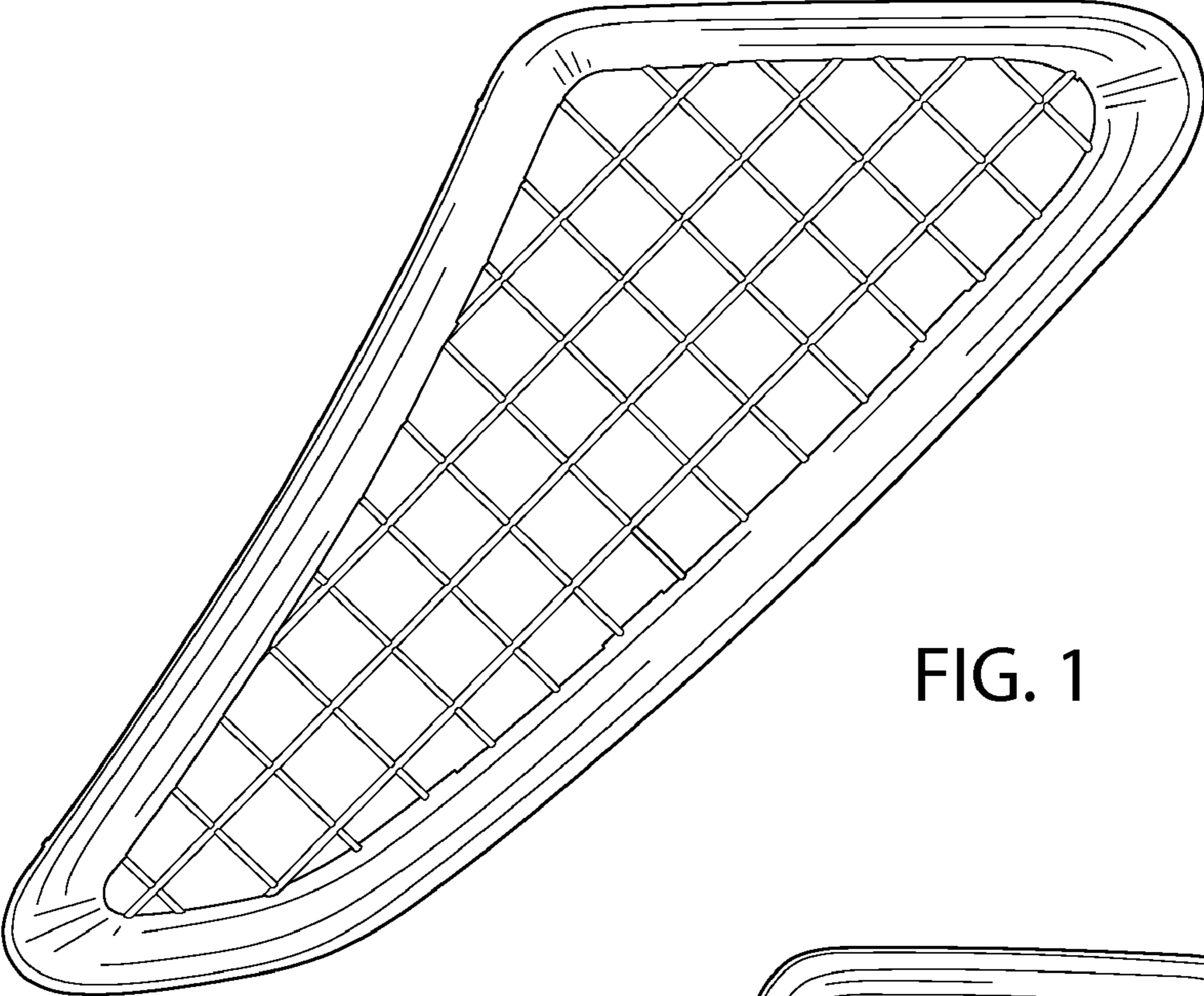

FIG. 1

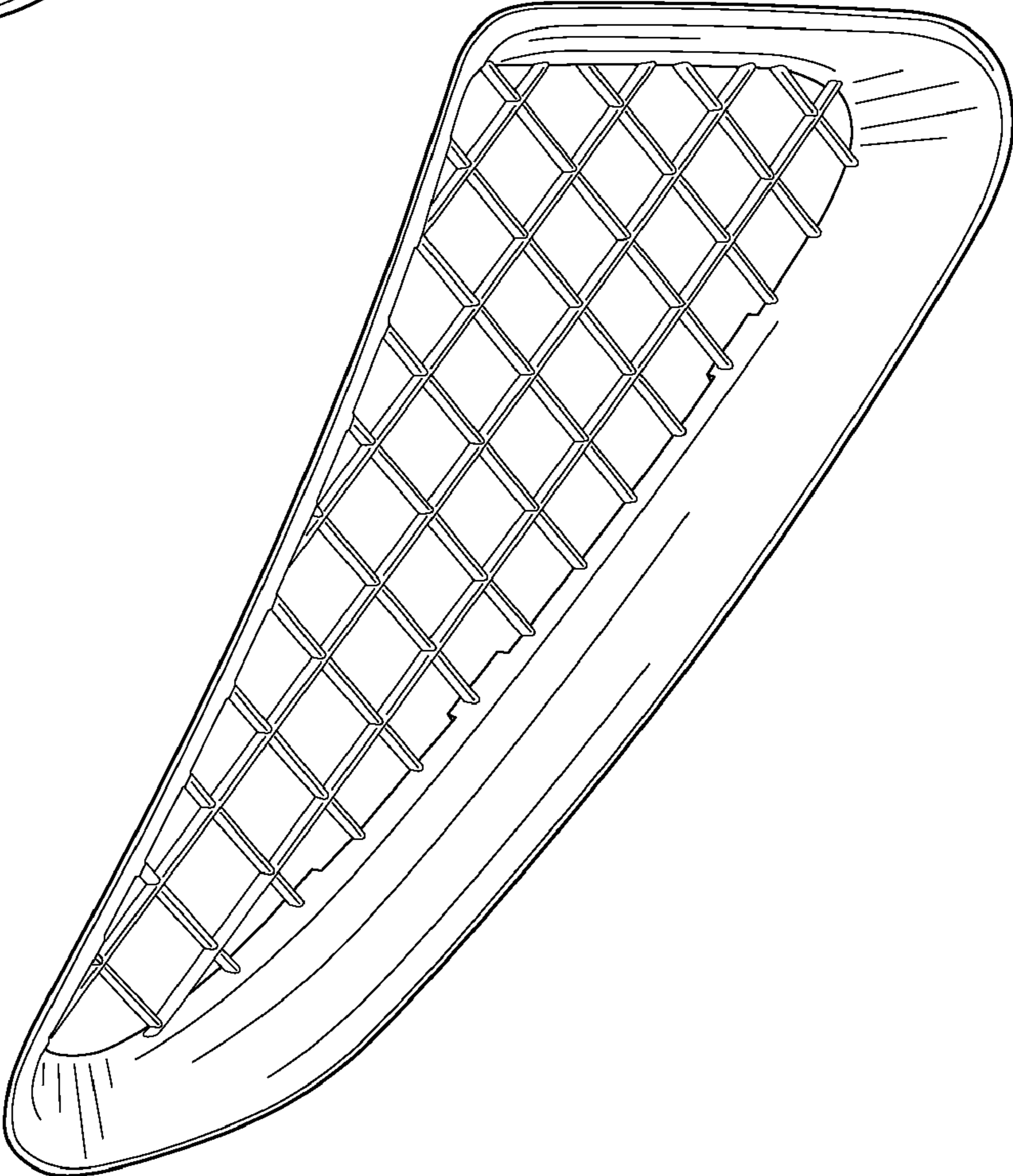

FIG. 2

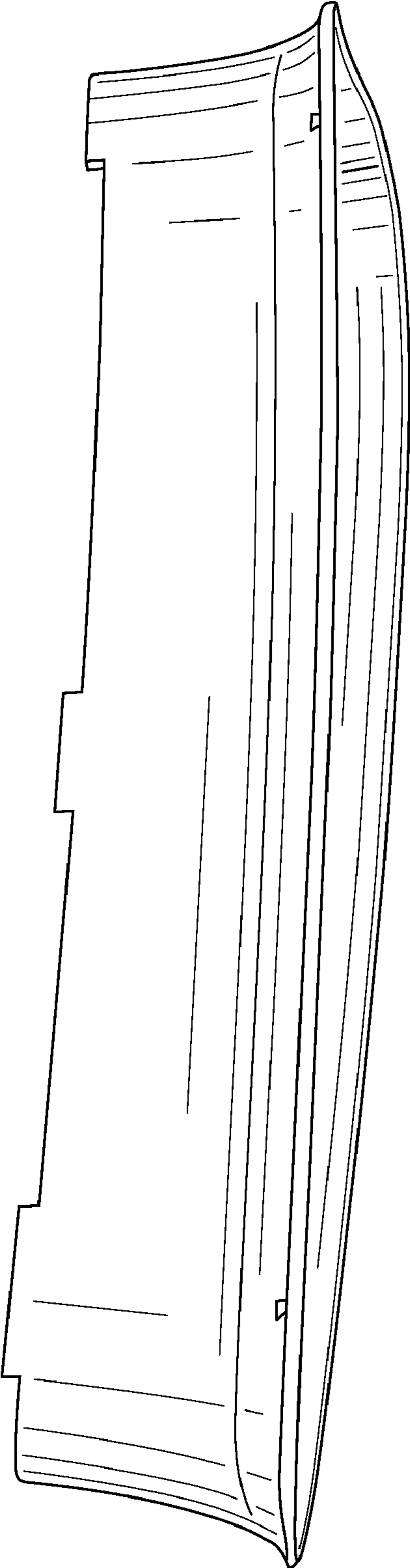

FIG. 3

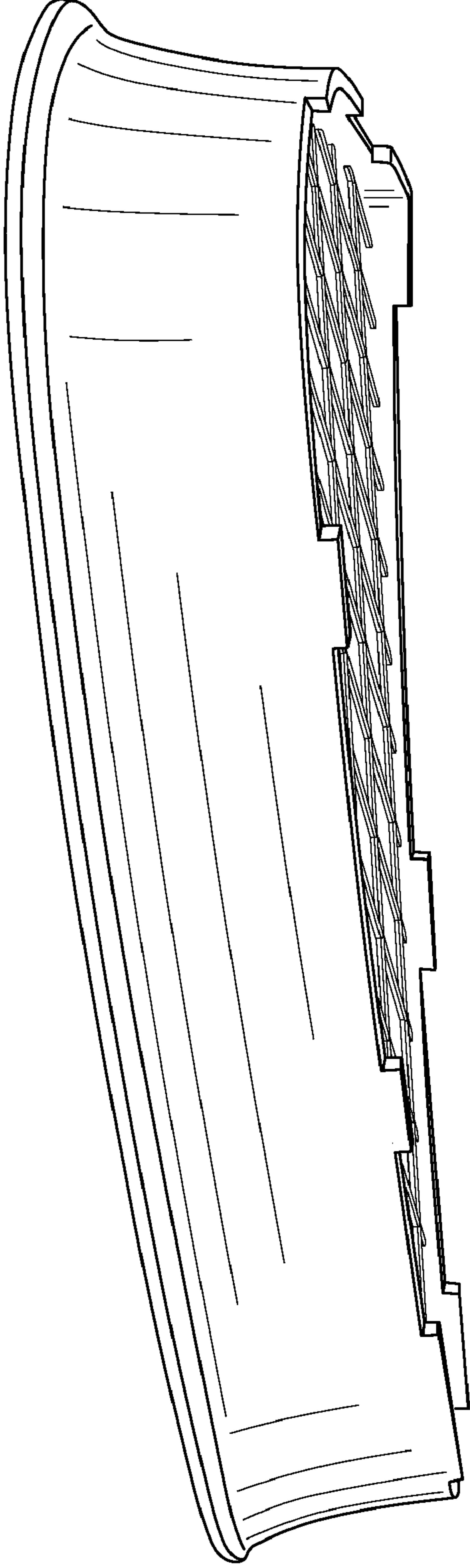

FIG. 4

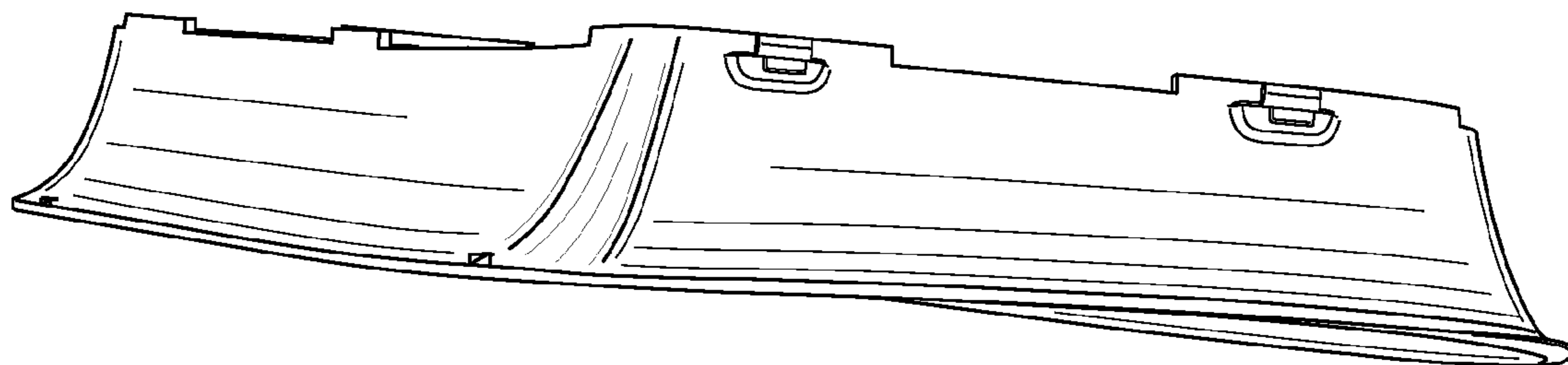

FIG. 5

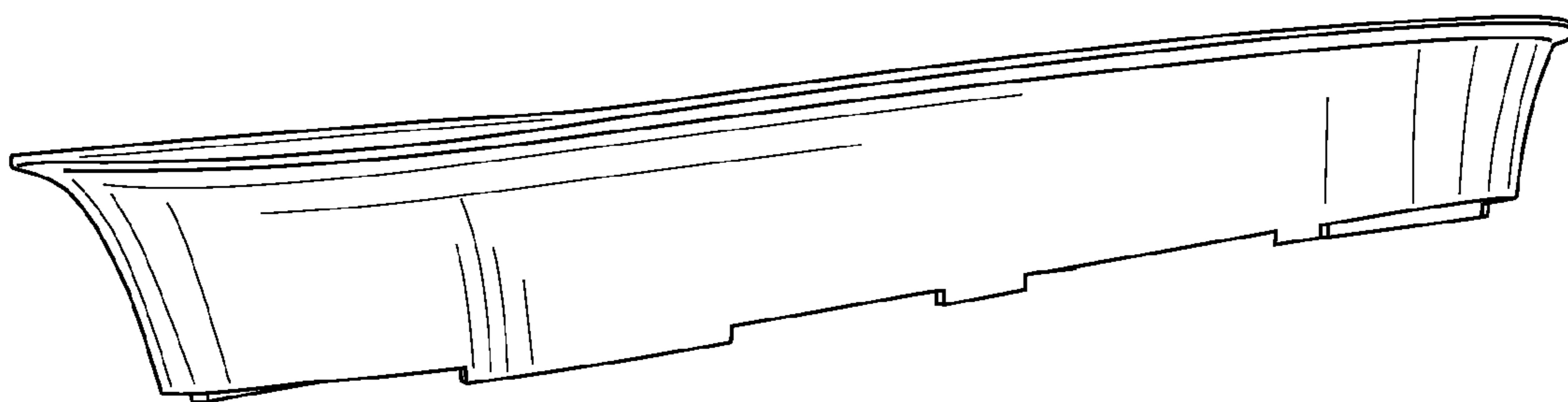

FIG. 6

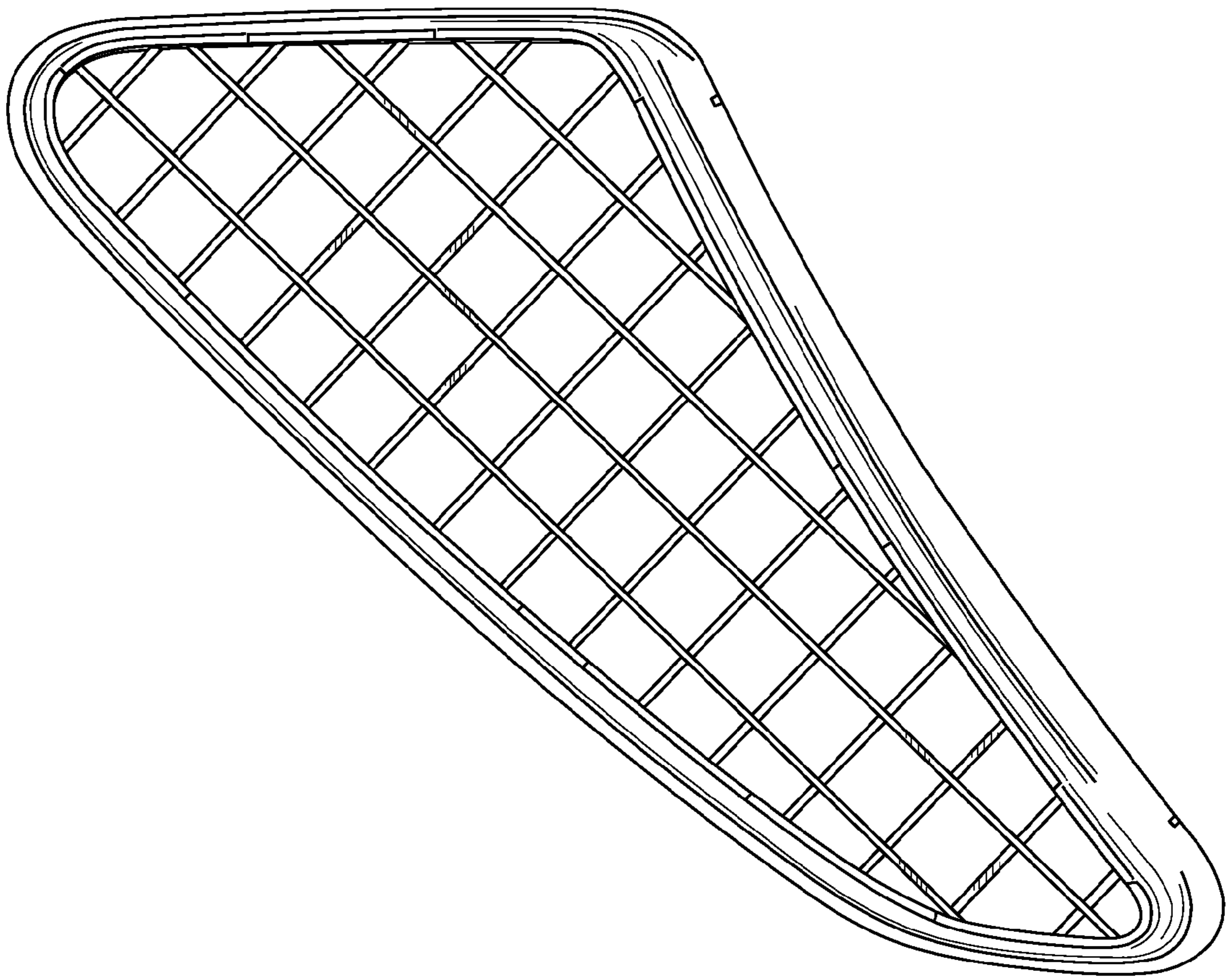

FIG. 7