



US00D609095S

(12) **United States Design Patent**
Kooser et al.

(10) **Patent No.:** **US D609,095 S**

(45) **Date of Patent:** **** Feb. 2, 2010**

(54) **CONTAINER**

(75) Inventors: **William J. Kooser**, Pittsburgh, PA (US);
Mark R. Prus, Pittsburgh, PA (US)

(73) Assignee: **SmithKline Beecham Corp.**,
Philadelphia, PA (US)

(**) Term: **14 Years**

(21) Appl. No.: **29/324,229**

(22) Filed: **Sep. 9, 2008**

(51) **LOC (9) Cl.** **09-01**

(52) **U.S. Cl.** **D9/504; D9/452; D9/537**

(58) **Field of Classification Search** D9/500,
D9/502-505, 516, 537-540, 549, 551, 557-558,
D9/415, 424, 435, 453-454; 215/379, 381-384;
220/660, 662, 669-673, 675

See application file for complete search history.

(56) **References Cited**

U.S. PATENT DOCUMENTS

D231,087 S *	4/1974	Edwards	D9/503
D381,906 S *	8/1997	Bartsch	D9/438
D390,466 S *	2/1998	Mao	D9/454
D456,265 S *	4/2002	Spear	D9/502
D475,923 S *	6/2003	Renz	D9/446
D529,380 S *	10/2006	Yelland	D9/447
D535,563 S *	1/2007	Martin	D9/500
D552,993 S *	10/2007	Rathbone et al.	D9/504
D569,253 S *	5/2008	Cracchiolo	D9/503
D588,936 S *	3/2009	Ioannides et al.	D9/776
D593,414 S *	6/2009	Hunter	D9/520
D596,032 S *	7/2009	Shin et al.	D9/504
D596,035 S *	7/2009	Shin et al.	D9/529

* cited by examiner

Primary Examiner—Ian Simmons

Assistant Examiner—Dana L Sipos

(74) *Attorney, Agent, or Firm*—Dara L. Dinner; Theodore R. Furman

(57) **CLAIM**

The ornamental design for a container, as shown and described.

DESCRIPTION

FIG. 1 is a top, front, right side perspective view of a container showing my new design;

FIG. 2 is a right side elevation view thereof;

FIG. 3 is a left side elevation view thereof;

FIG. 4 is a front elevation view thereof;

FIG. 5 is a rear elevation view thereof;

FIG. 6 is a top plan view thereof;

FIG. 7 is a bottom plan view thereof;

FIG. 8 is an exploded top, perspective view of the container of FIG. 1 shown in the open position;

FIG. 9 is a rear elevation view thereof, shown with the closure portion removed;

FIG. 10 is a front elevation view thereof;

FIG. 11 is a right side elevation view thereof;

FIG. 12 is a left side elevation view thereof;

FIG. 13 is a top plan view thereof; and,

FIG. 14 is a bottom plan view thereof.

The dot-dash broken lines in FIGS. 7 & 14 define the bounds of the claim and form no part thereof. The evenly dashed broken lines in the drawing views illustrate details of the design that form no part of the claim.

1 Claim, 12 Drawing Sheets

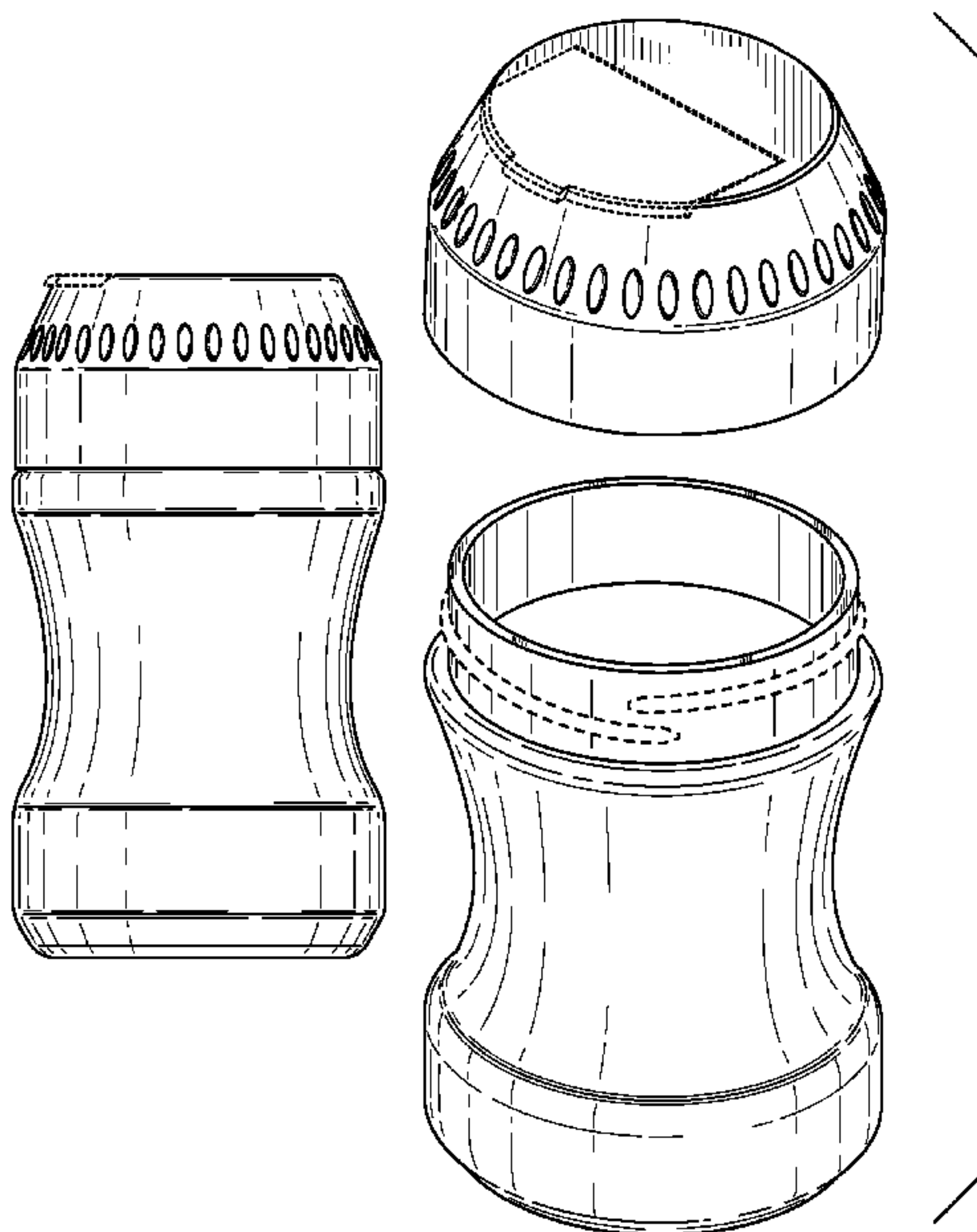

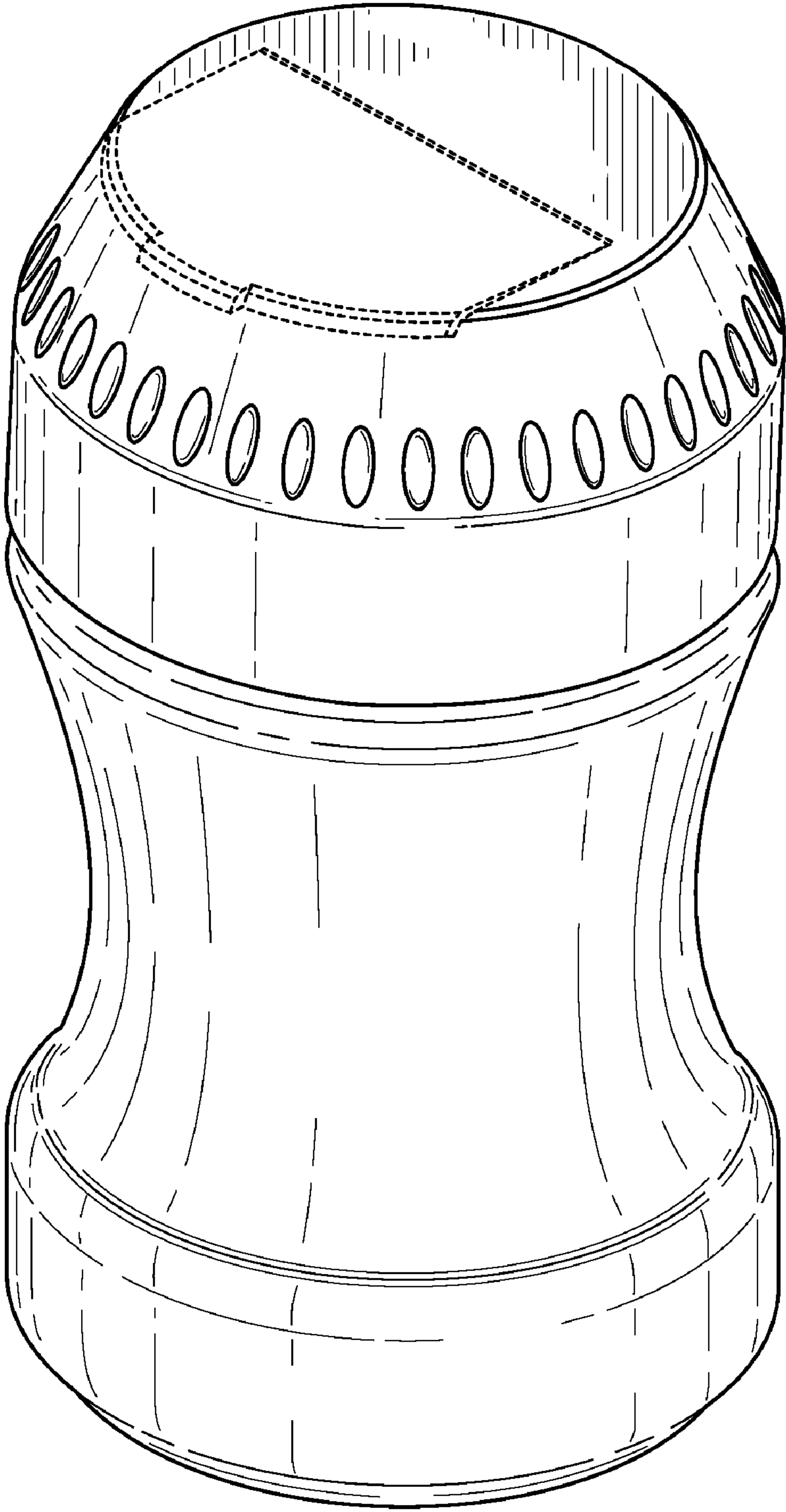

FIG. 1

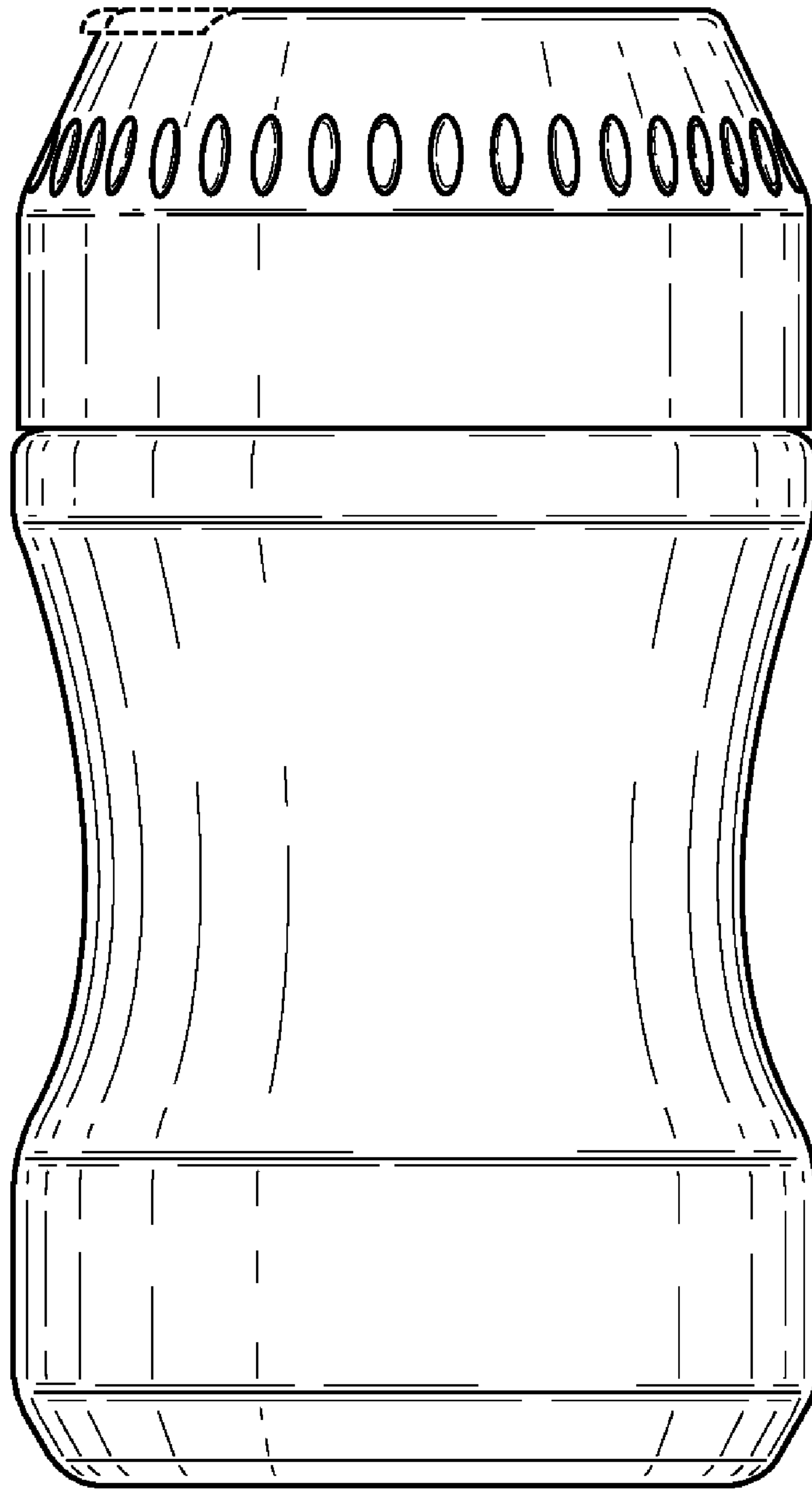

FIG. 2

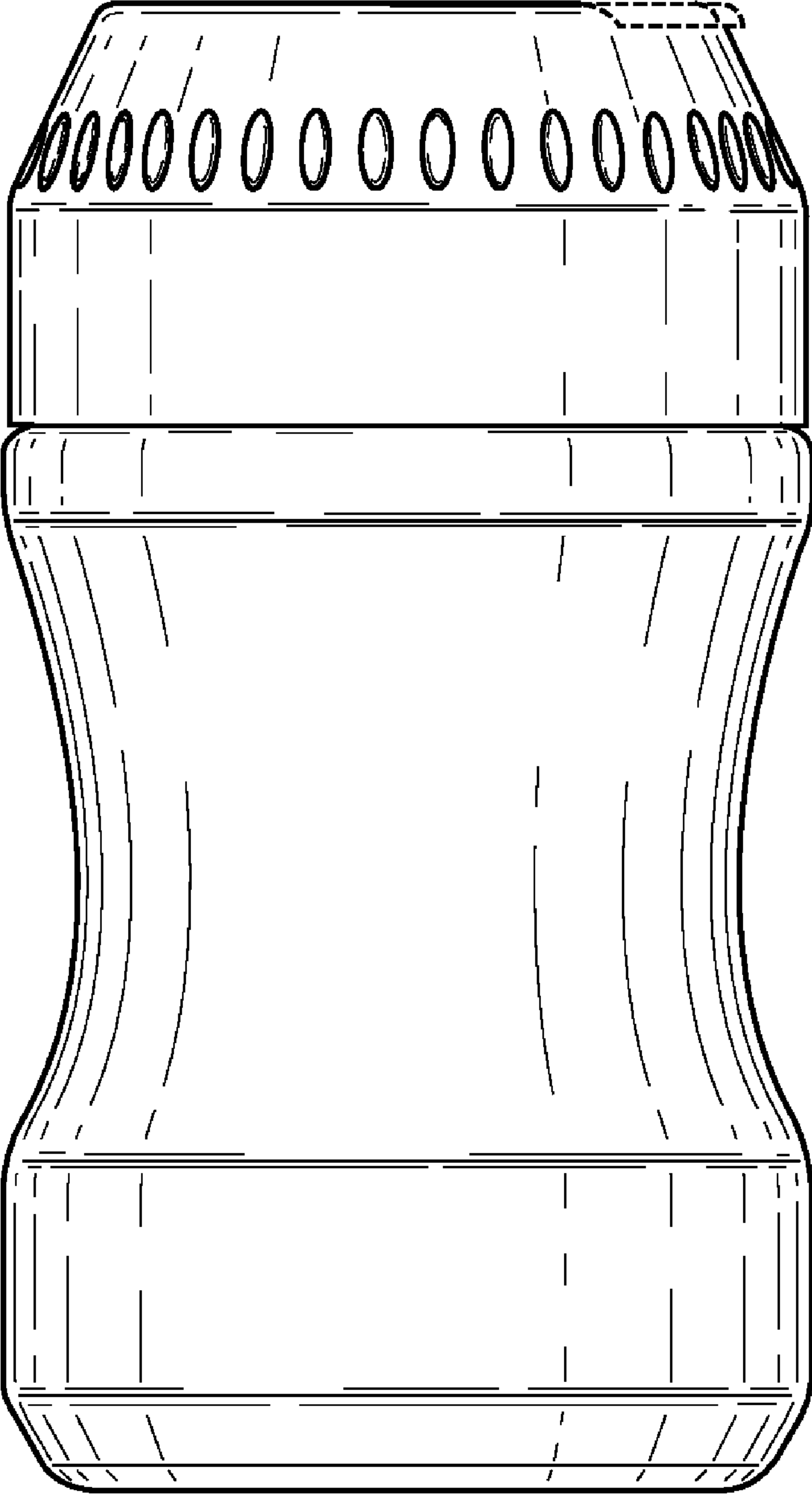

FIG. 3

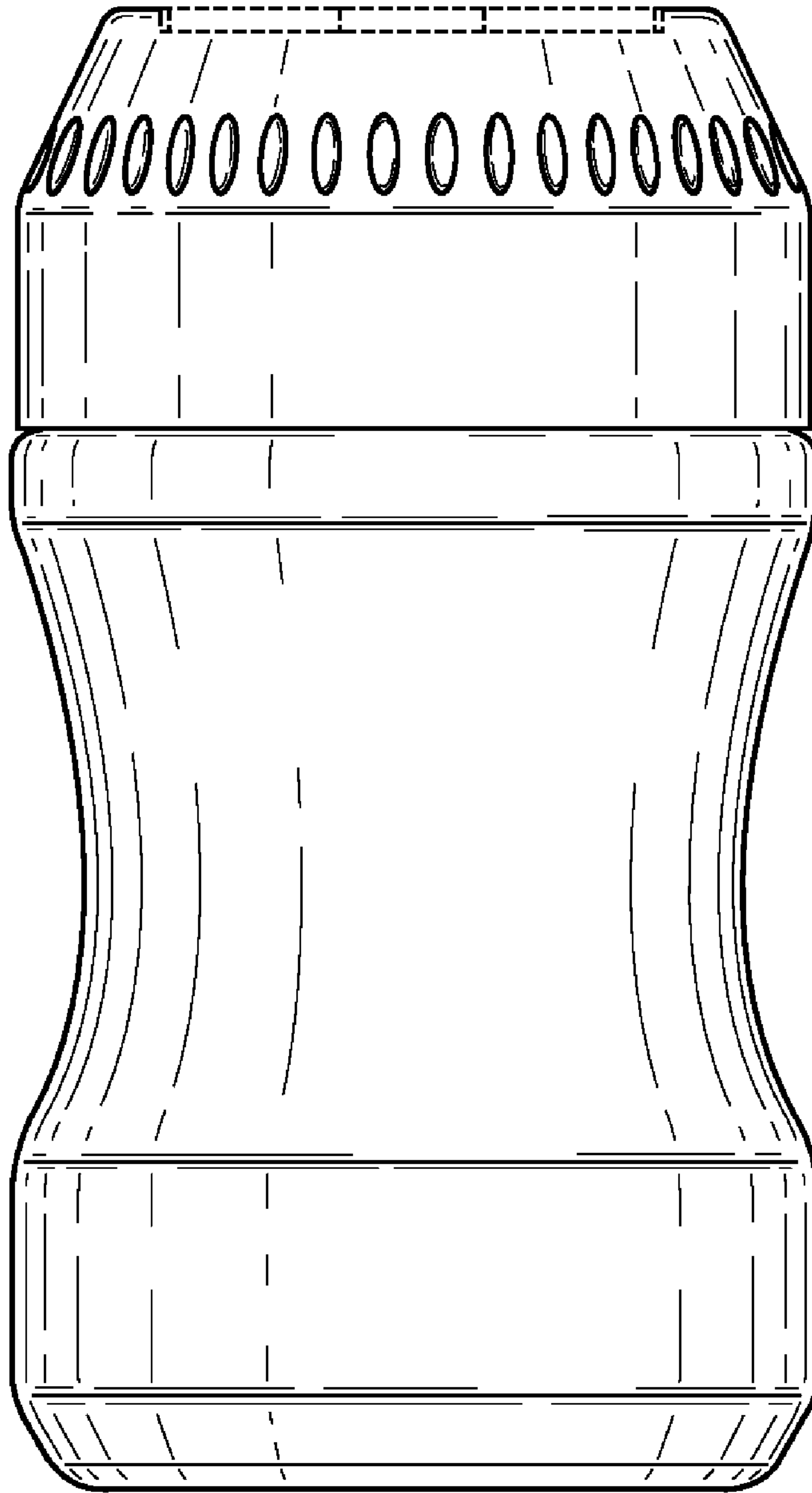

FIG. 4

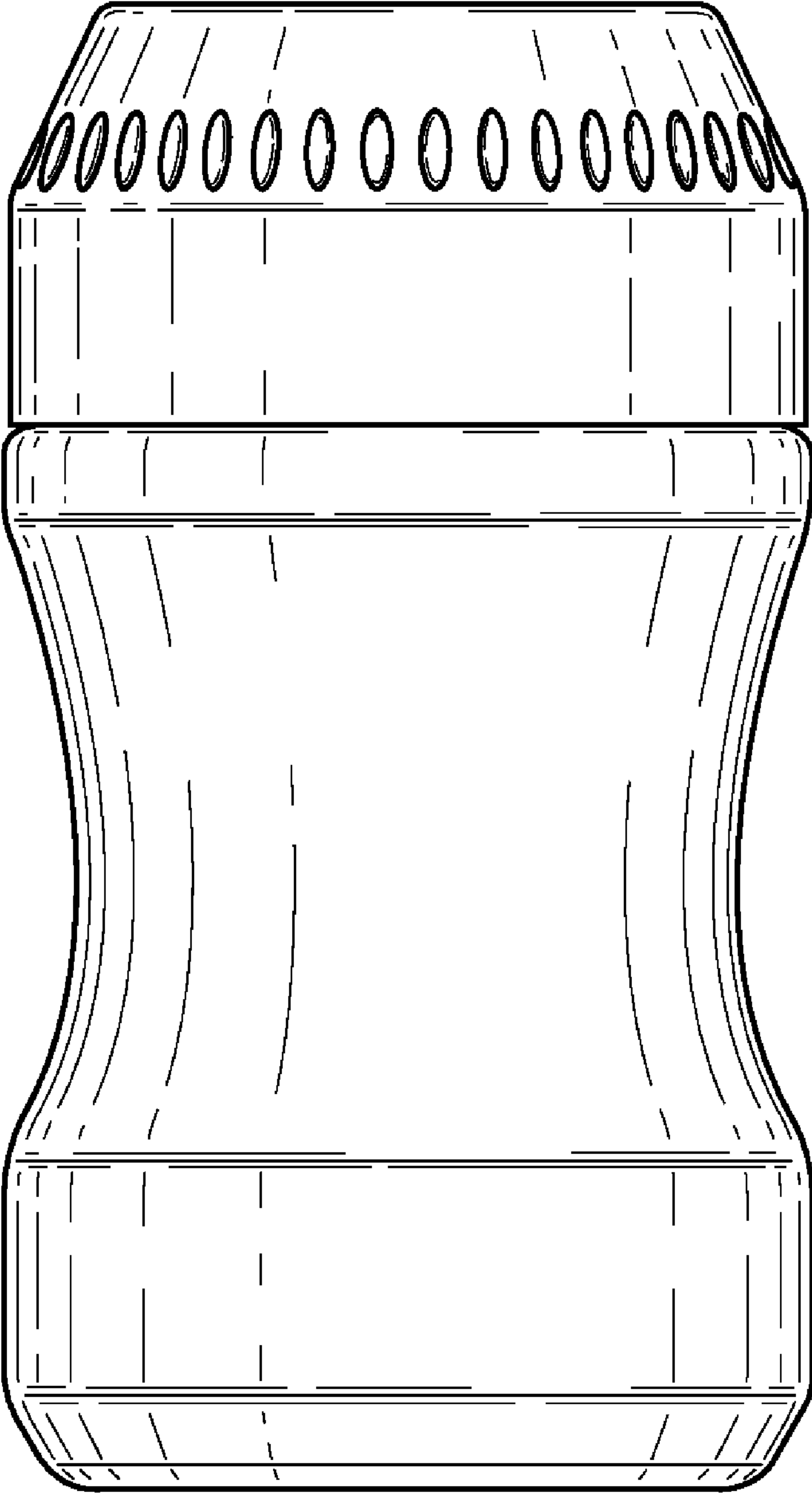

FIG. 5

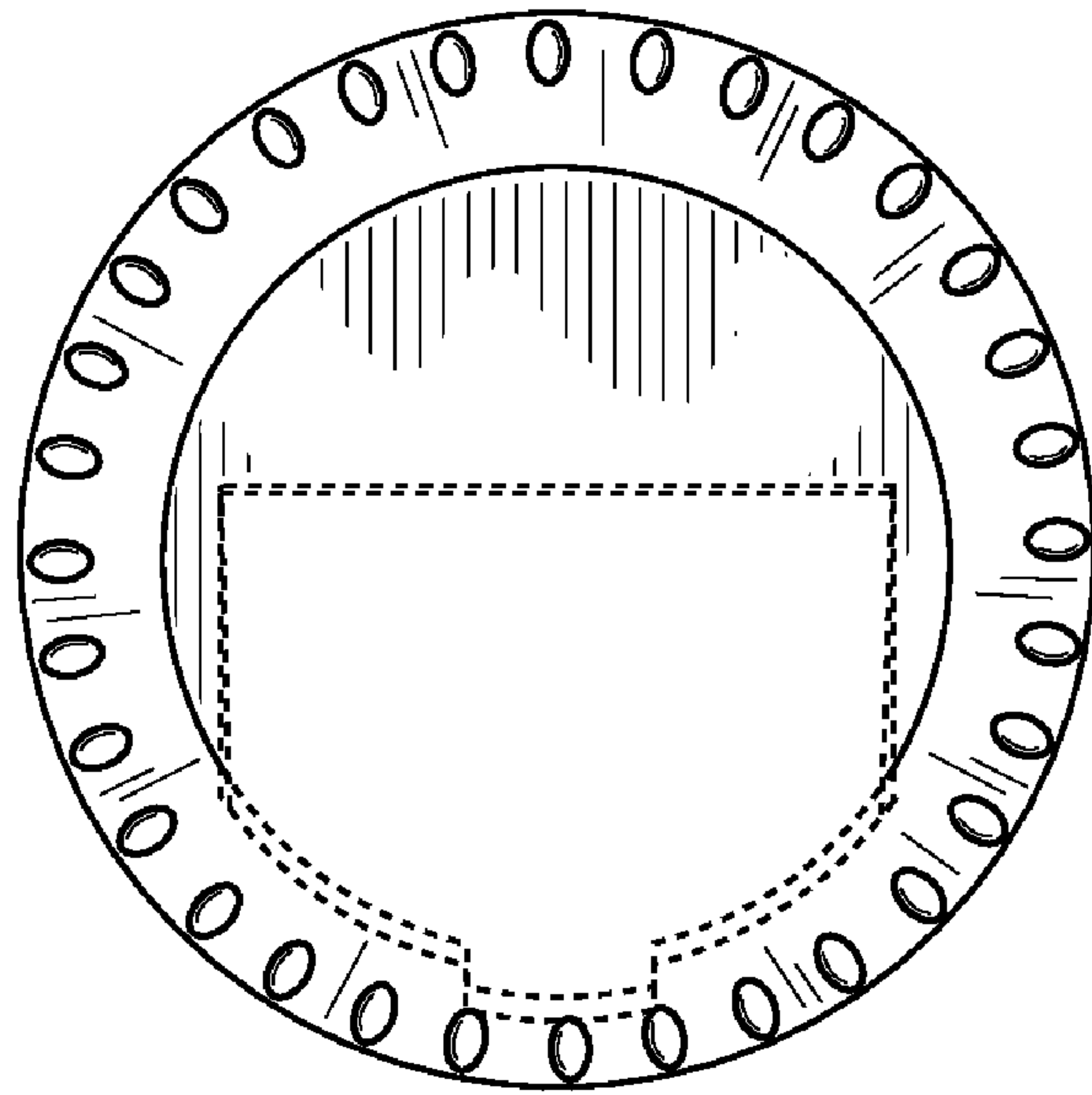

FIG. 6

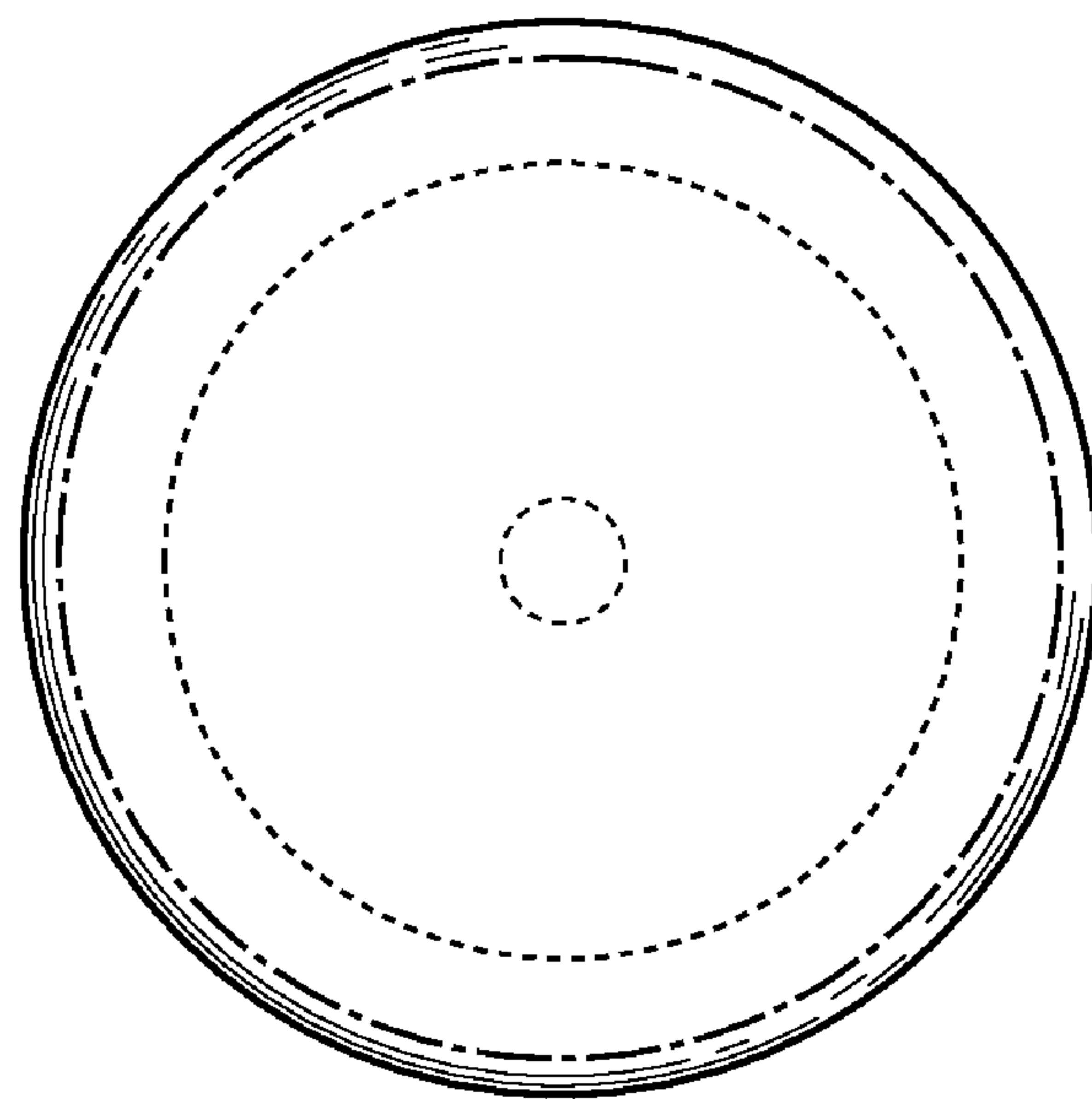

FIG. 7

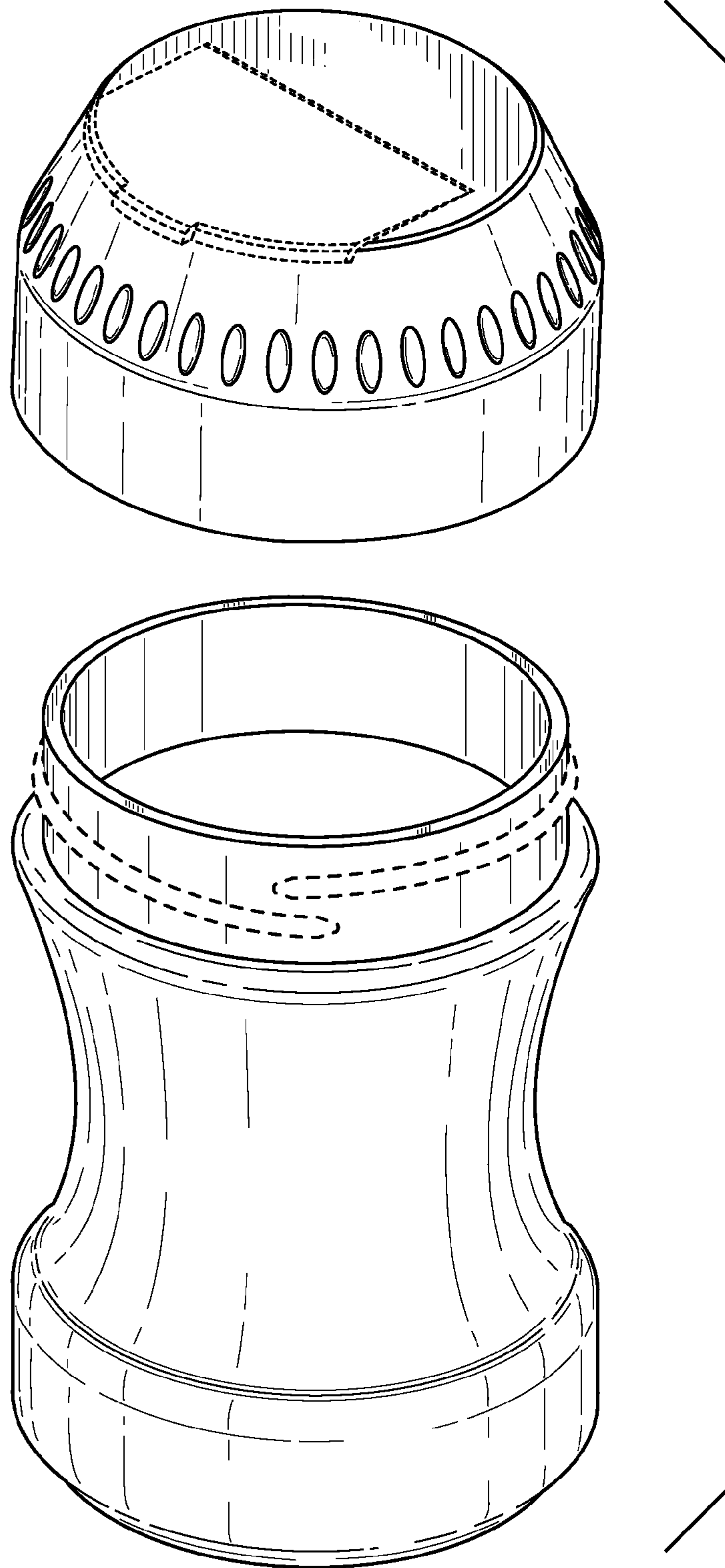

FIG. 8

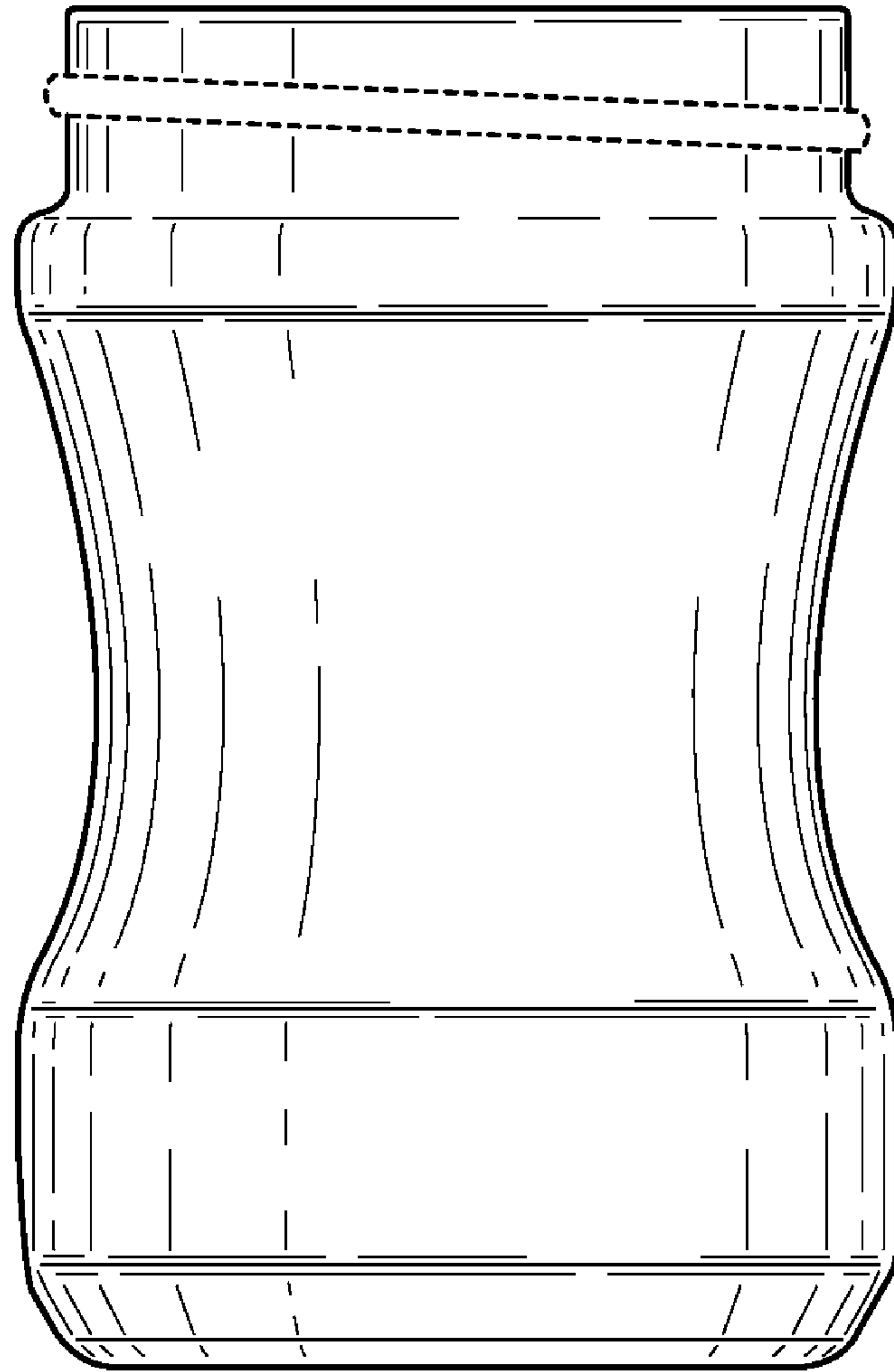

FIG. 9

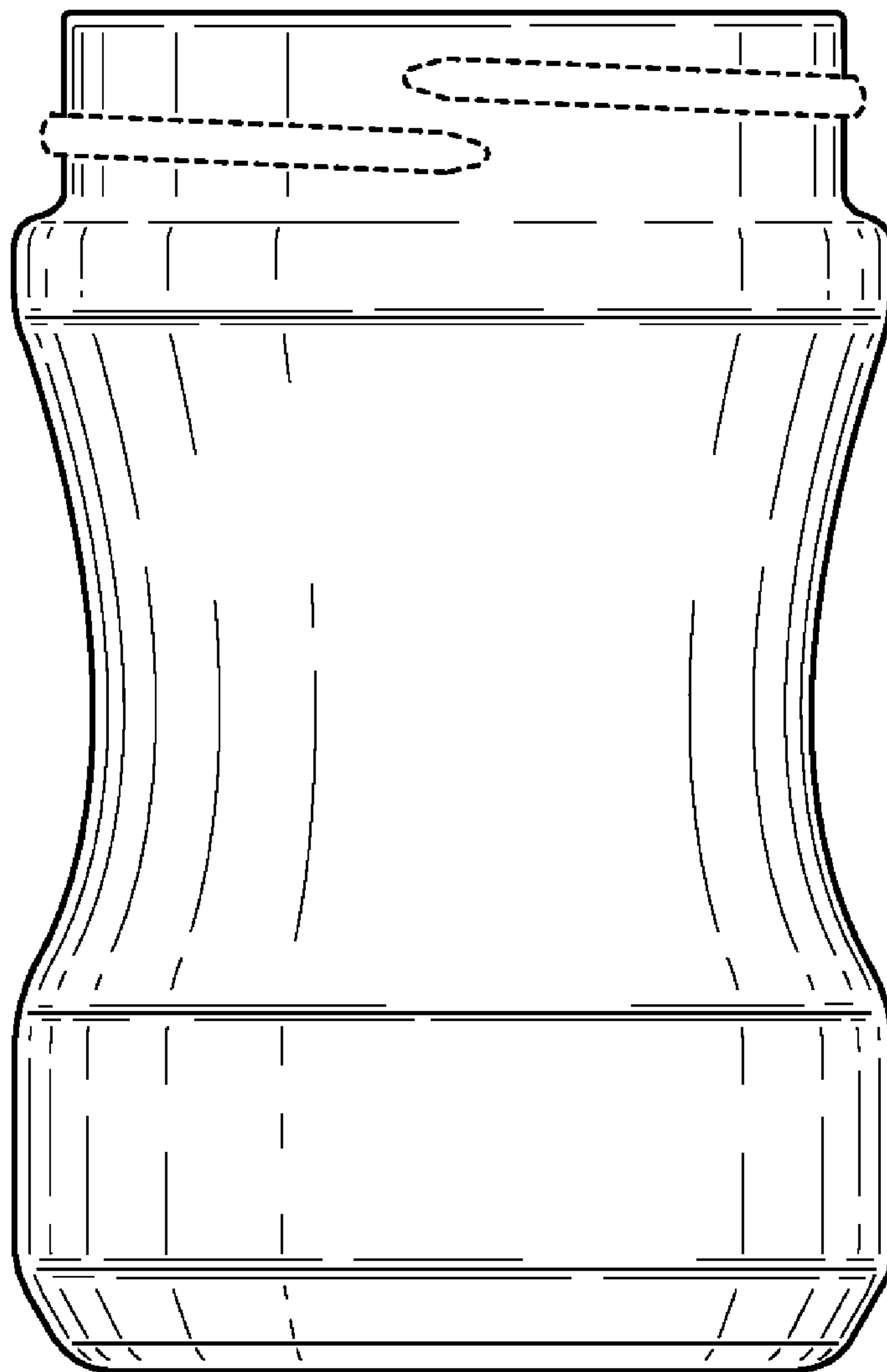

FIG. 10

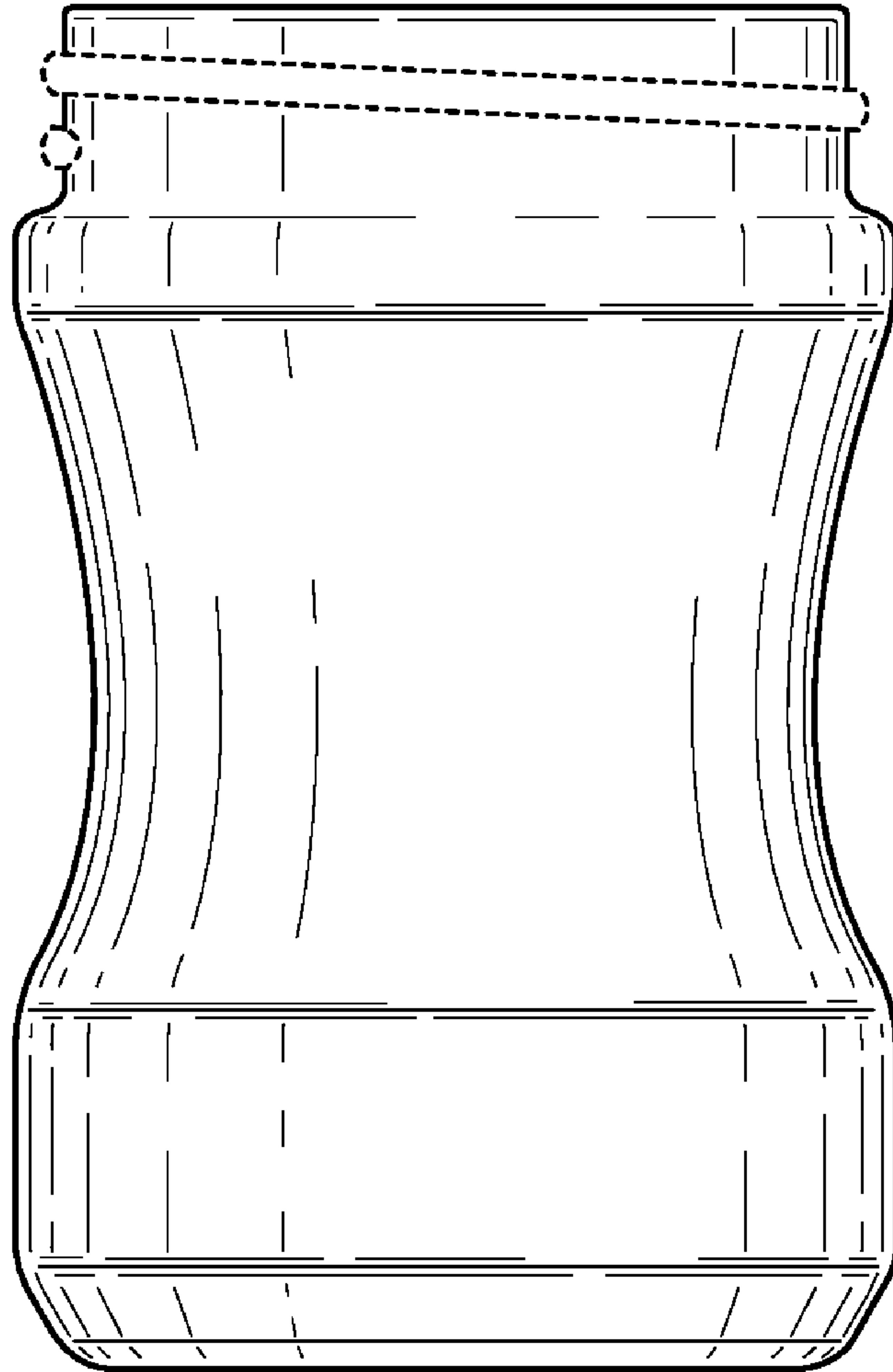

FIG. 11

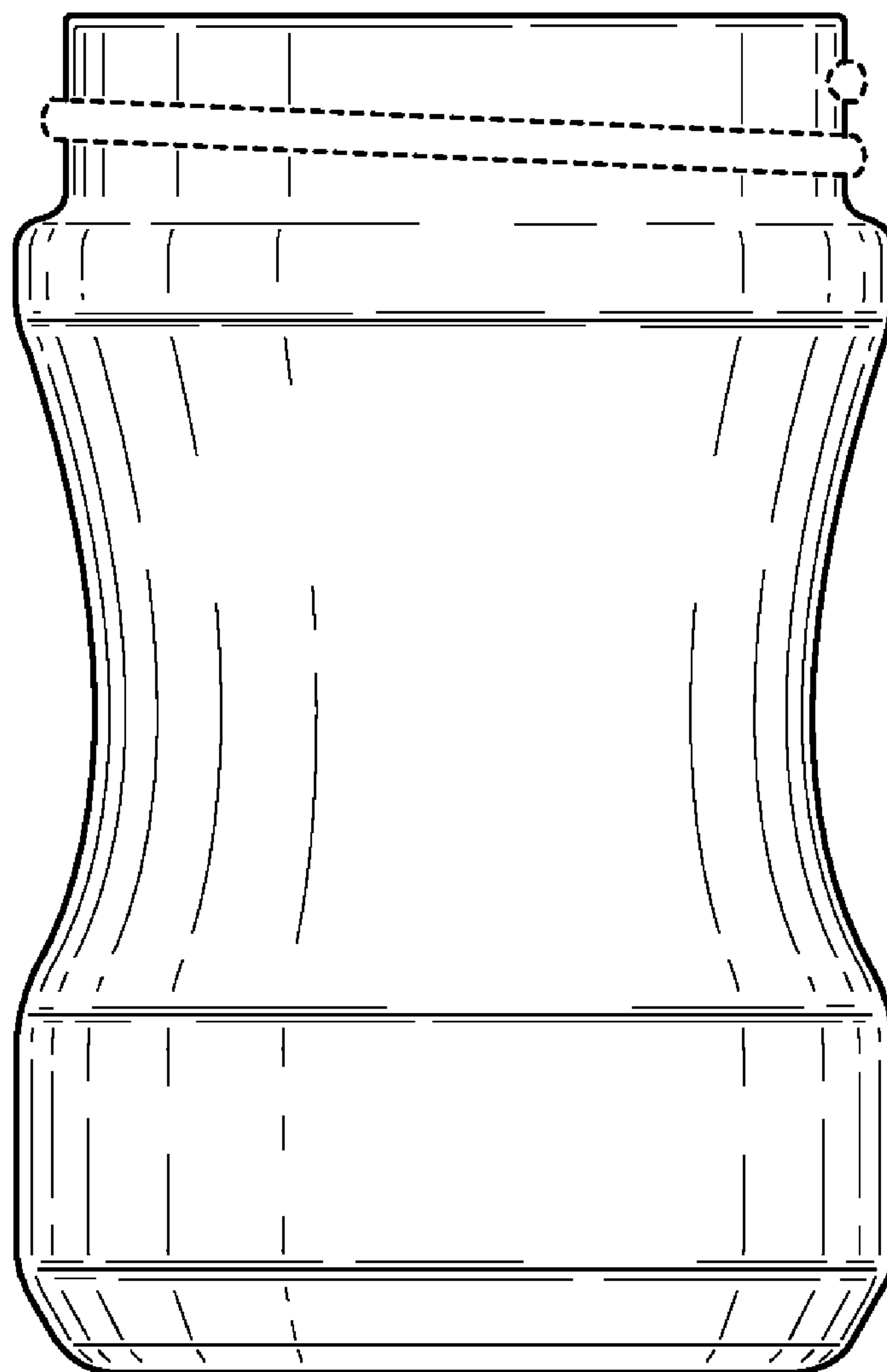

FIG. 12

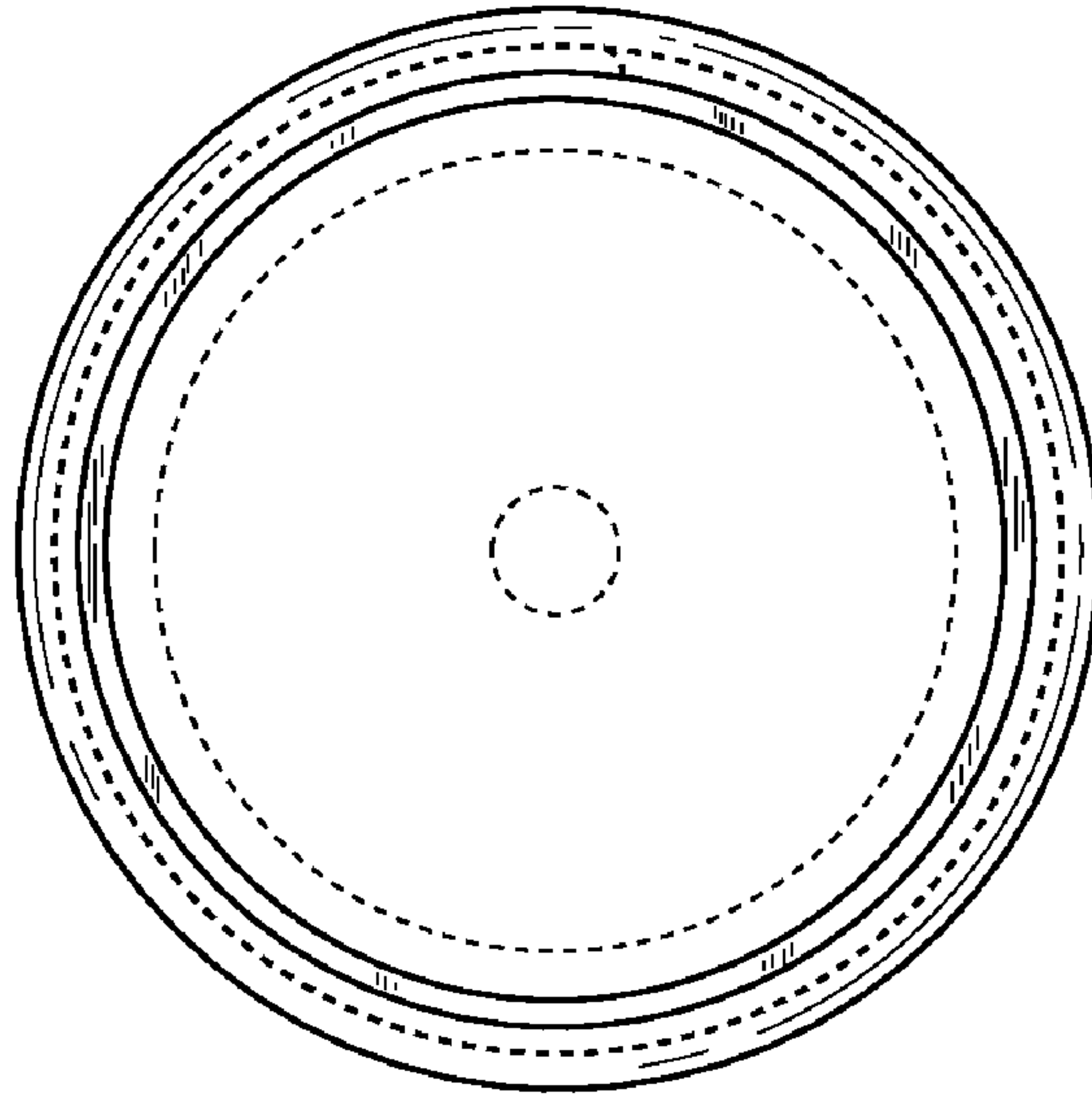

FIG. 13

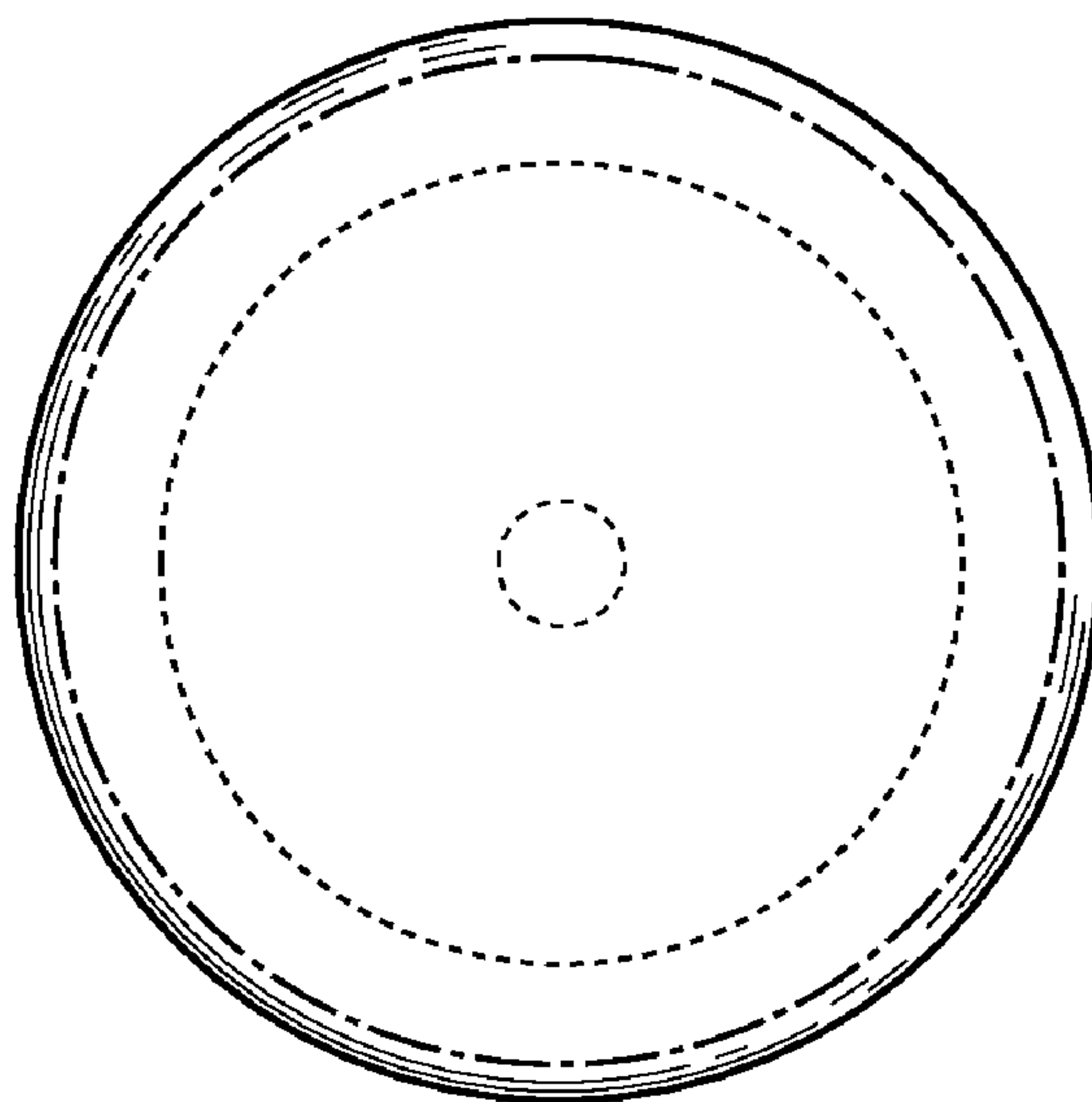

FIG. 14