



US00D609054S

(12) **United States Design Patent**
Gilbert

(10) **Patent No.:** **US D609,054 S**

(45) **Date of Patent:** **** Feb. 2, 2010**

(54) **BEVERAGE CONTAINER**

(75) Inventor: **Tyler Sean Gilbert**, Bellevue, WA (US)

(73) Assignee: **Pacific Market International, LLC**,
Seattle, WA (US)

(**) Term: **14 Years**

(21) Appl. No.: **29/306,460**

(22) Filed: **Apr. 9, 2008**

(51) **LOC (9) Cl.** **07-01**

(52) **U.S. Cl.** **D7/510; D7/511; D7/396.2**

(58) **Field of Classification Search** **D7/507-536,**
D7/396.2; 220/592.16, 703, 715, 737; 215/315;
206/520

See application file for complete search history.

(56) **References Cited**

U.S. PATENT DOCUMENTS

D263,916	S	*	4/1982	Reece	D7/510
5,249,703	A	*	10/1993	Karp	220/719
5,270,909	A		12/1993	Weiss et al.		
D417,365	S	*	12/1999	Huang	D7/511
D427,853	S	*	7/2000	Kohlhase	D7/510
D428,306	S	*	7/2000	Lee	D7/510
D428,769	S	*	8/2000	Mensch et al.	D7/533
D433,877	S	*	11/2000	Bickert et al.	D7/536
D465,132	S	*	11/2002	Janky et al.	D7/510
D486,997	S	*	2/2004	Janky	D7/531
D533,403	S	*	12/2006	Bhavnani	D7/510
D547,121	S	*	7/2007	Friedman	D7/511
D548,522	S	*	8/2007	Greenspon	D7/507

D562,072	S	*	2/2008	Wahl	D7/510
D571,613	S	*	6/2008	Gilbert et al.	D7/533
D572,531	S	*	7/2008	Romandy et al.	D7/510
D587,967	S	*	3/2009	Wahl	D7/510
D595,089	S	*	6/2009	Wahl	D7/510

OTHER PUBLICATIONS

U.S. Appl. No. 29/306,458, filed Apr. 9, 2008, Gilbert.

* cited by examiner

Primary Examiner—Marianne Pandozzi

(74) *Attorney, Agent, or Firm*—Davis Wright Tremaine LLP;
George C. Rondeau, Jr.

(57) **CLAIM**

The ornamental design for a beverage container, as shown and described.

DESCRIPTION

FIG. 1 is a top right side perspective view of a third embodiment thereof.

FIG. 2 a front elevational view thereof.

FIG. 3 is a rear elevational view thereof.

FIG. 4 is a right side elevational view thereof.

FIG. 5 is a left side elevational view thereof.

FIG. 6 is a top plan view thereof; and,

FIG. 7 is a bottom plan view thereof.

The broken lines are for illustrative purposes only and form no part of the claimed design.

1 Claim, 6 Drawing Sheets

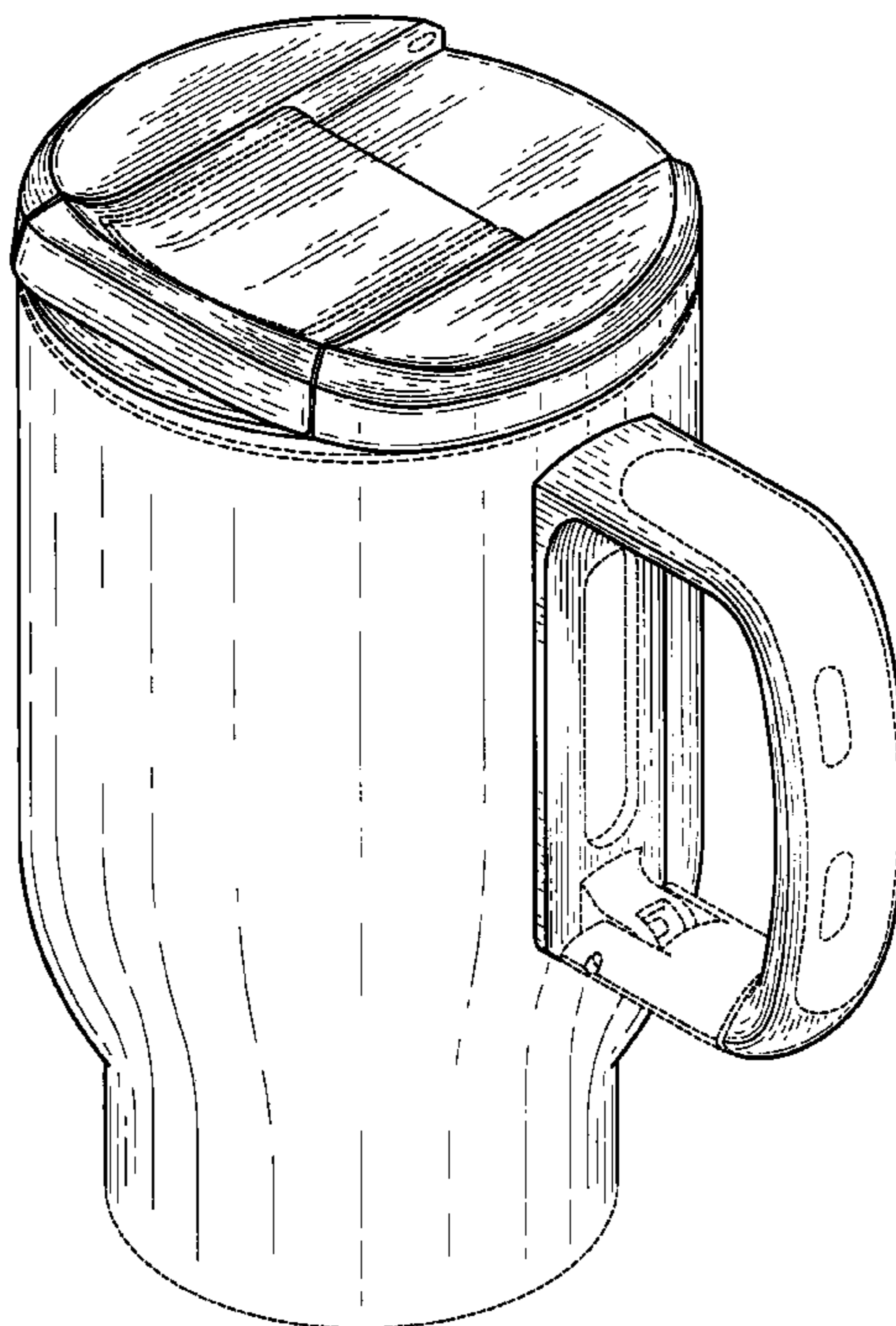

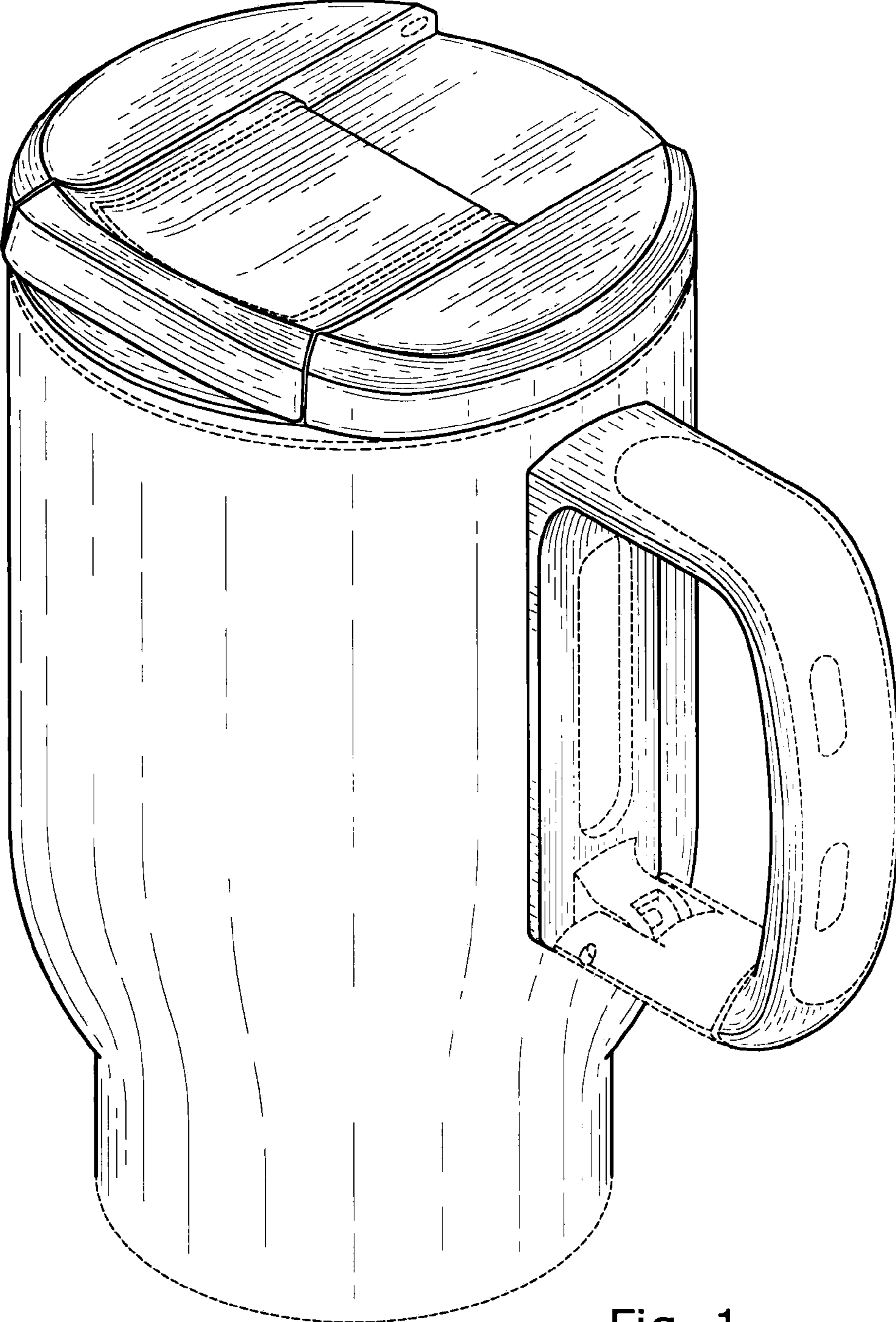

Fig. 1

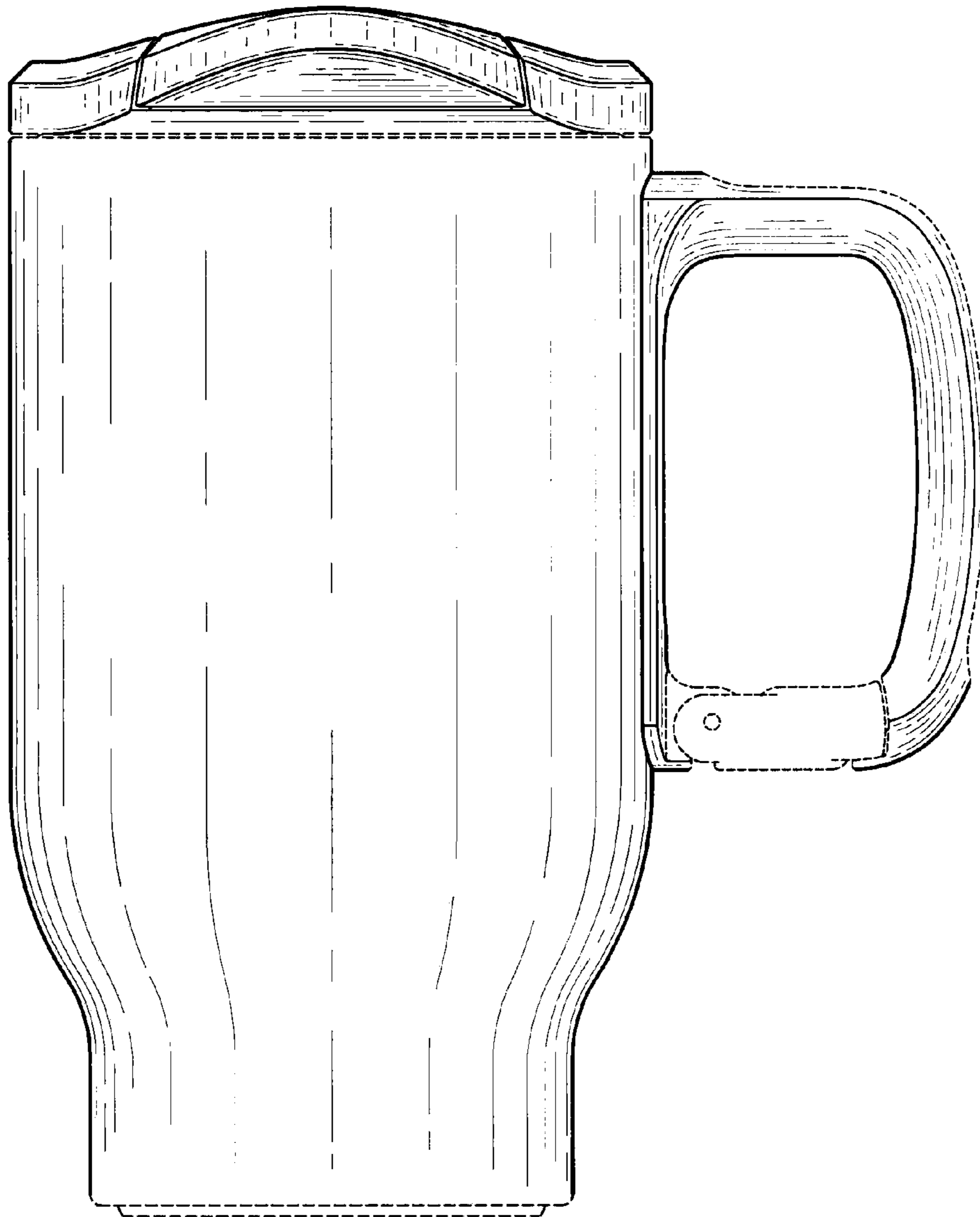

Fig. 2

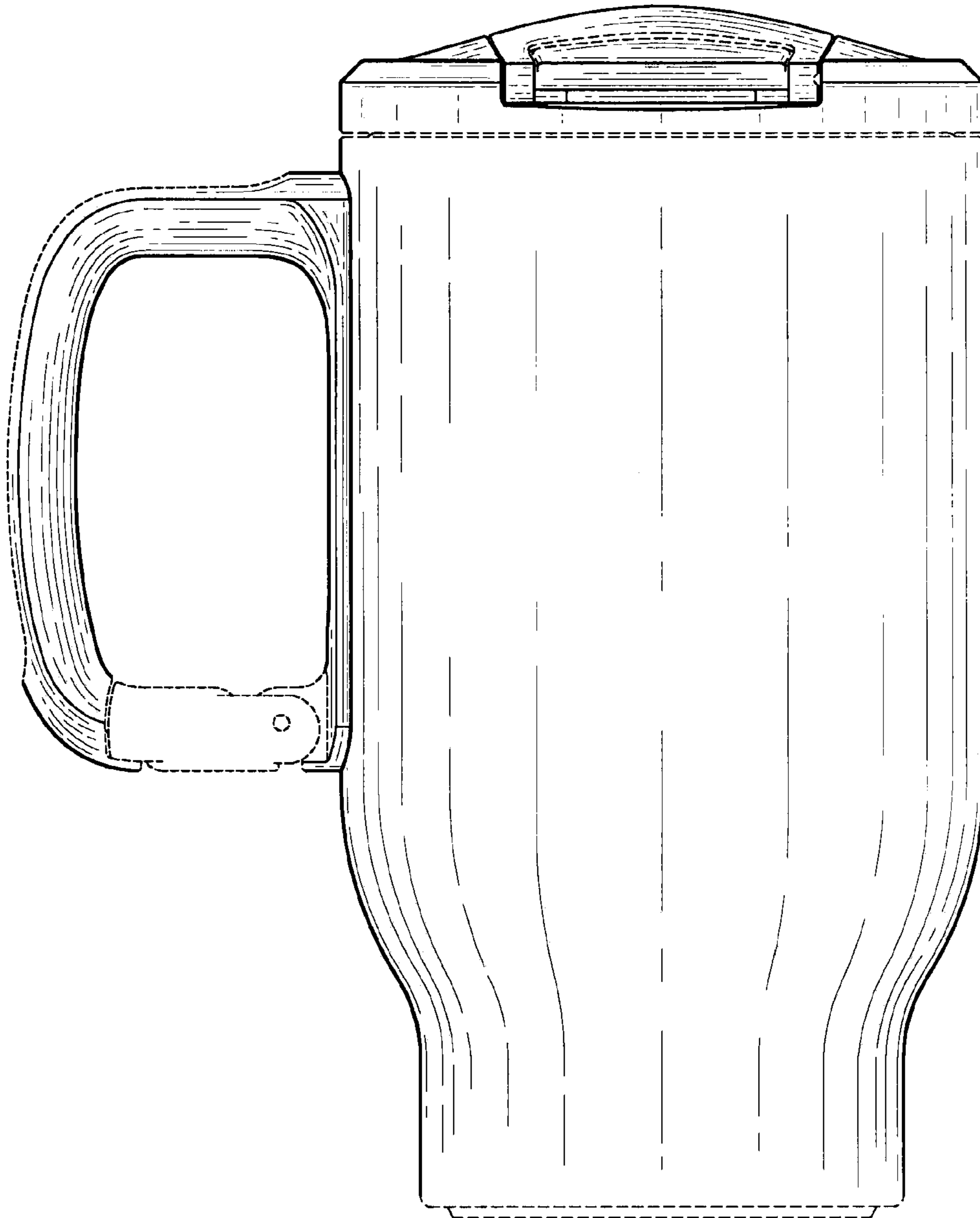

Fig. 3

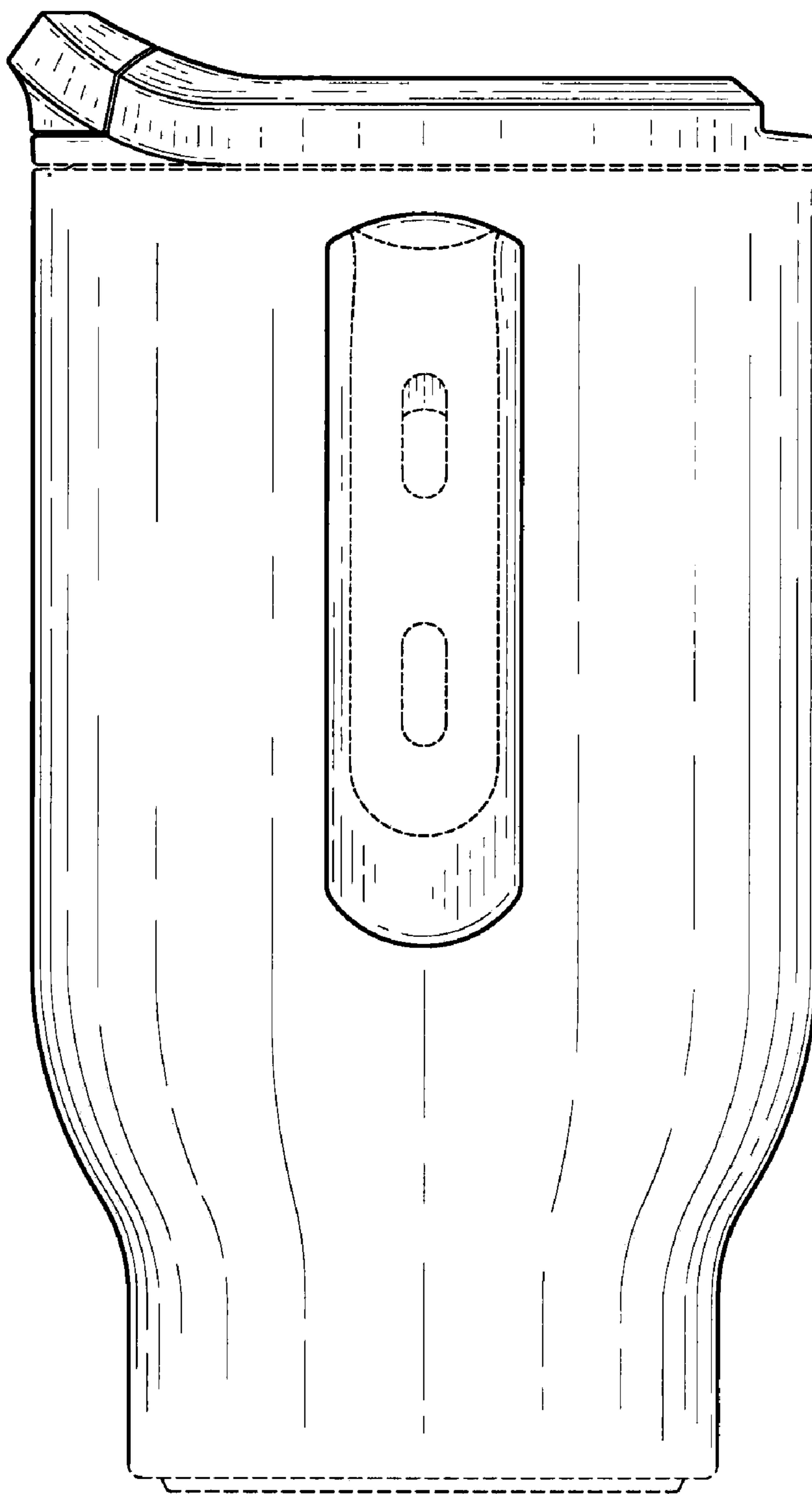

Fig. 4

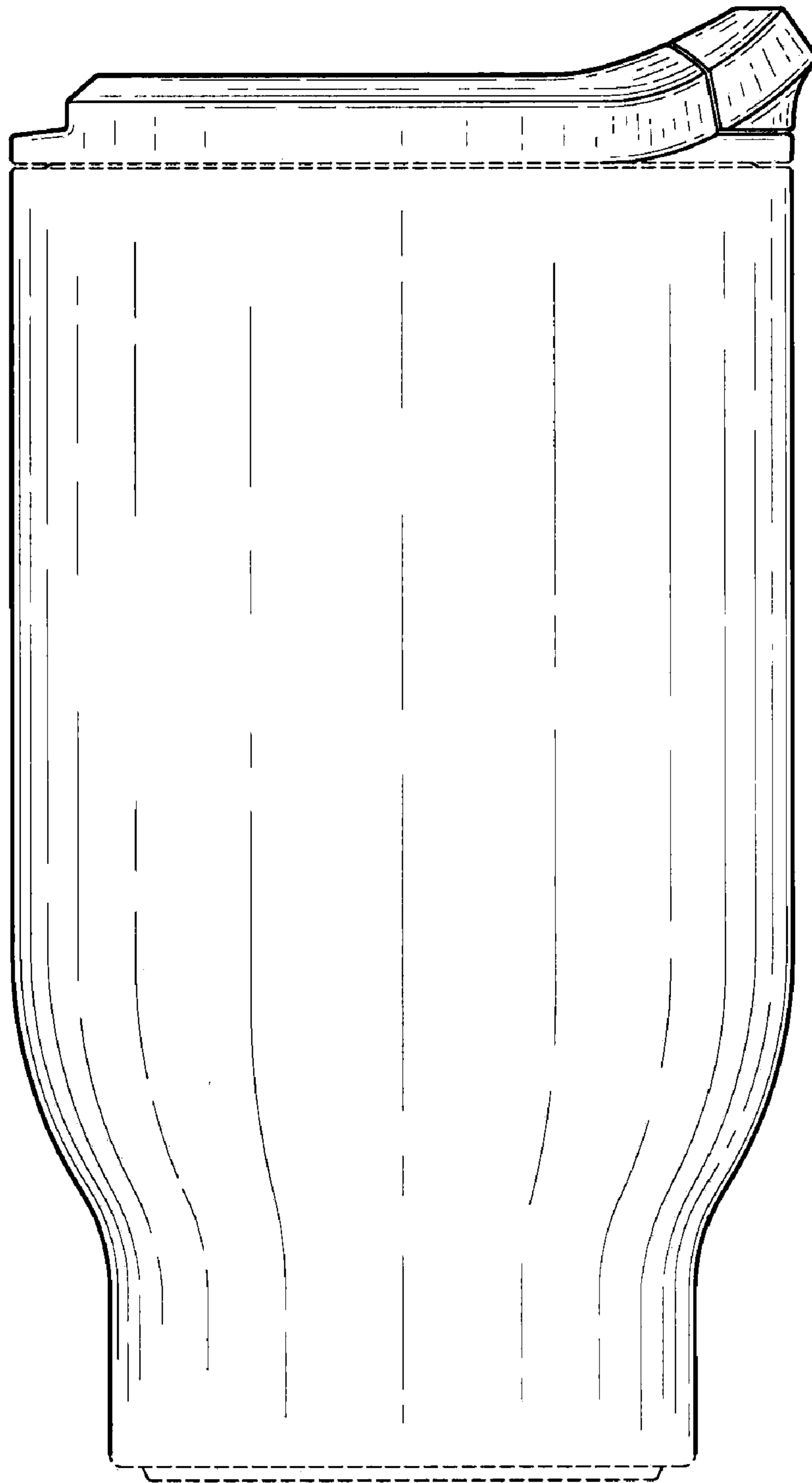

Fig. 5

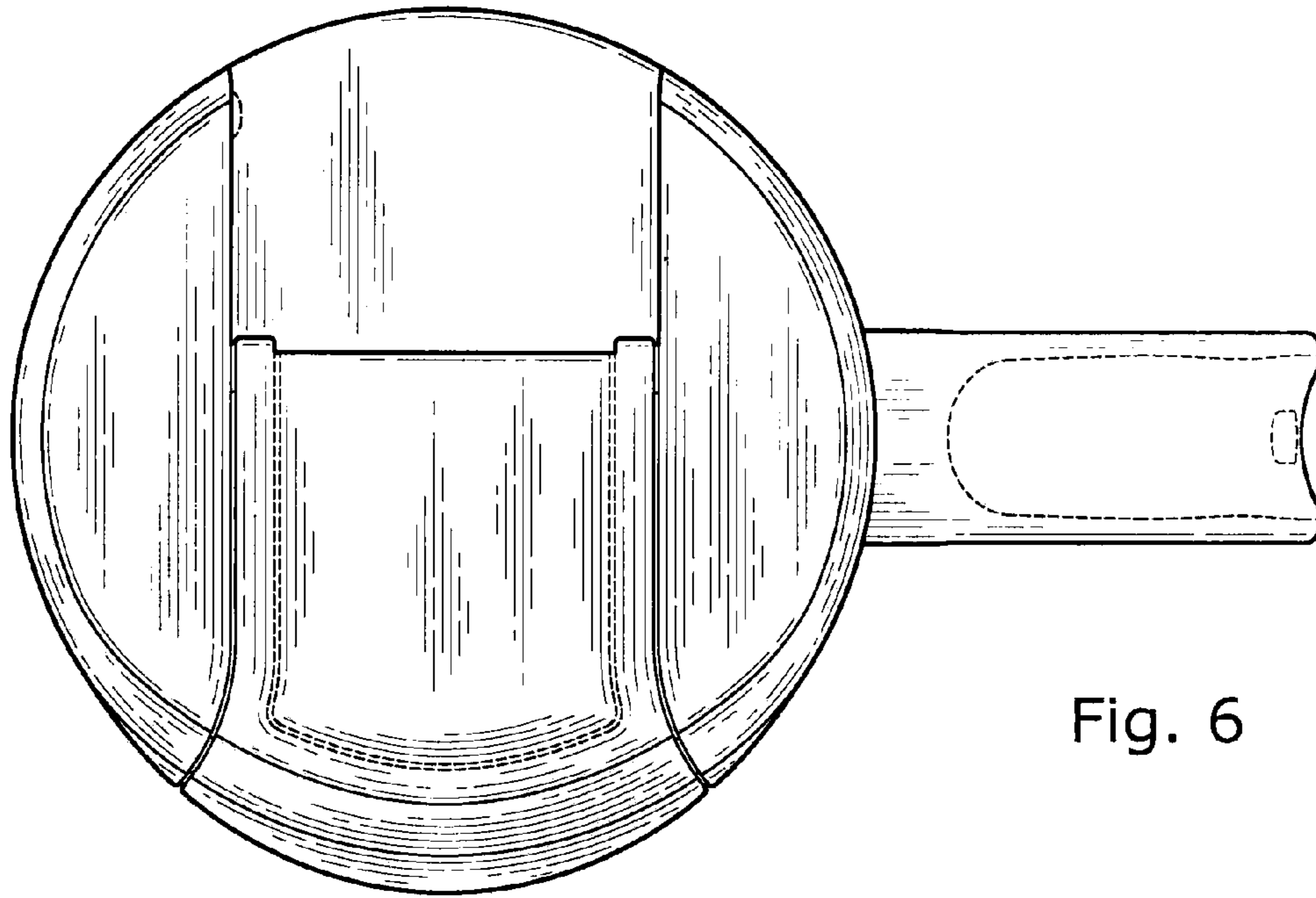

Fig. 6

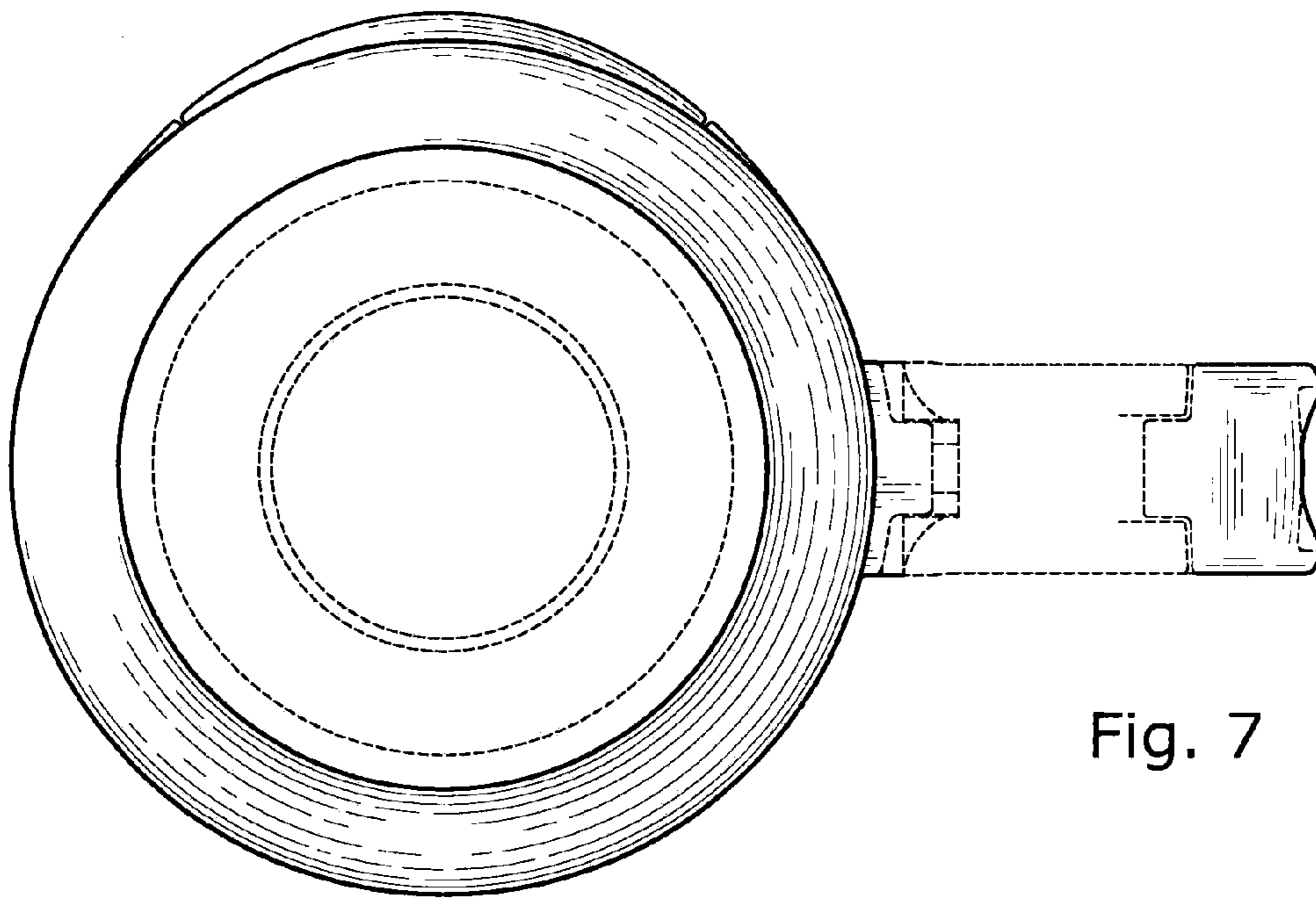

Fig. 7