



US00D608951S

(12) **United States Design Patent**  
**Wiens**

(10) **Patent No.:** **US D608,951 S**

(45) **Date of Patent:** **\*\* Jan. 26, 2010**

(54) **COMBINED JOCK CUP AND AIR BLADDER**

(74) *Attorney, Agent, or Firm*—Richard John Bartz

(76) **Inventor:** **Joel J. Wiens**, 10570 202nd St. West,  
Lakeville, MN (US) 55044

(57) **CLAIM**

The ornamental design of the combined jock cup and air bladder, as shown and described.

(\*\*) **Term:** **14 Years**

(21) **Appl. No.:** **29/313,198**

**DESCRIPTION**

(22) **Filed:** **Dec. 15, 2008**

(51) **LOC (9) Cl.** ..... **09-03**

FIG. 1 is a front elevational view of a combined jock cup and air bladder, showing my new design, shown in the closed condition;

(52) **U.S. Cl.** ..... **D29/101.5; D2/711**

FIG. 2 is a rear elevational view thereof;

(58) **Field of Classification Search** ..... D2/711,  
D2/713; 2/466, 405; D29/101.5; D24/124–125;  
128/846; 604/352–353

FIG. 3 is a right side elevational view thereof, whereas the left side is a mirror image;

See application file for complete search history.

FIG. 4 is a top plan view thereof;

(56) **References Cited**

FIG. 5 is a bottom plan view thereof;

**U.S. PATENT DOCUMENTS**

FIG. 6 is a front elevational view thereof, shown in the opened condition;

3,176,686 A \* 4/1965 Barnes ..... 128/846

FIG. 7 is a rear elevational view thereof;

D252,116 S \* 6/1979 DiMatteo ..... D2/711

FIG. 8 is a right side elevational view thereof, whereas the left side elevational view is a mirror image;

5,984,910 A \* 11/1999 Berke ..... 604/352

FIG. 9 is a top plan view thereof; and,

6,635,038 B2 \* 10/2003 Scovel ..... 604/353

FIG. 10 is a bottom plan view thereof.

7,141,043 B2 \* 11/2006 Harvie ..... 604/347

The broken lines shown in FIGS. 6 and 7 of the drawing views are for environmental structure only and form no part of the claimed design.

D571,532 S \* 6/2008 Gutierrez ..... D2/713

D579,628 S \* 11/2008 Wiens ..... D2/711

D595,902 S \* 7/2009 Wiens ..... D29/101.5

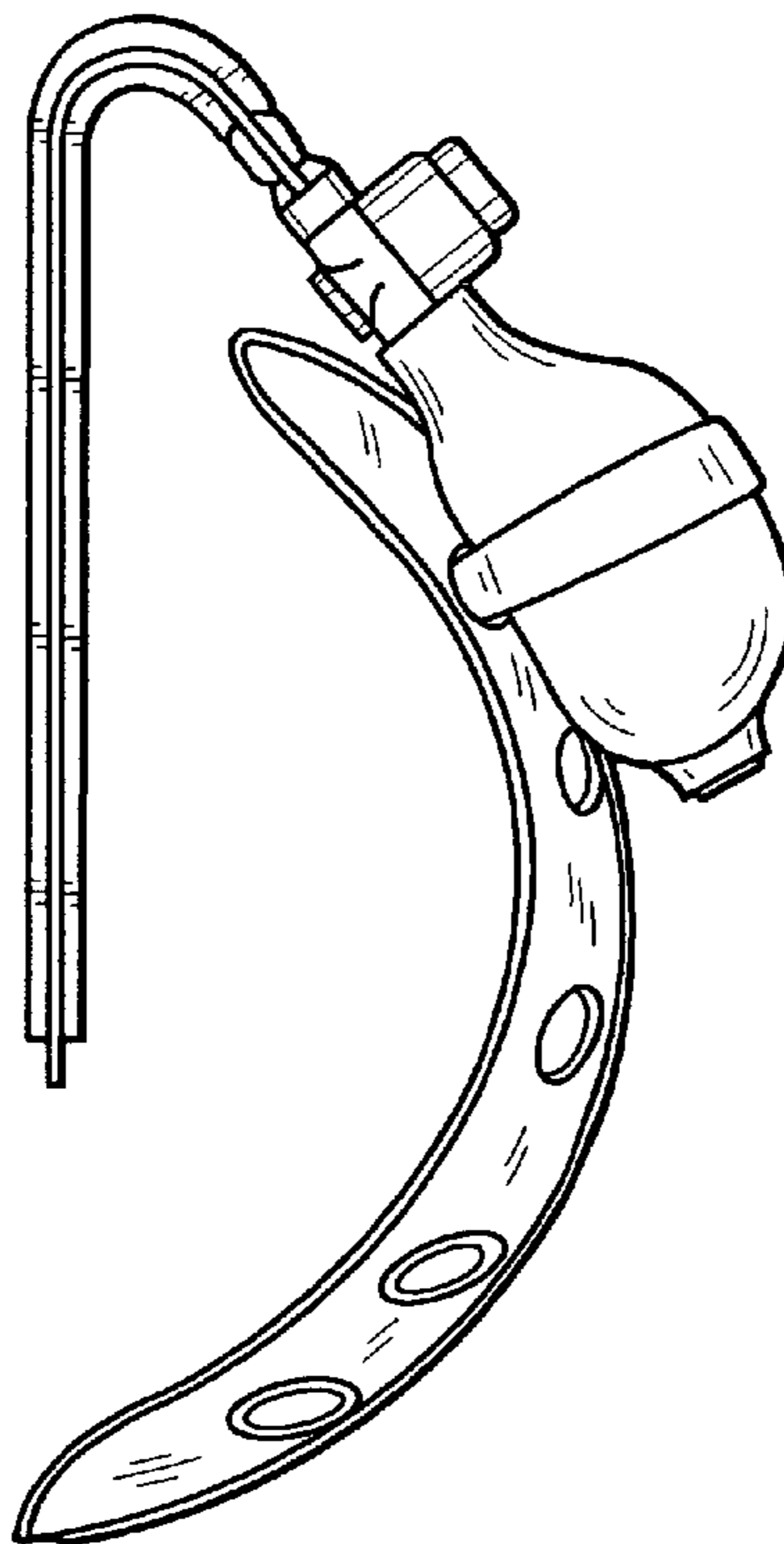
7,578,009 B1 \* 8/2009 Boston ..... 2/405

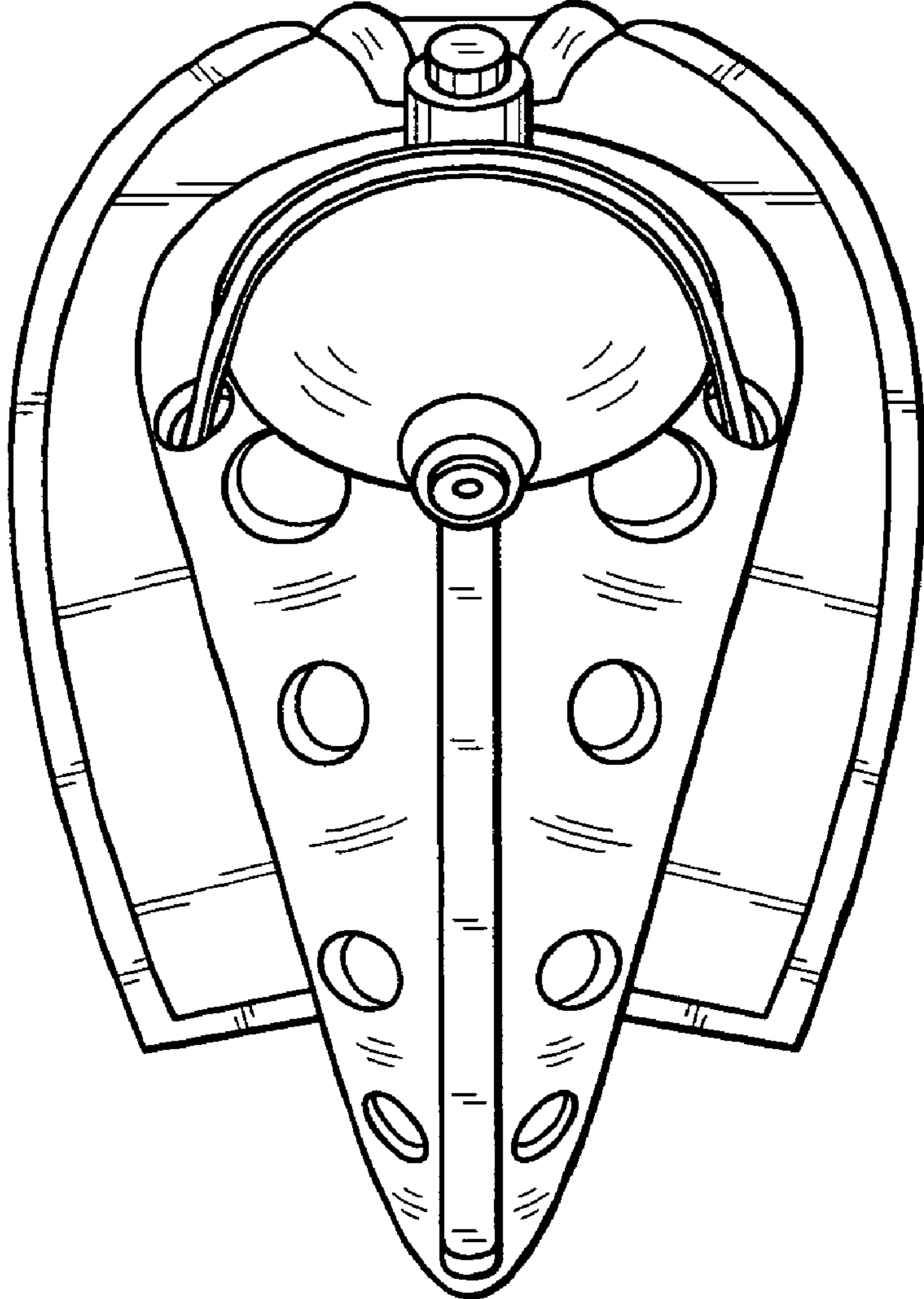
\* cited by examiner

*Primary Examiner*—Ian Simmons

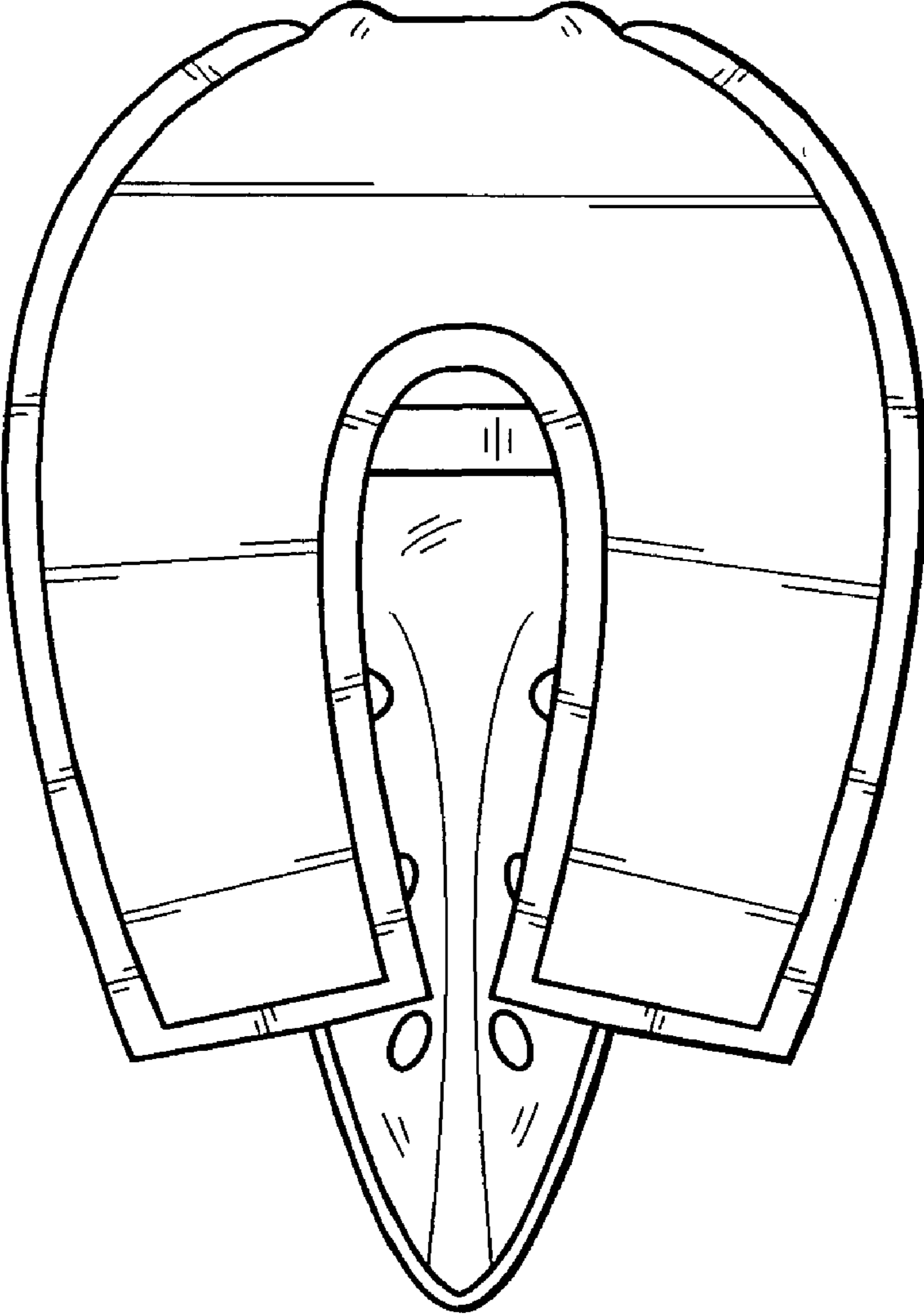
**1 Claim, 10 Drawing Sheets**

*Assistant Examiner*—Anna J Burmeister

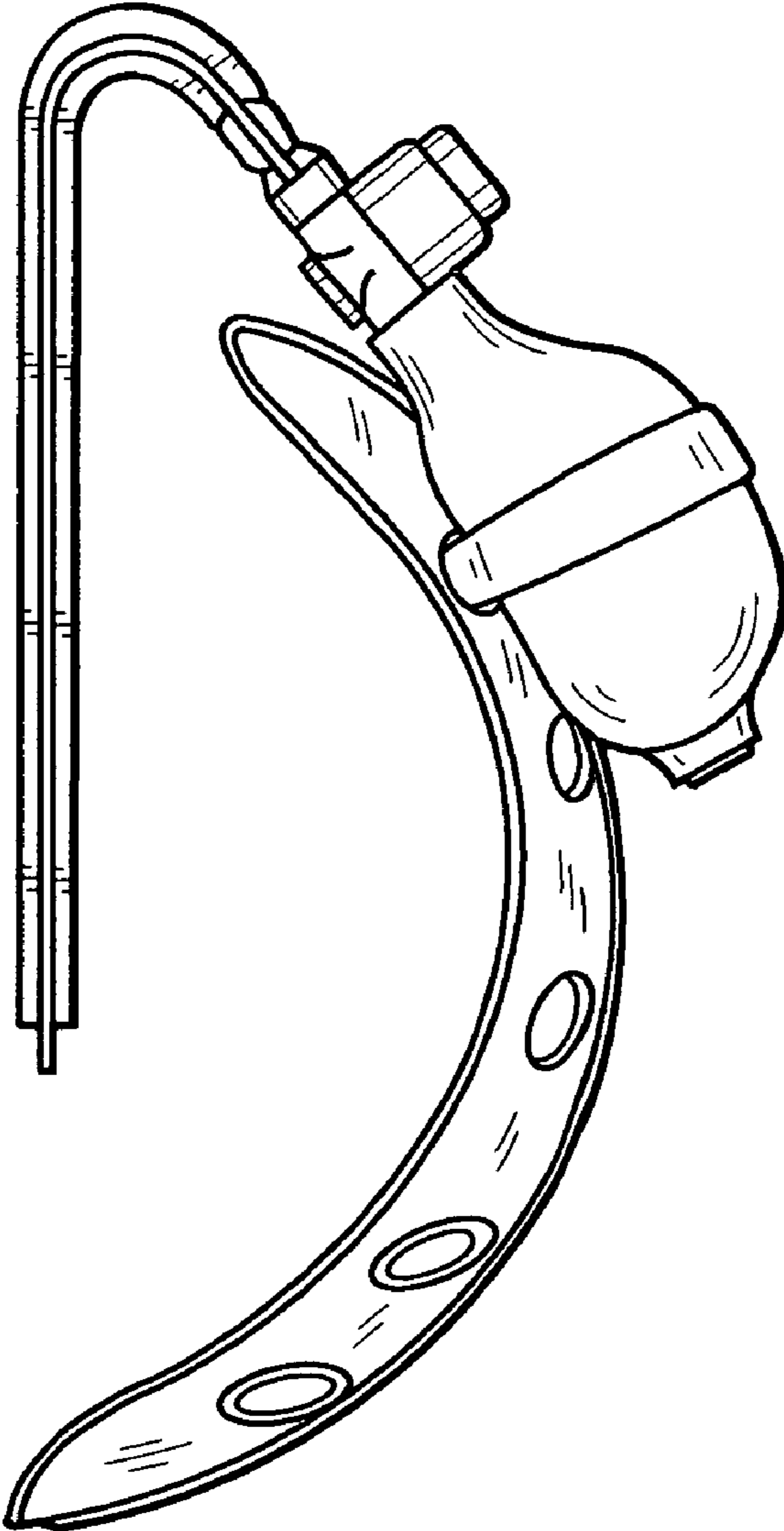




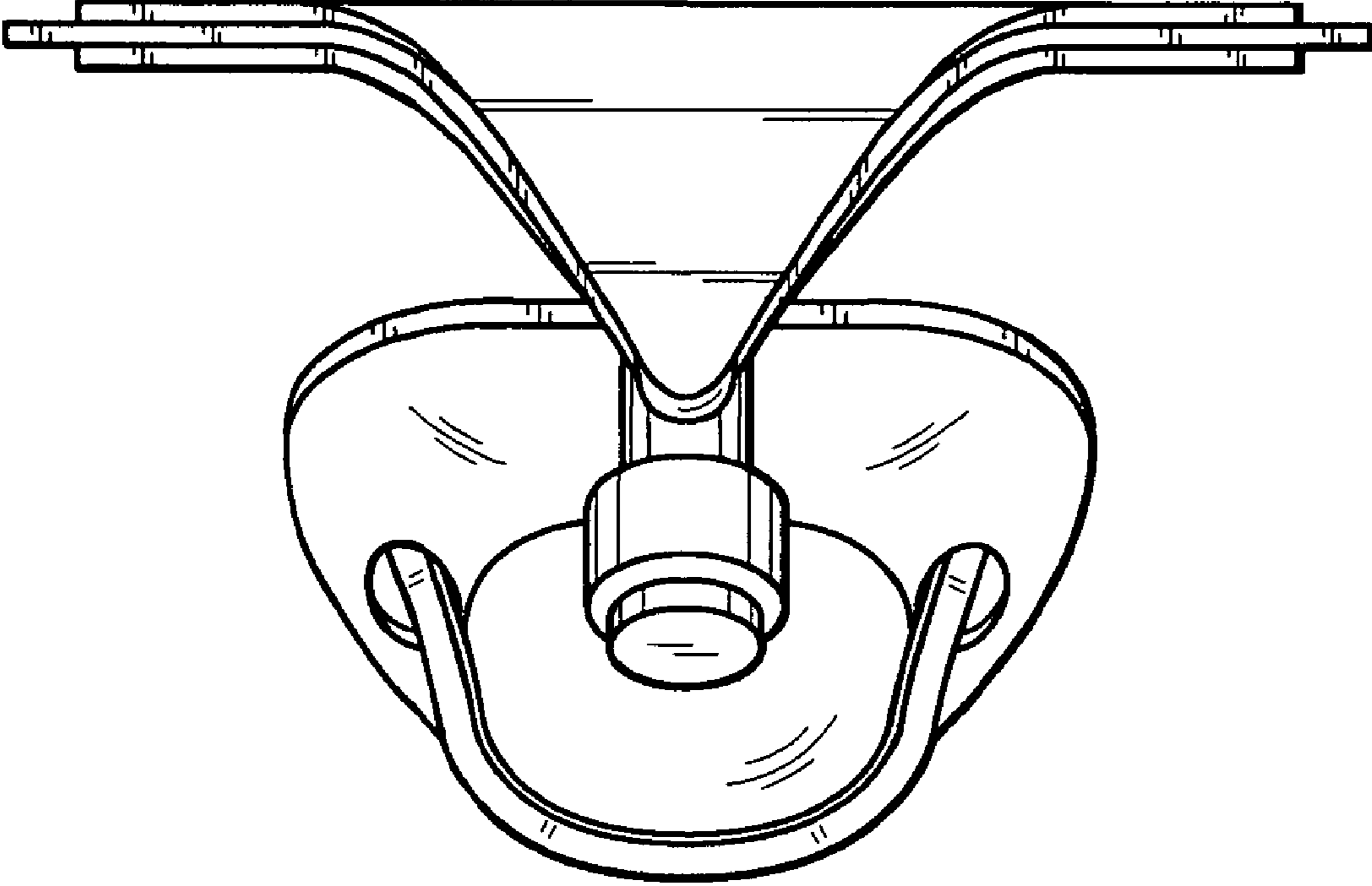
**FIG. 1**



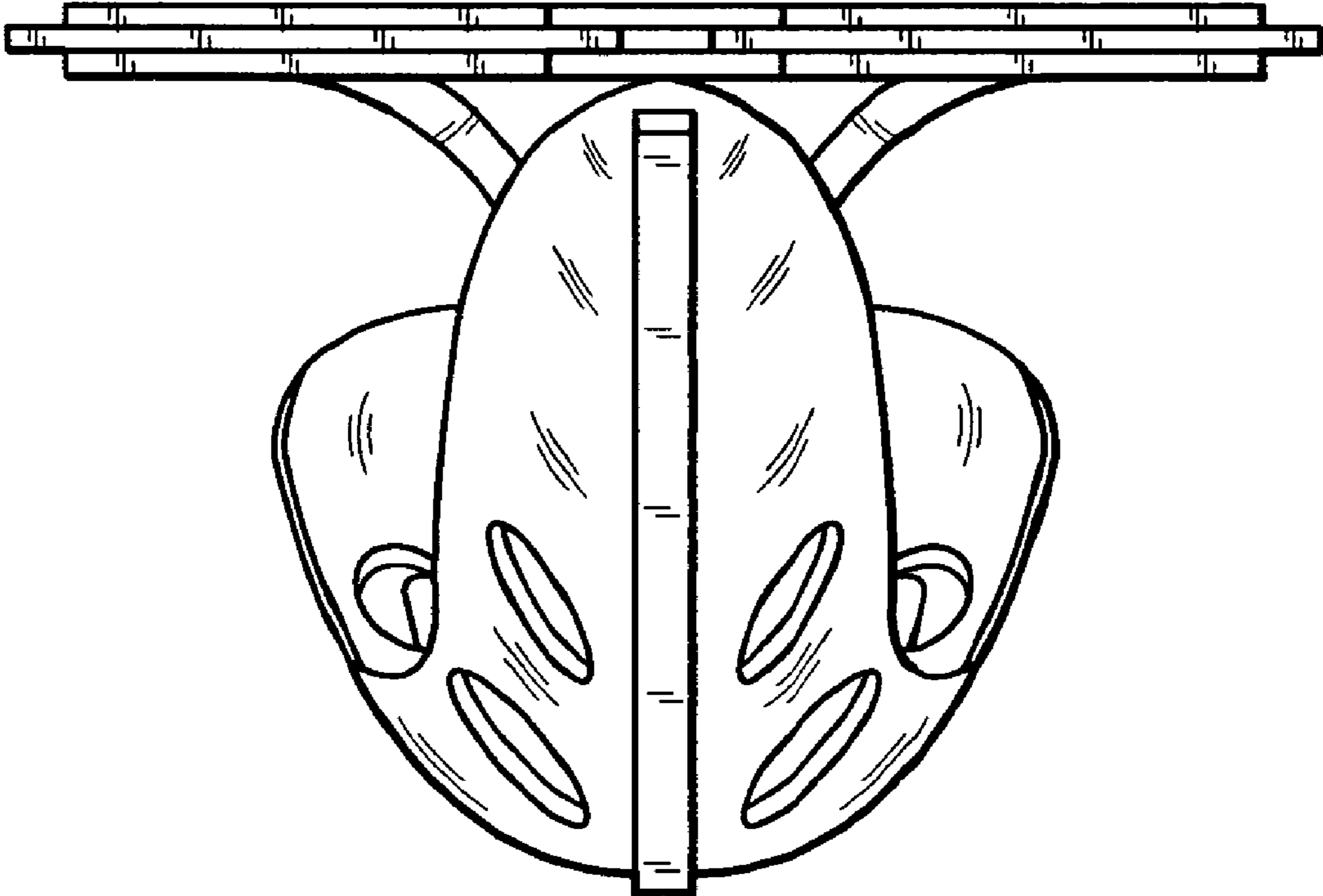
**FIG. 2**



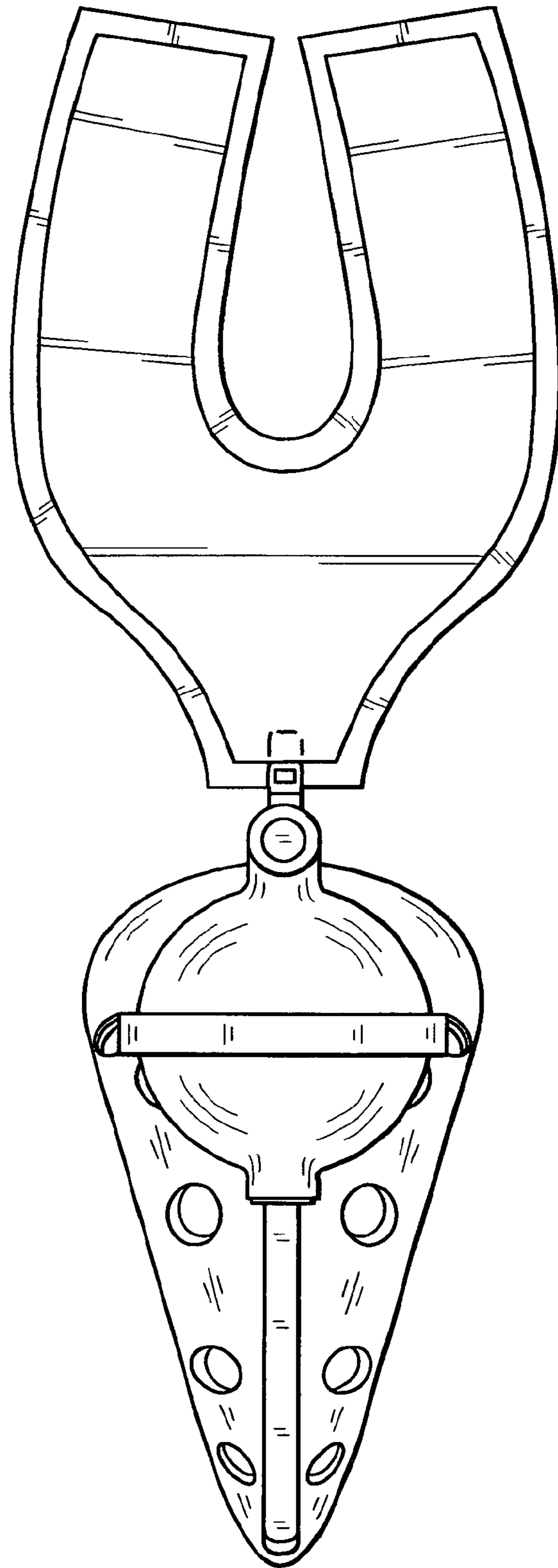
**FIG. 3**



**FIG. 4**

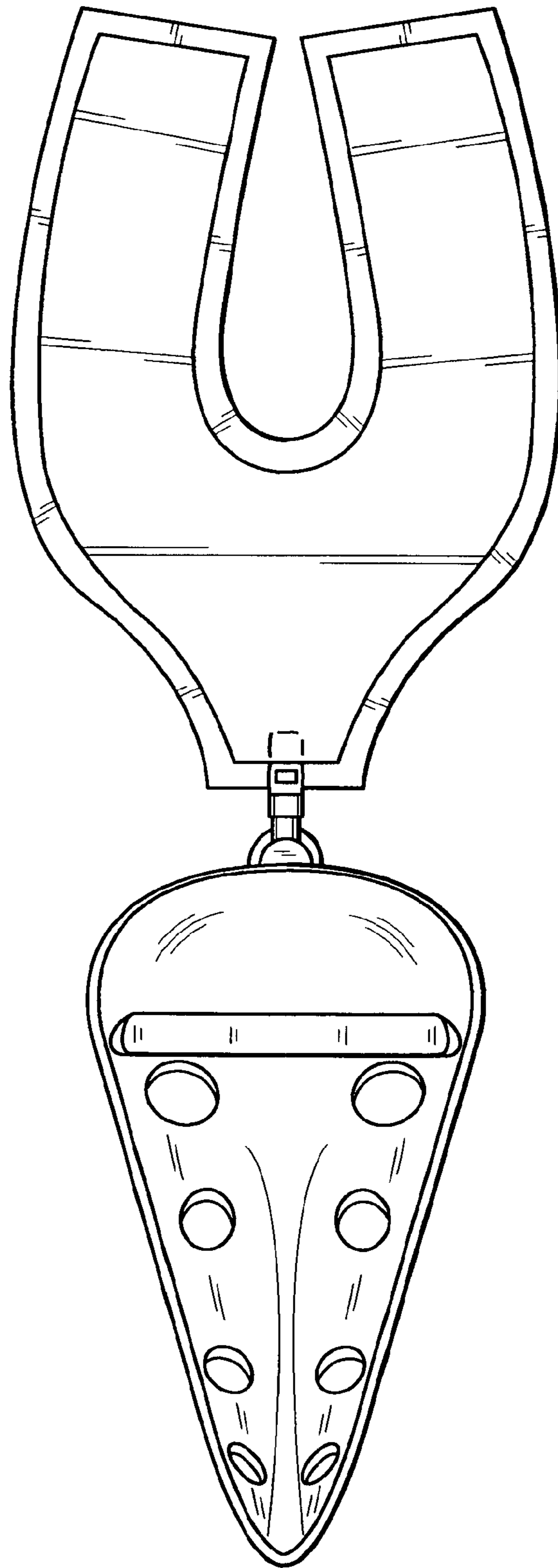


**FIG. 5**



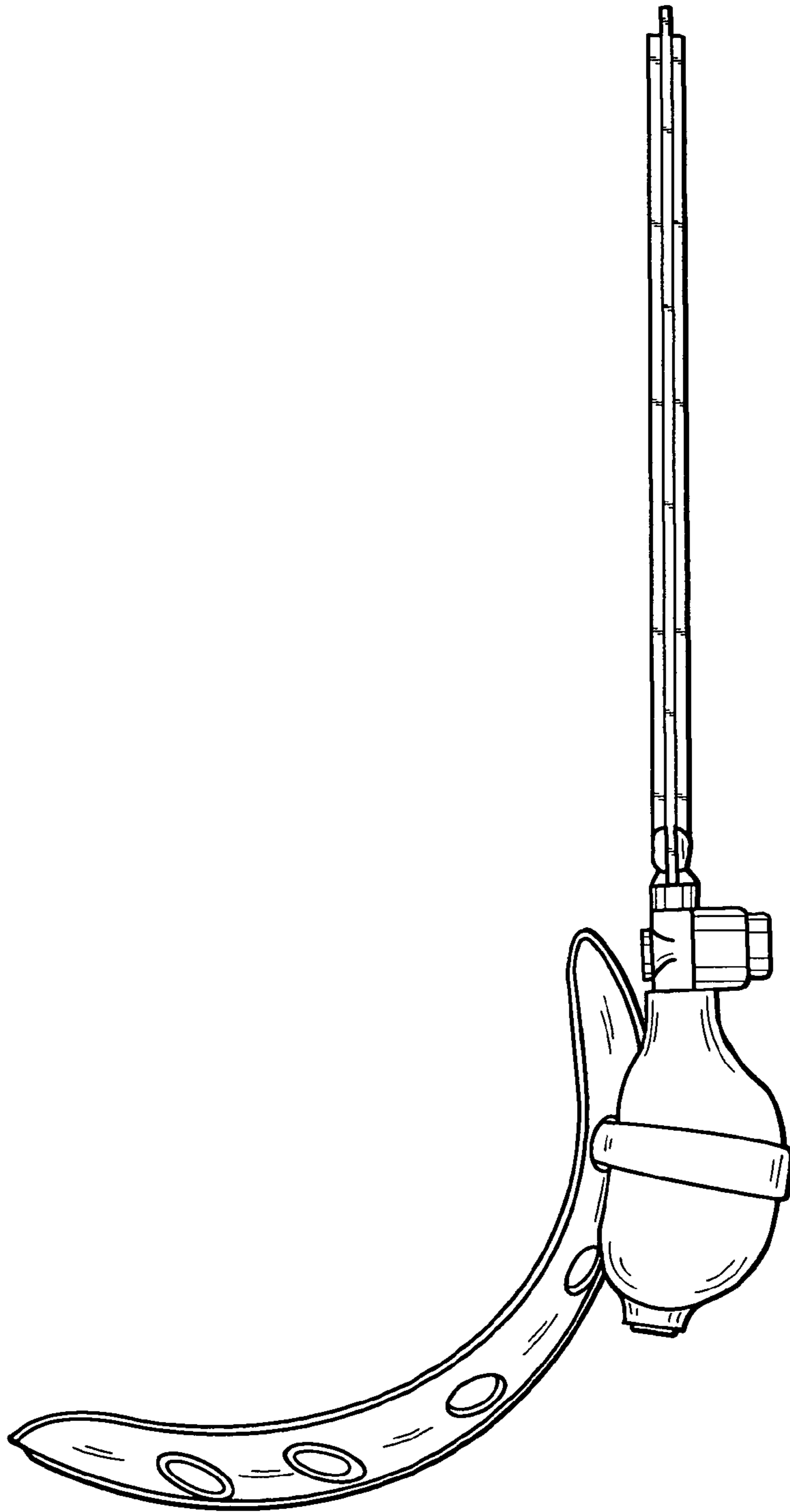
**FIG. 6**



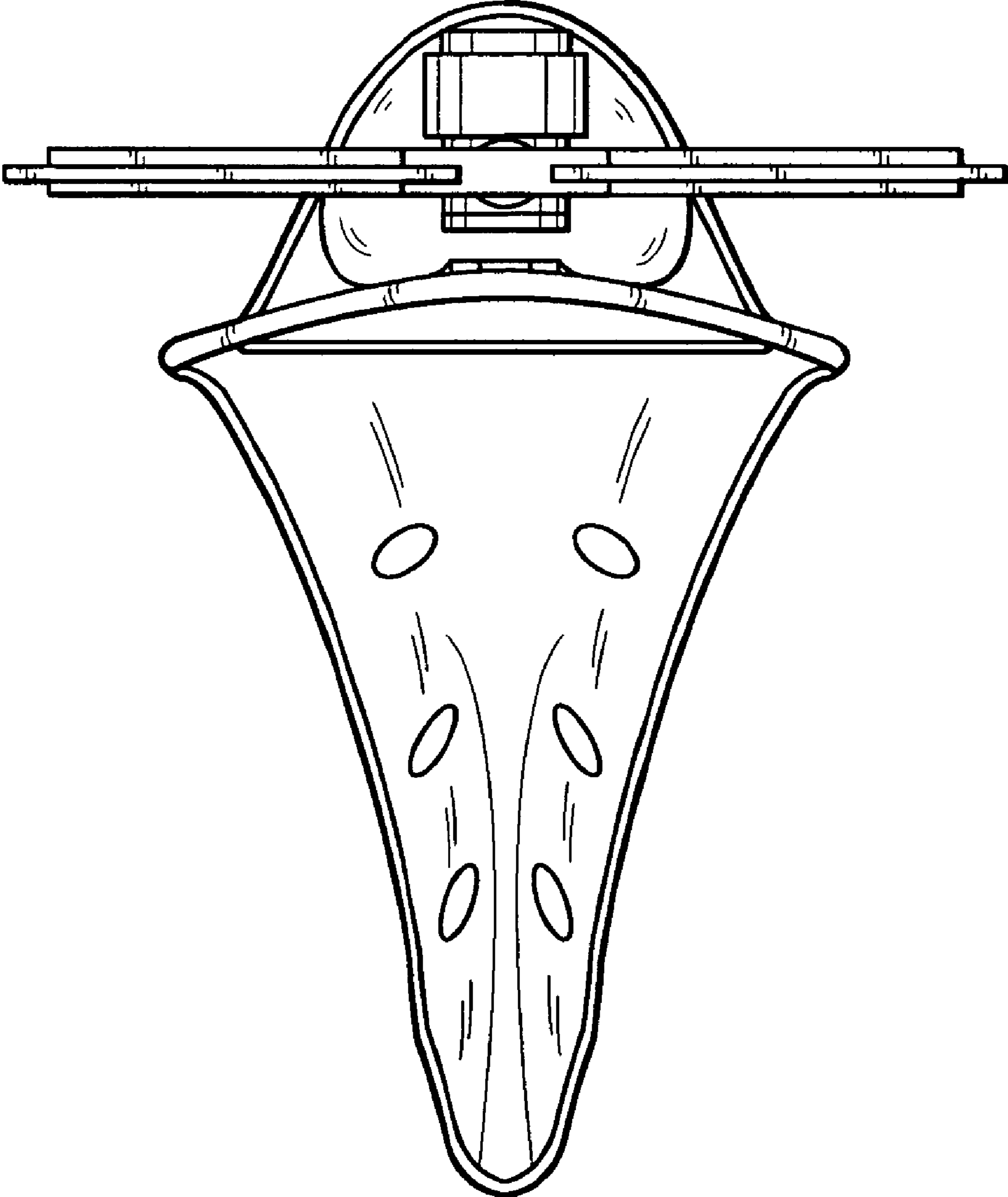


**FIG. 7**

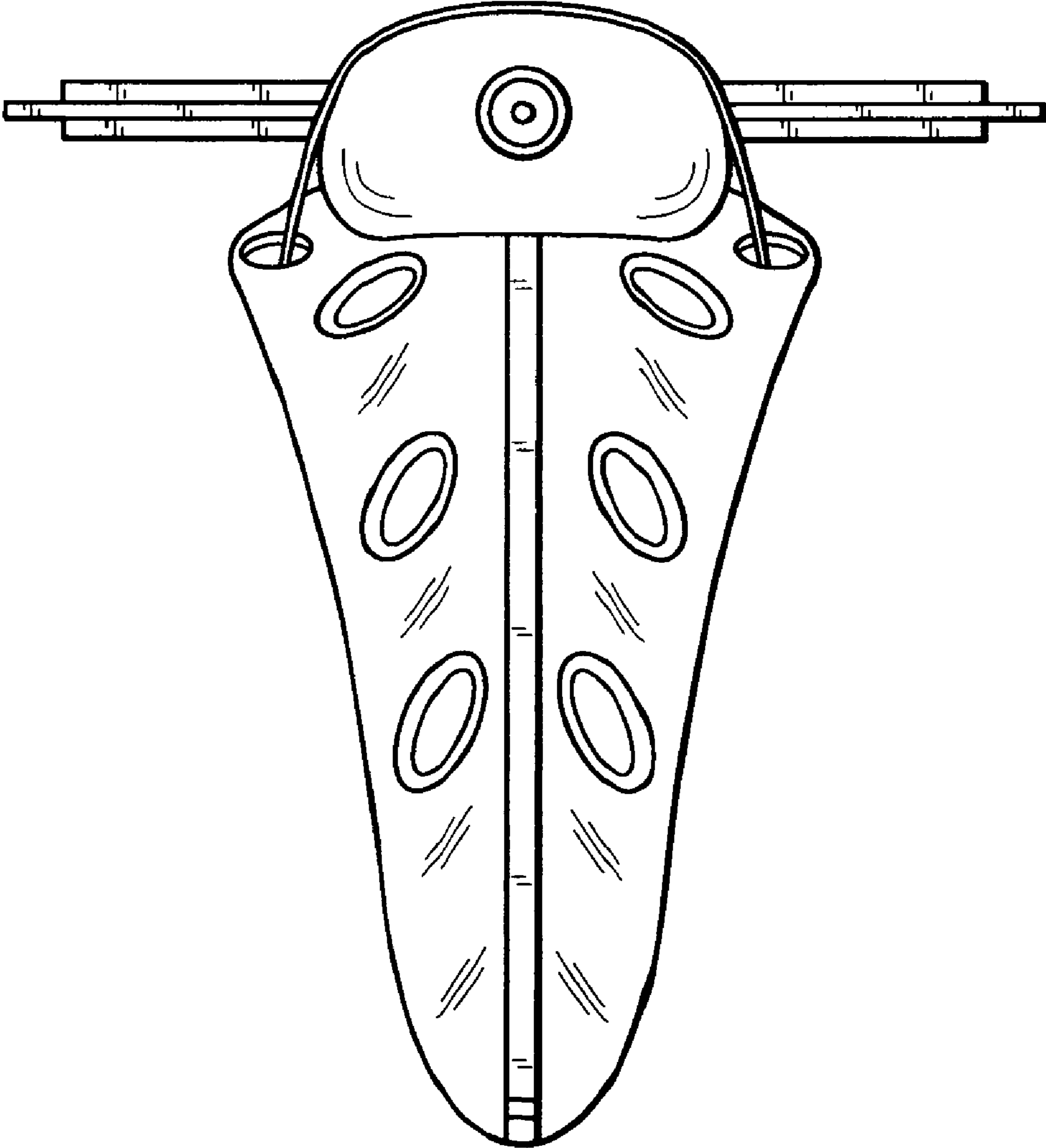




**FIG. 8**



**FIG. 9**



**FIG. 10**