



US00D608637S

(12) **United States Design Patent**
Getsy

(10) **Patent No.:** **US D608,637 S**

(45) **Date of Patent:** **** Jan. 26, 2010**

(54) **BAG HANDLE**

(75) Inventor: **Stephen Getsy**, Bridgeville, PA (US)

(73) Assignee: **Silgan Plastics Corporation**, Norcross, GA (US)

(**) Term: **14 Years**

(21) Appl. No.: **29/340,079**

(22) Filed: **Jul. 13, 2009**

(51) **LOC (9) Cl.** **09-07**

(52) **U.S. Cl.** **D9/434**

(58) **Field of Classification Search** D9/705,
D9/635, 520, 517, 516, 456, 455, 454, 452,
D9/444, 445, 438, 436, 435, 434, 433, 432,
D9/416.499; D26/51; 428/138; 362/101;
229/404, 128, 110, 103.3; 220/630; 206/776,
206/755, 754, 583, 522, 453, 390, 232; D7/509,
D7/511, 396.2, 624.2, 602

See application file for complete search history.

(56) **References Cited**

U.S. PATENT DOCUMENTS

D222,239 S * 10/1971 Chan D9/434
D242,764 S * 12/1976 Kamins D9/434
D290,935 S * 7/1987 Williams D9/434

D409,913 S * 5/1999 Le Roux D9/434
D412,116 S * 7/1999 DuCorday D9/443
D430,030 S * 8/2000 DuCorday D9/443
D430,490 S * 9/2000 DuCorday D9/443
D447,413 S * 9/2001 DuCorday D9/443

OTHER PUBLICATIONS

Pictures of Bag Handles and Bags believed to be sold by at least 2004, 7 pages.

* cited by examiner

Primary Examiner—Susan Bennett Hattan

(74) *Attorney, Agent, or Firm*—Foley & Lardner LLP

(57) **CLAIM**

We claim the ornamental design for a bag handle, as shown and described.

DESCRIPTION

FIG. 1 is a top perspective view of the claimed design;
FIG. 2 is a bottom perspective view of the claimed design;
FIG. 3 is a front view of the claimed design;
FIG. 4 is a side view of the claimed design;
FIG. 5 is a top view of the claimed design; and,
FIG. 6 is a bottom view of the claimed design.

1 Claim, 5 Drawing Sheets

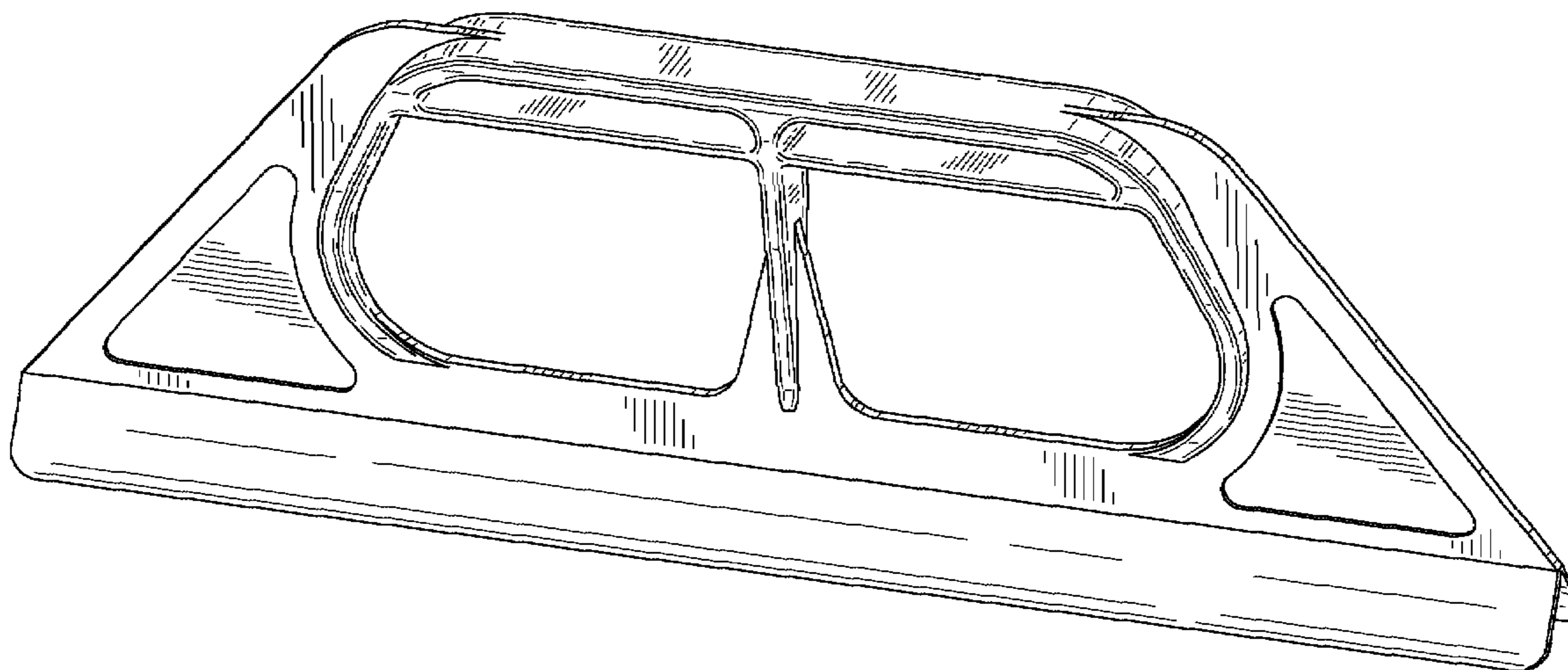

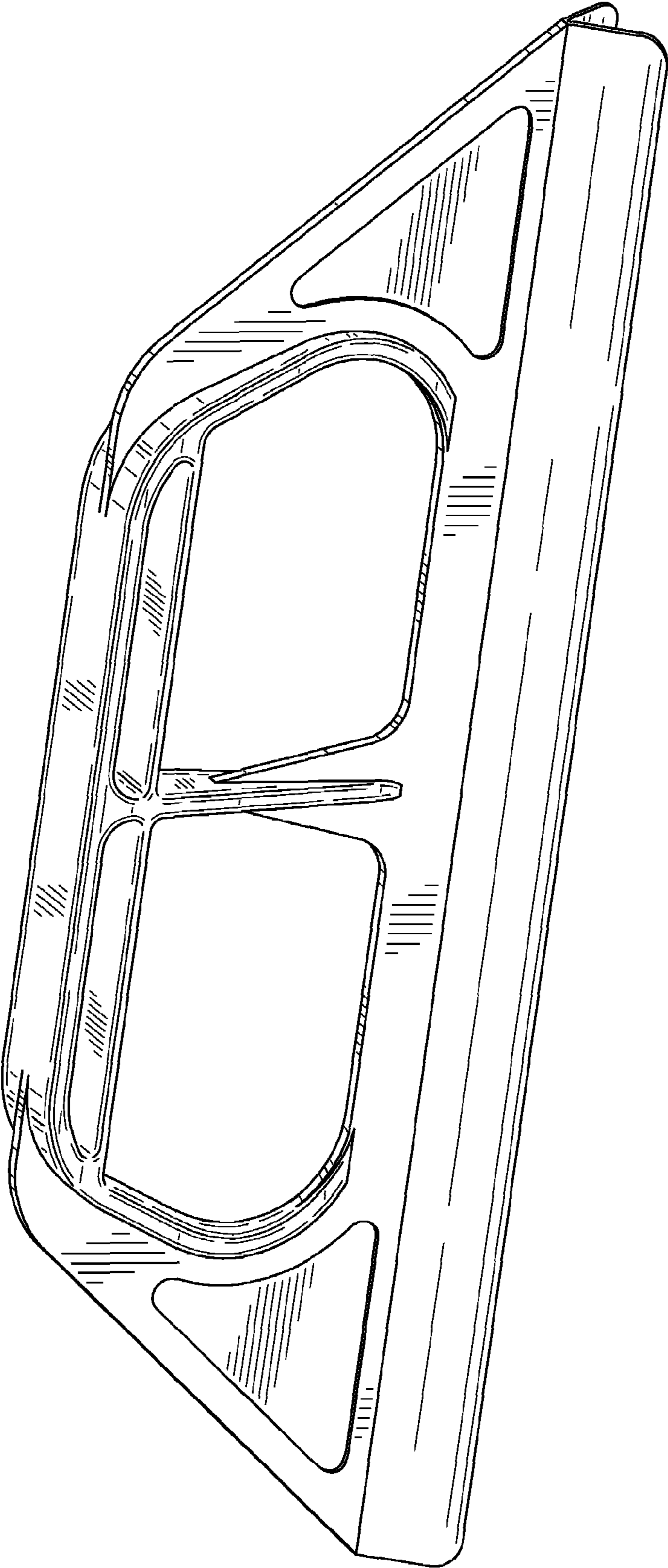

FIG. 1

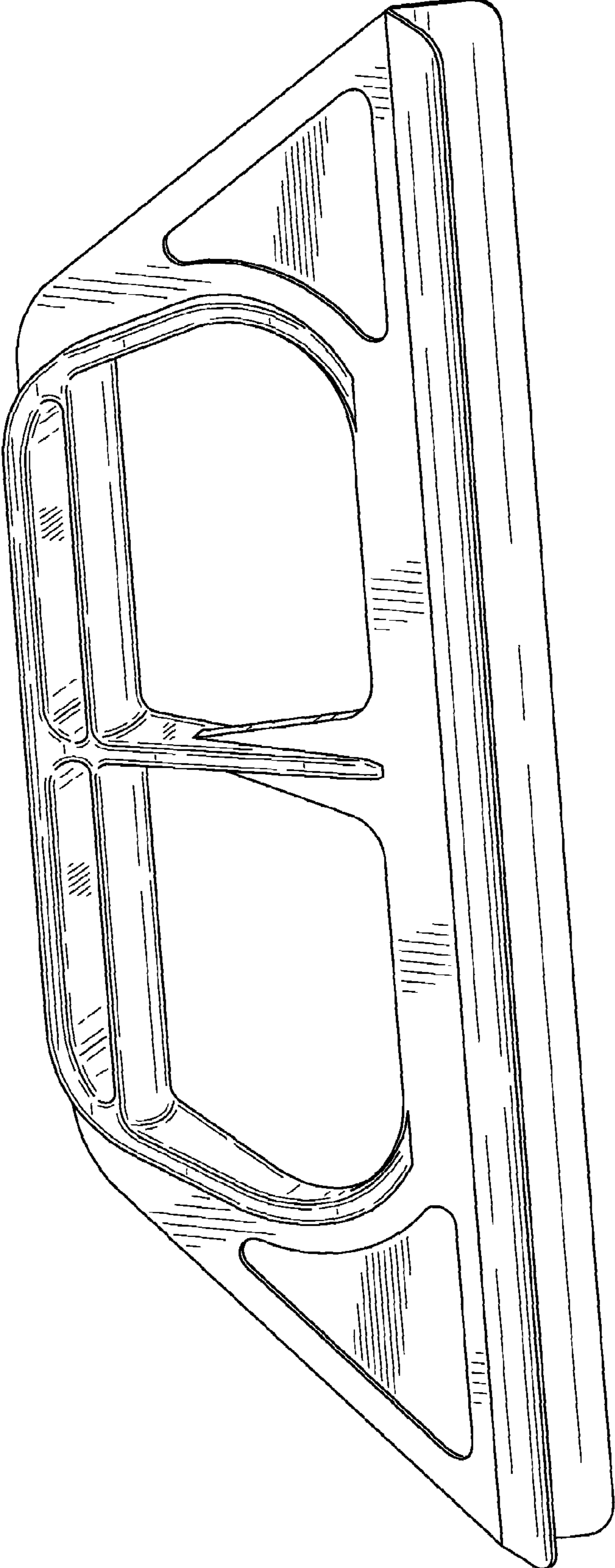

FIG. 2

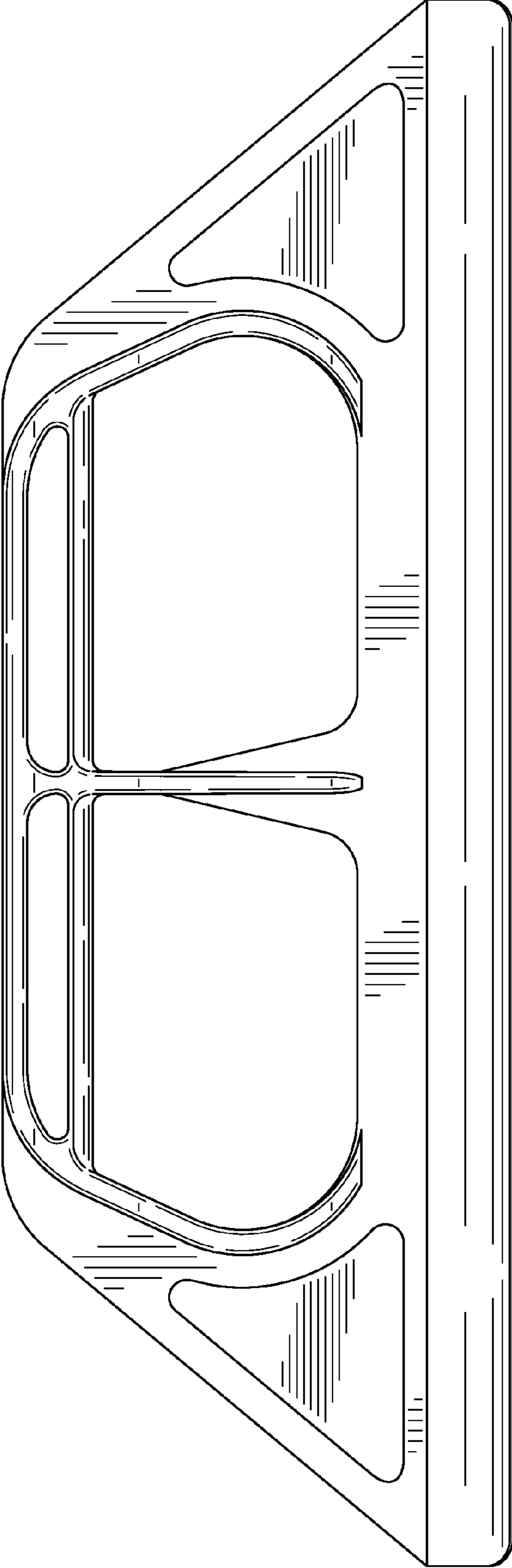

FIG. 3

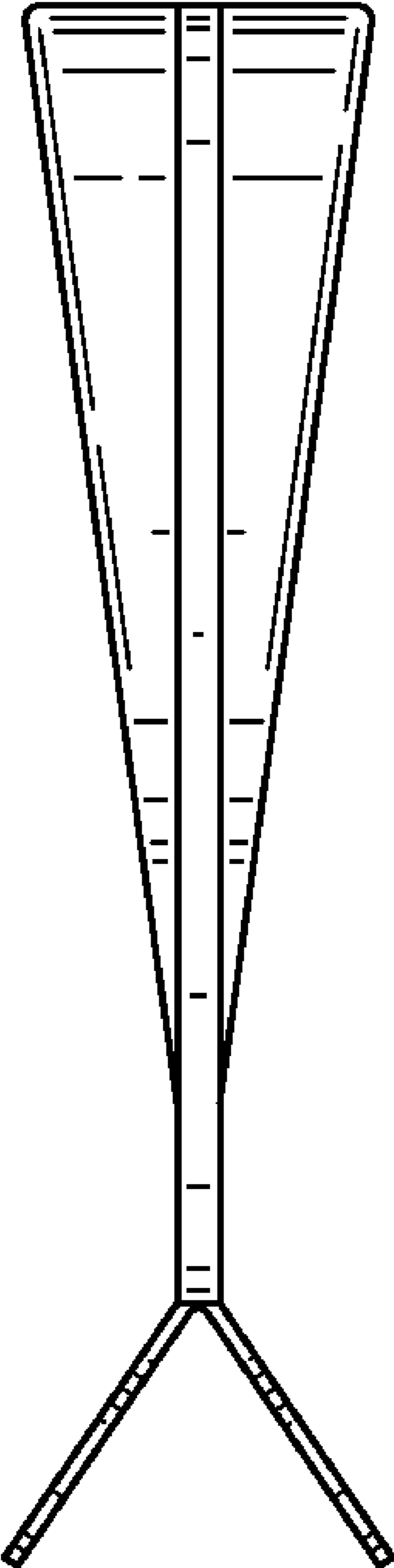

FIG. 4

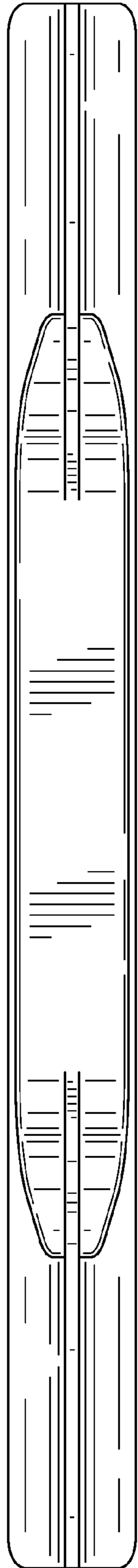

FIG. 5

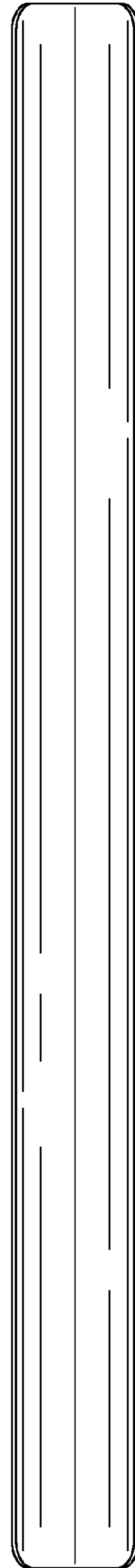

FIG. 6