



US00D608527S

(12) **United States Design Patent**
Chionna

(10) **Patent No.:** **US D608,527 S**
(45) **Date of Patent:** **** Jan. 26, 2010**

(54) **TROUSERS**

(76) Inventor: **Carlo Chionna**, Via Lemonia, 54, 40133 Bologna (IT)

(**) Term: **14 Years**

(21) Appl. No.: **29/312,143**

(22) Filed: **Oct. 1, 2008**

(30) **Foreign Application Priority Data**

Apr. 4, 2008 (EM) 000911623

(51) **LOC (9) Cl.** **02-02**

(52) **U.S. Cl.** **D2/742**

(58) **Field of Classification Search** D2/731,
D2/738, 742; 2/227, 228, 238

See application file for complete search history.

(56) **References Cited**

U.S. PATENT DOCUMENTS

6,421,831	B1 *	7/2002	Korff	2/69
D527,512	S *	9/2006	Chionna	D2/742
D537,237	S *	2/2007	Chionna	D2/742
D571,533	S *	6/2008	Wiens	D2/713
2006/0230488	A1 *	10/2006	Rudolph	2/69
2009/0038046	A1 *	2/2009	Moore et al.	2/67

FOREIGN PATENT DOCUMENTS

EP	1502513	A1 *	2/2005
FR	2873543	A1 *	2/2006
JP	2000045108	A *	2/2000

JP 2006219778 A * 8/2006

OTHER PUBLICATIONS

Raffaello Network. <http://www.raffaello-network.com/raffties/detail.php?itemid=73275&rangeid=841>. Fall-Winter 2006/07. 9.2 by Carlo Chionna Kids Clothing.*

Yoox. <http://www.yoox.com/item.asp?cod10=36129788&TP=11227>. Date Unknown: Viewed Apr. 2009. 9.2 by Carlo Chionna: Collection Yoox Printemps-Ete.*

Yoox. <http://www.yoox.com/item.asp?tskay=B490DC11&cod10=42127403&TP=1390>. Date Unknown: Viewed Apr. 2009. 9.2 by Carlo Chionna: Yoox-Kollektion: Fruhling-Sommer.*

* cited by examiner

Primary Examiner—Ian Simmons

Assistant Examiner—R. Johnson

(74) *Attorney, Agent, or Firm*—Fay Sharpe LLP

(57) **CLAIM**

The ornamental design for trousers, as shown and described.

DESCRIPTION

FIG. 1 is a front perspective view of trousers showing my new design,

FIG. 2 is a front view,

FIG. 3 is a right side view,

FIG. 4 is a rear view,

FIG. 5 is a left side view,

FIG. 6 is a top view; and,

FIG. 7 is a bottom view.

The broken lines in FIGS. 1–7 represent stitching.

1 Claim, 4 Drawing Sheets

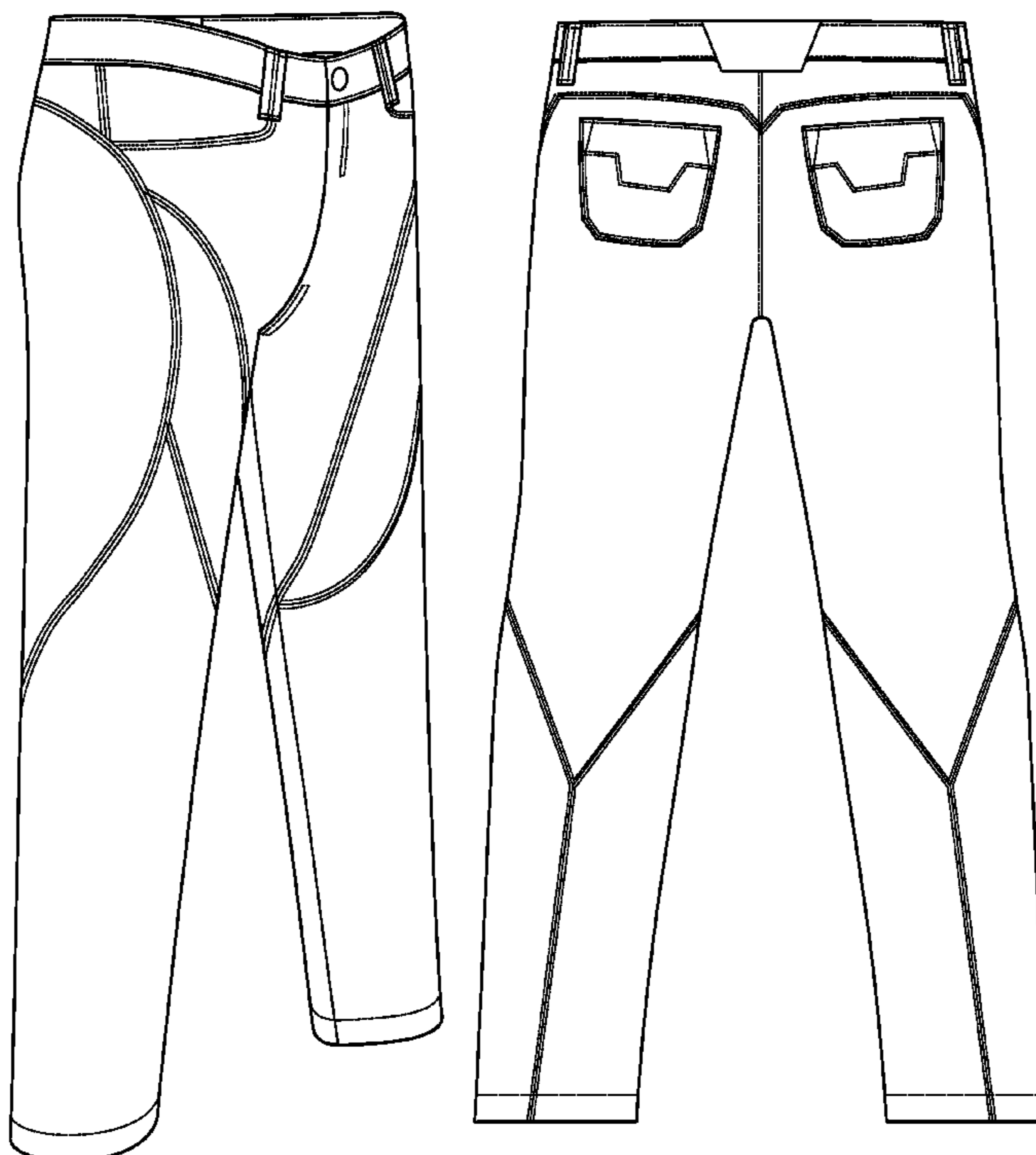

FIG. 1

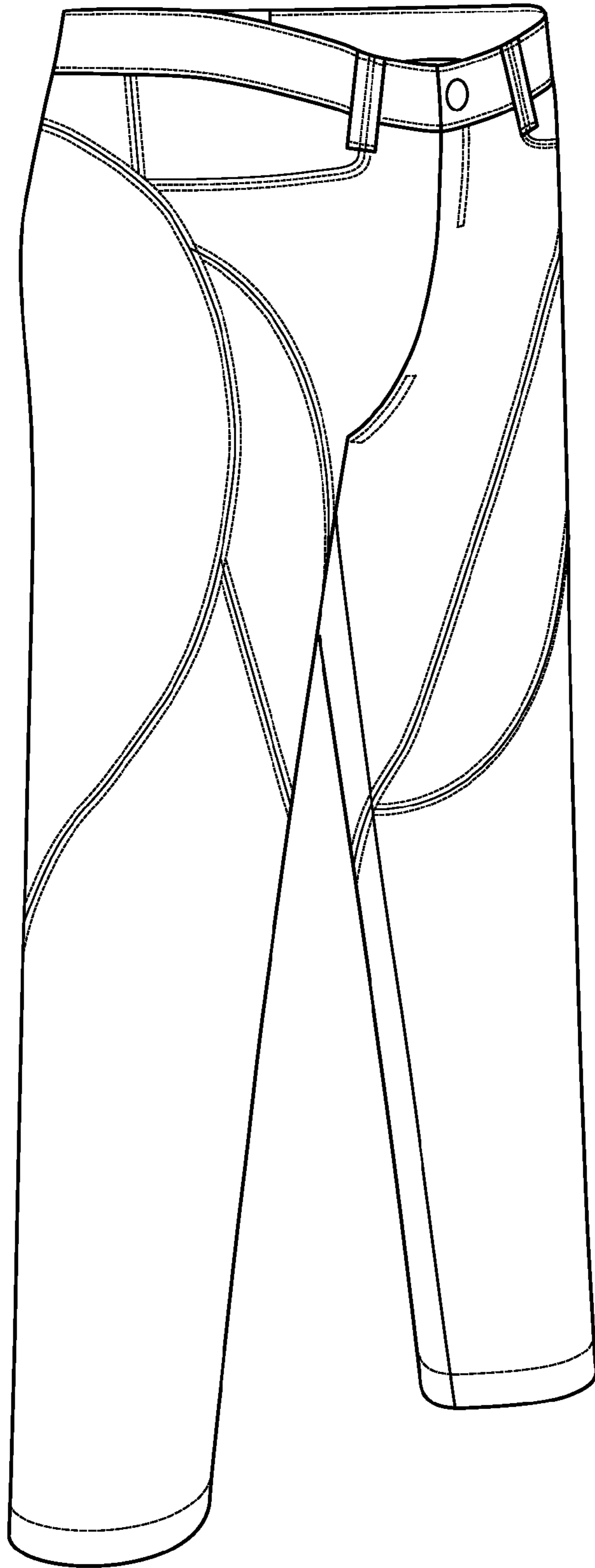

FIG.2

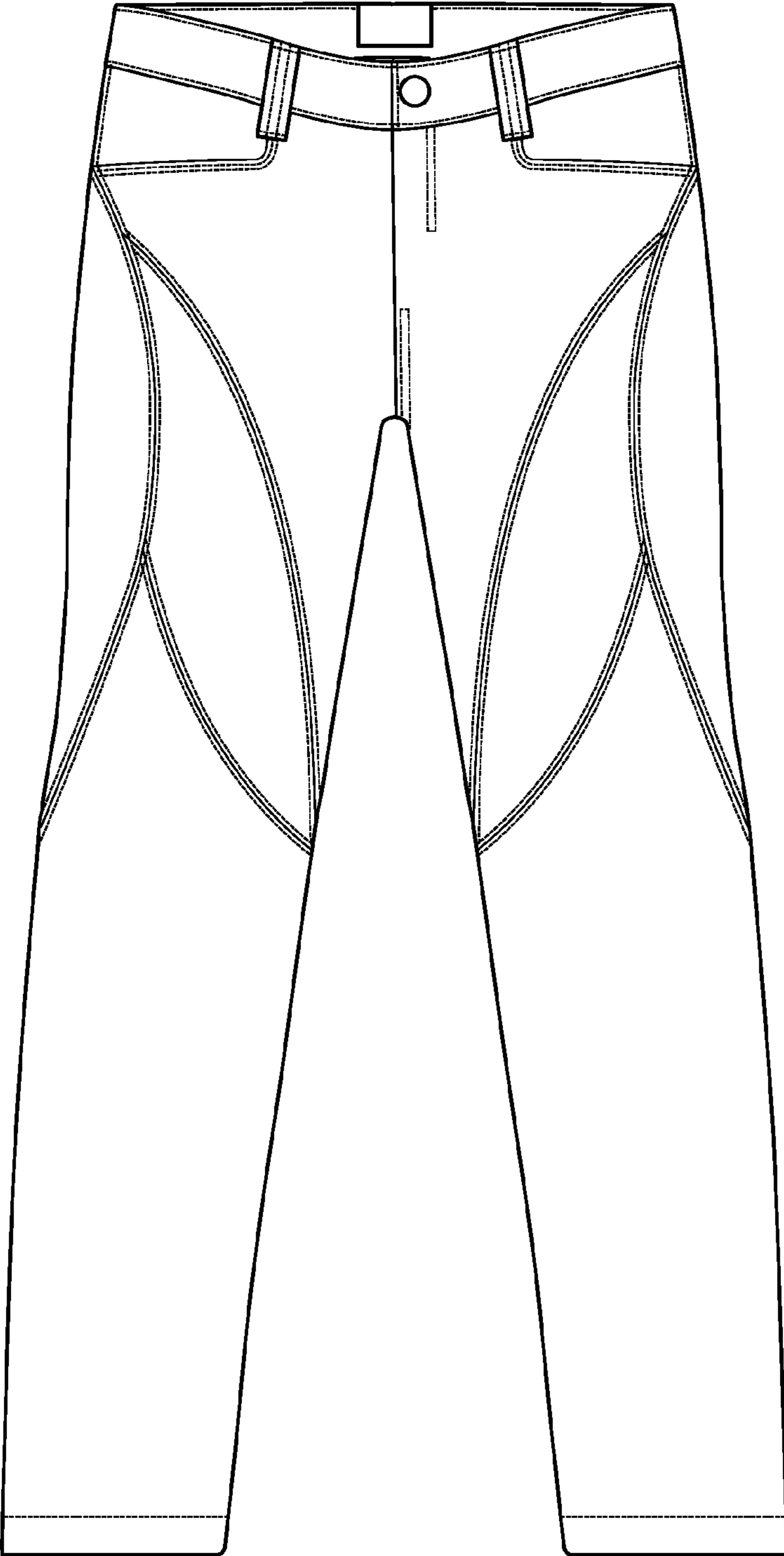

FIG.3

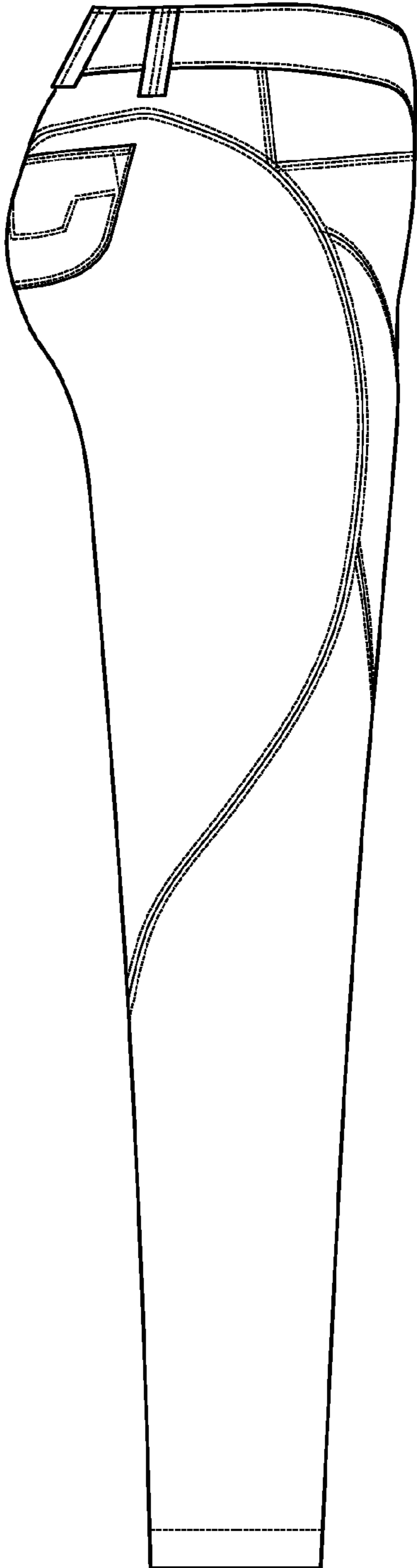

FIG.4

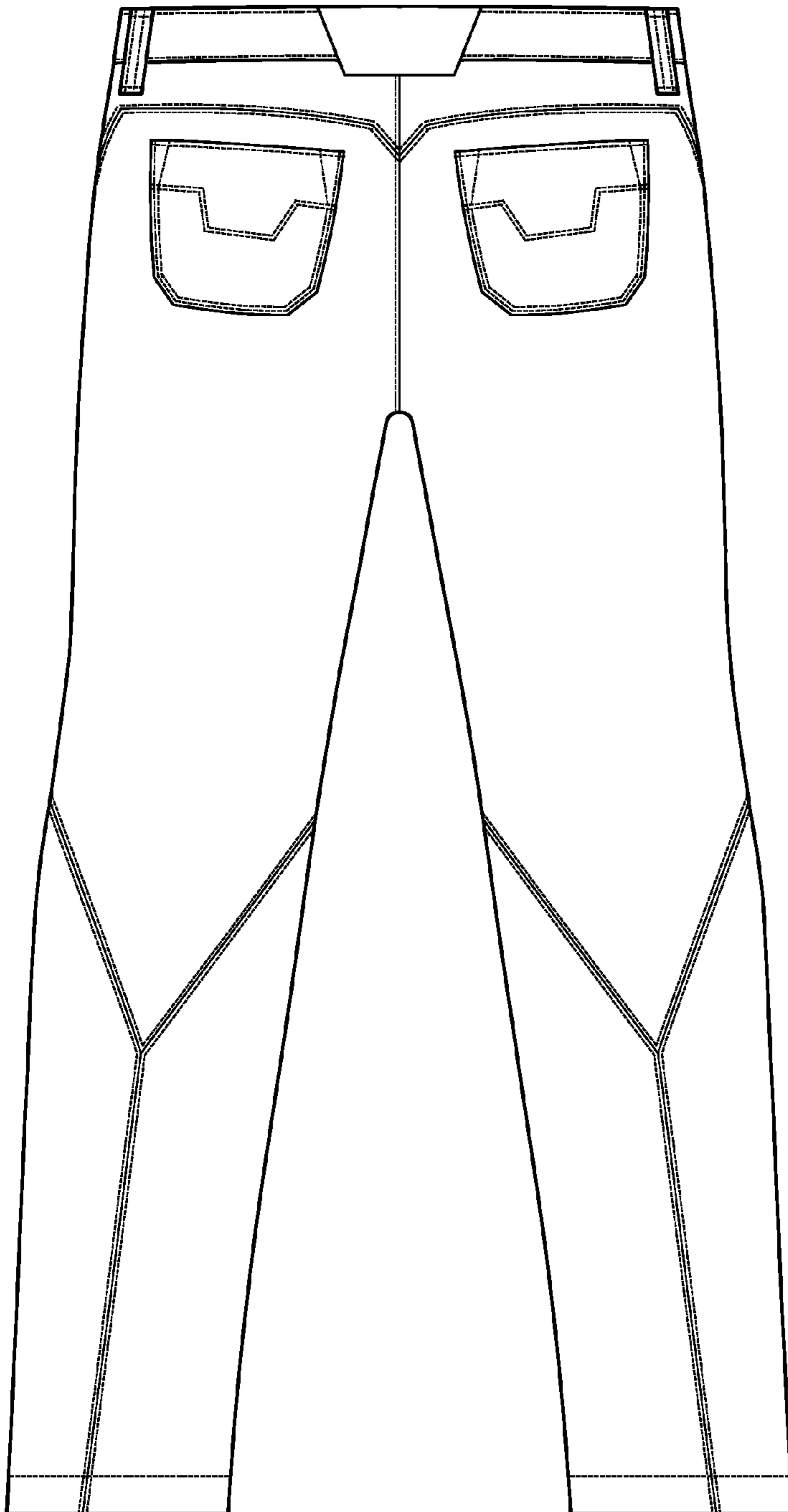

FIG.5

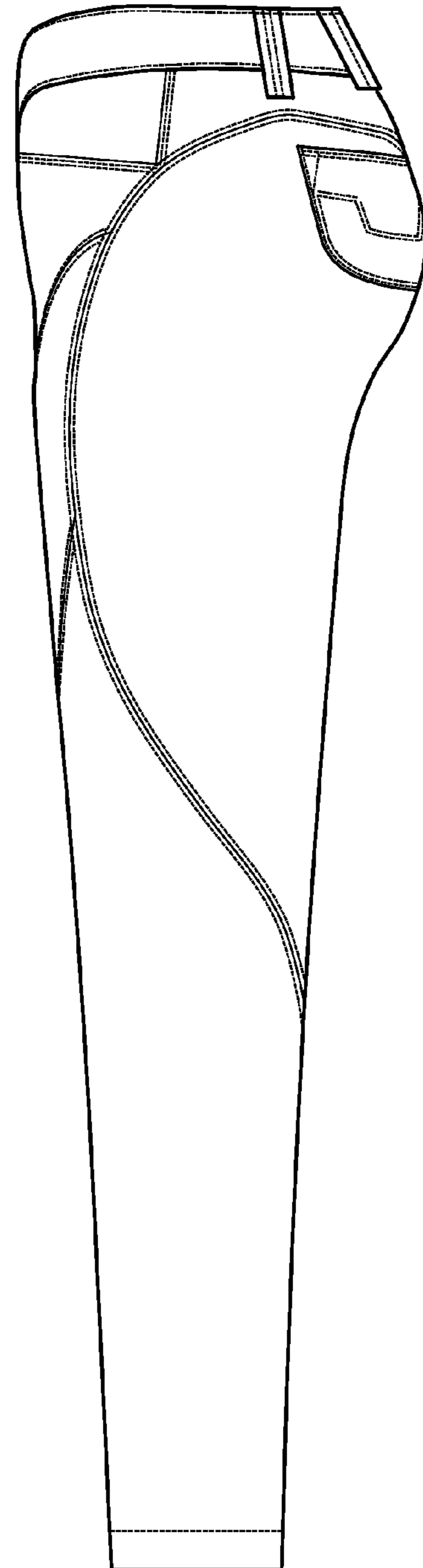

FIG. 6

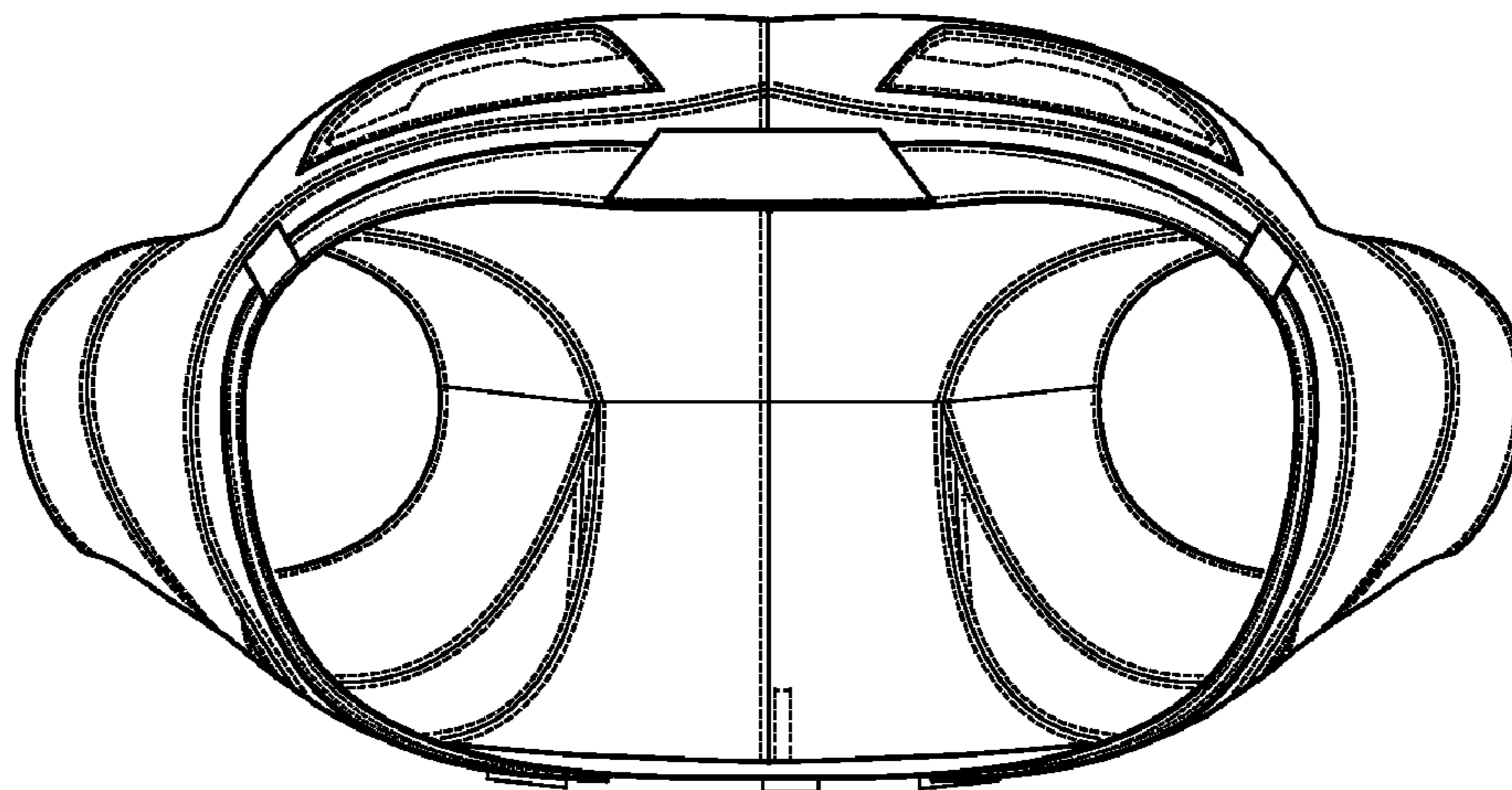

FIG. 7

