



US00D608520S

(12) **United States Design Patent**
Fick et al.

(10) **Patent No.:** **US D608,520 S**
(45) **Date of Patent:** **** Jan. 19, 2010**

(54) **RIDING MOWER RAMP**

- (75) Inventors: **Orval Lee Fick**, Miami, OK (US);
Mark H. Bennett, Miami, OK (US)
- (73) Assignee: **Blitz U.S.A., Inc.**, Miami, OK (US)
- (**) Term: **14 Years**
- (21) Appl. No.: **29/326,559**
- (22) Filed: **Oct. 20, 2008**
- (51) **LOC (9) Cl.** **12-05**
- (52) **U.S. Cl.** **D34/32**
- (58) **Field of Classification Search** D34/32,
D34/33, 28; D15/17; D12/217; 81/8, 15;
254/88; 14/69.5, 71.1, 71.5; 152/213 R
See application file for complete search history.

(56) **References Cited**

U.S. PATENT DOCUMENTS

1,689,475	A *	10/1928	Brumder	473/184
1,947,346	A	1/1934	Lintem	
2,712,432	A	7/1955	Thornton, Jr.	
3,512,613	A	5/1970	Peterson	
3,684,233	A	8/1972	Vukich	
3,879,014	A	4/1975	Larson	
4,034,961	A	7/1977	Breen	
D257,874	S *	1/1981	Sheehan et al.	D21/817
4,877,211	A	10/1989	Orr	
5,033,146	A *	7/1991	Fogarty et al.	14/69.5
D347,502	S *	5/1994	Mazza	D34/32
D347,503	S *	5/1994	Wallace et al.	D34/32

(Continued)

OTHER PUBLICATIONS

California Car Cover Co. catalog, front and back covers, p. 46 (2004).

Primary Examiner—Stella M Reid

Assistant Examiner—Mark A Goodwin

(74) *Attorney, Agent, or Firm*—Hovey Williams LLP

(57) **CLAIM**

The ornamental design for a riding mower ramp, as shown and described.

DESCRIPTION

FIG. 1 is a top perspective view of a riding mower ramp showing our new design, with the projections on the upper tire-engaging surface, the ground-engaging flange, the nesting sockets, and the traction-enhancing features being shown in broken lines for illustrative purposes only and forming no part of the claimed design;

FIG. 2 is a bottom perspective view of the riding mower ramp depicted in FIG. 1, with the internal spacing walls and a number of other constructional details being shown in broken lines for illustrative purposes only and forming no part of the claimed design;

FIG. 3 is a right side elevation view of the riding mower ramp depicted in FIGS. 1 and 2, with the left side elevation being a mirror image thereof;

FIG. 4 is a front elevation view thereof;

FIG. 5 is a rear elevation view thereof;

FIG. 6 is a top elevation view thereof;

FIG. 7 is a bottom elevation view thereof;

FIG. 8 is a top perspective view of a second embodiment of a riding mower ramp showing our new design, with the projections on the upper tire-engaging surface, the ground-engaging flange, the nesting sockets, and the traction-enhancing features being shown in broken lines for illustrative purposes only and forming no part of the claimed design;

FIG. 9 is a bottom perspective view of the riding mower ramp depicted in FIG. 8, with the internal spacing walls and a number of other constructional details being shown in broken lines for illustrative purposes only and forming no part of the claimed design;

FIG. 10 is a right side elevation view of the riding mower ramp depicted in FIGS. 8 and 9, with the left side elevation being a mirror image thereof;

FIG. 11 is a front elevation view thereof;

FIG. 12 is a rear elevation view thereof;

FIG. 13 is a top elevation view thereof; and,

FIG. 14 is a bottom elevation view thereof.

1 Claim, 14 Drawing Sheets

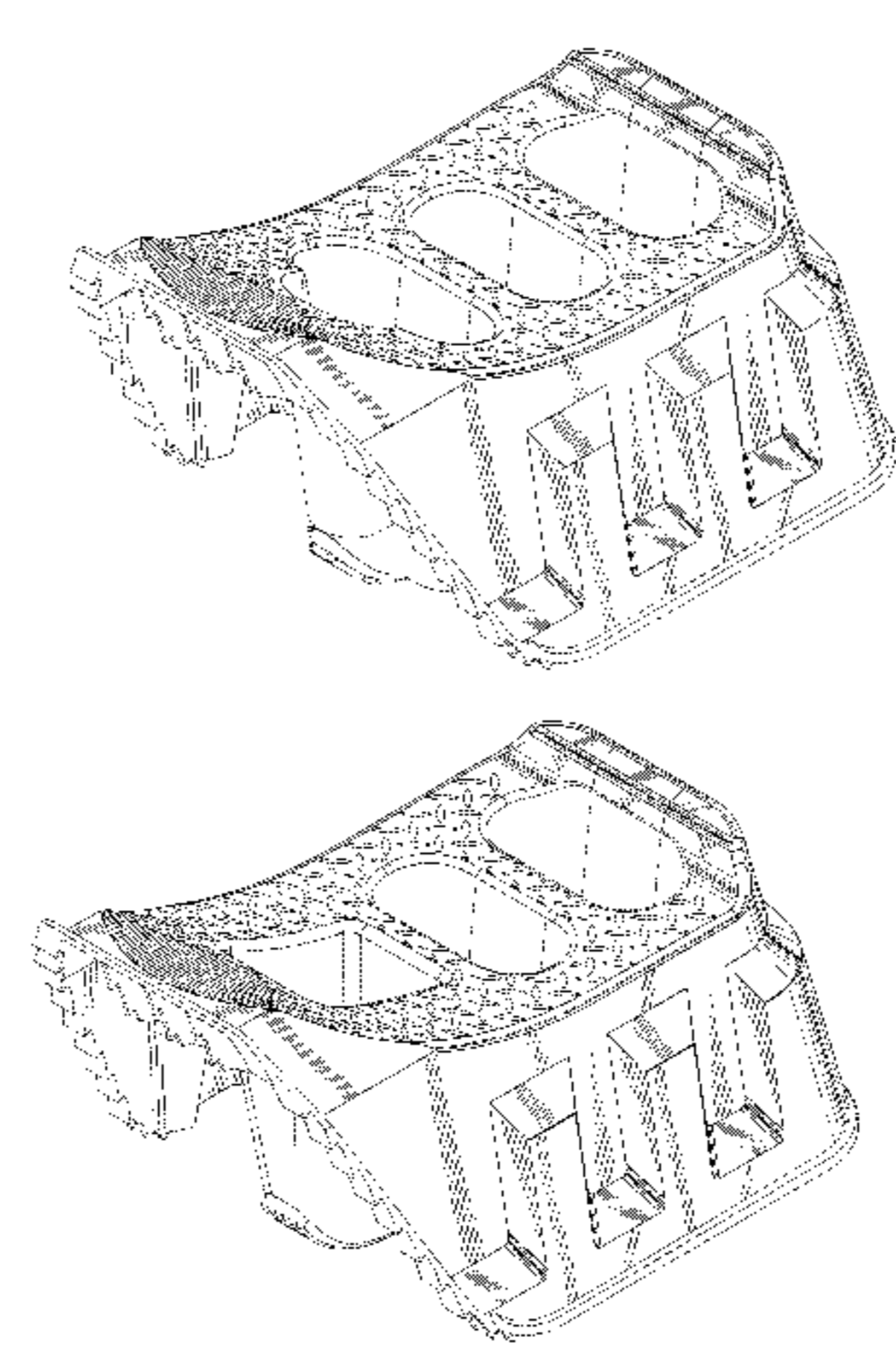

US D608,520 S

Page 2

U.S. PATENT DOCUMENTS

D351,710 S *	10/1994	Richardson	D34/32	7,000,740 B2	2/2006	Chrisco et al.	
RE034,889 E	4/1995	Fogarty et al.			7,003,836 B2 *	2/2006	Berg 14/69.5
D365,908 S *	1/1996	Pesznecker	D34/32	D520,438 S *	5/2006	Colak et al. D12/217
5,483,715 A *	1/1996	Fogarty et al.	14/69.5	7,040,461 B2	5/2006	Chrisco et al.	
D386,462 S *	11/1997	McCune et al.	D12/217	D524,222 S	7/2006	Chrisco et al.	
D388,927 S *	1/1998	Morgan	D34/32	7,104,524 B1 *	9/2006	Hidding et al. 254/88
D477,045 S *	7/2003	Rieber et al.	D21/811	D542,876 S *	5/2007	Laurienzo et al. D21/817
RE38,326 E *	11/2003	Mapp	14/69.5	D543,675 S *	5/2007	Ji D34/32
D493,408 S	7/2004	Chrisco et al.			7,278,627 B2	10/2007	Jones	
D500,113 S *	12/2004	Frey et al.	D21/817	D567,471 S *	4/2008	Haimoff D34/33
D500,829 S *	1/2005	Hadley	D21/817	D577,651 S *	9/2008	Shaw D12/217
D500,979 S	1/2005	Chrisco et al.			D592,823 S *	5/2009	Weger D34/33
D502,139 S	2/2005	Chrisco et al.			D595,920 S *	7/2009	Lederhause et al. D34/32
					D596,368 S *	7/2009	Holicki D34/32

* cited by examiner

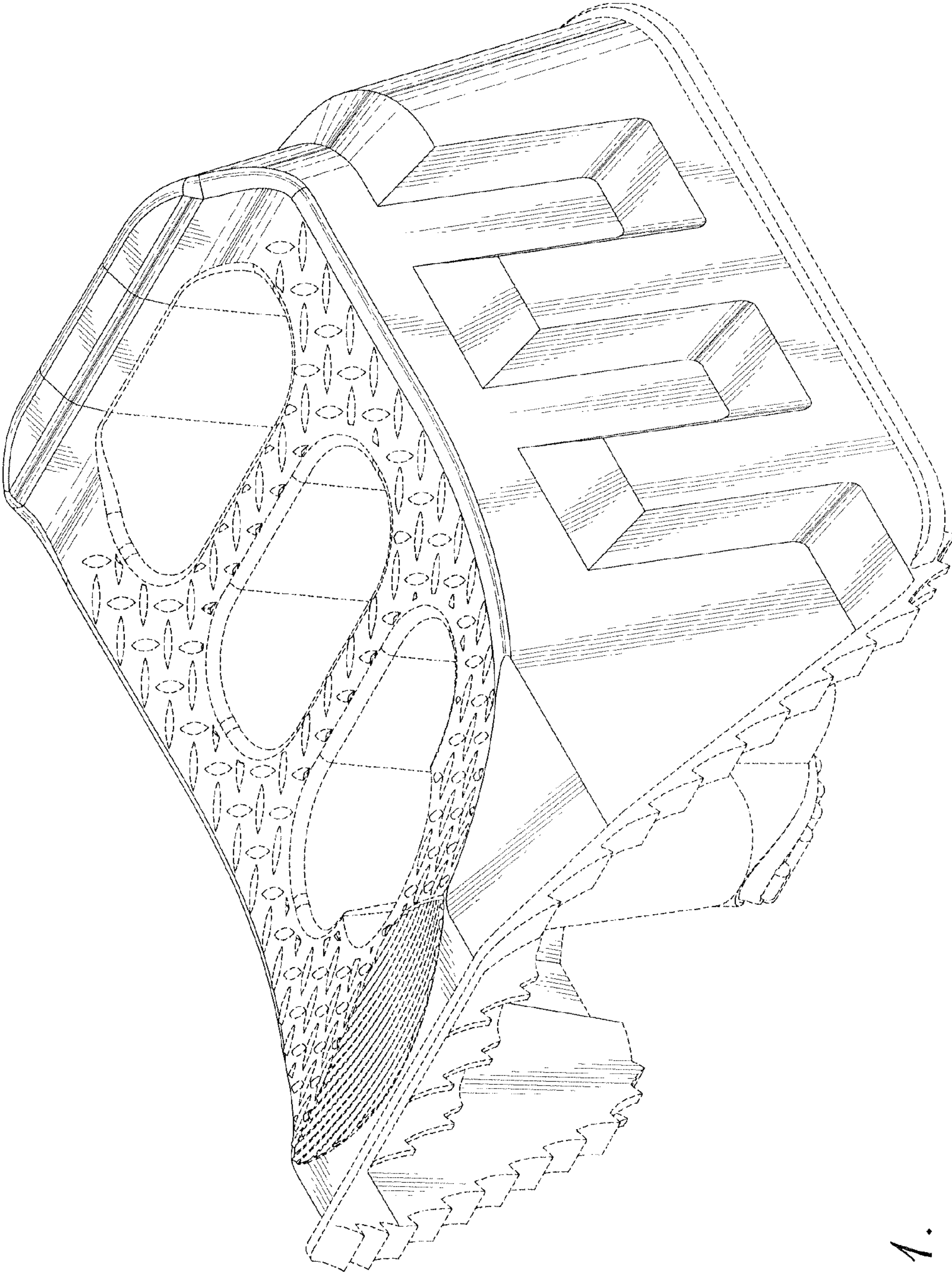

Fig. 1.

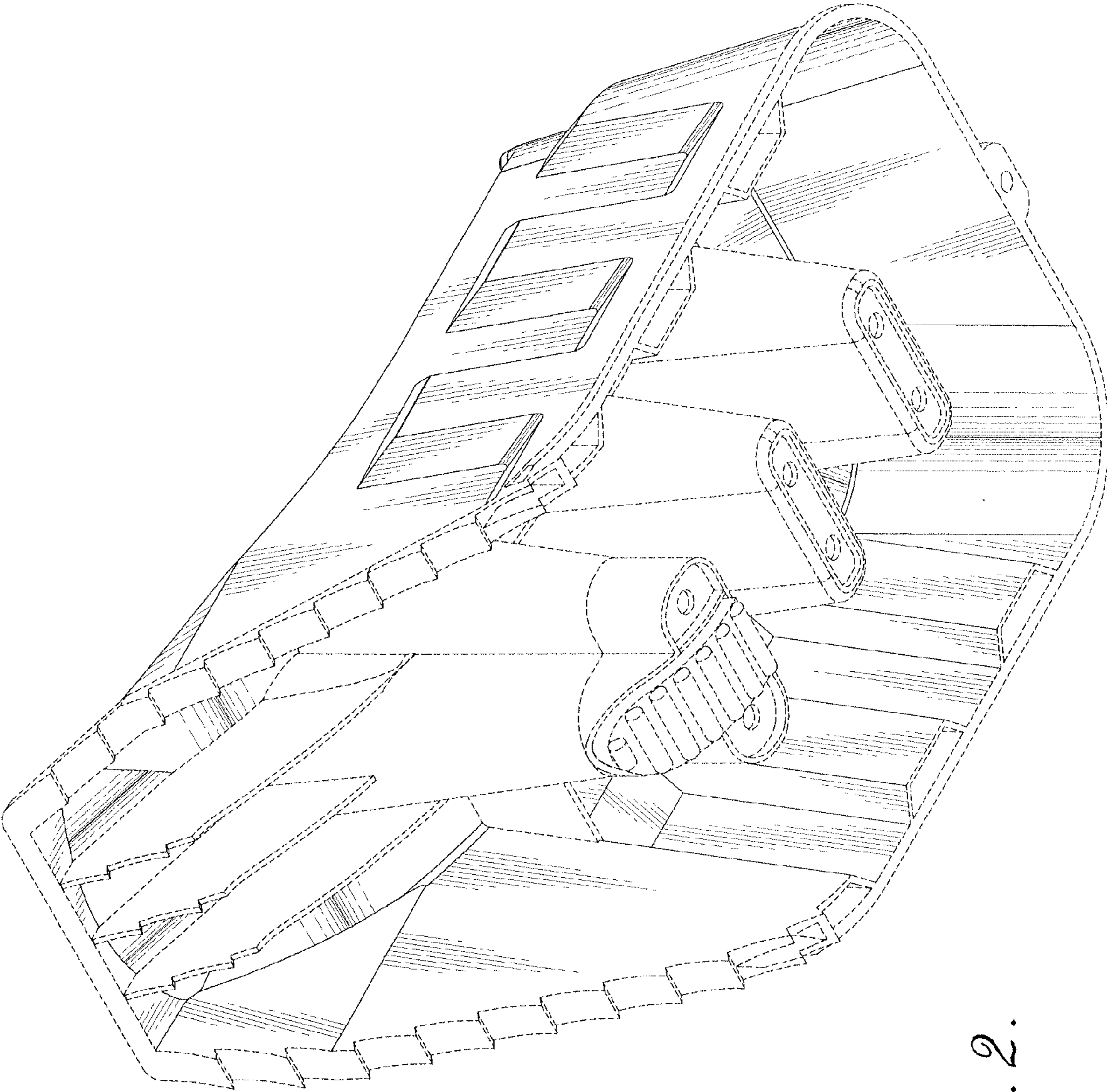

Fig. 2.

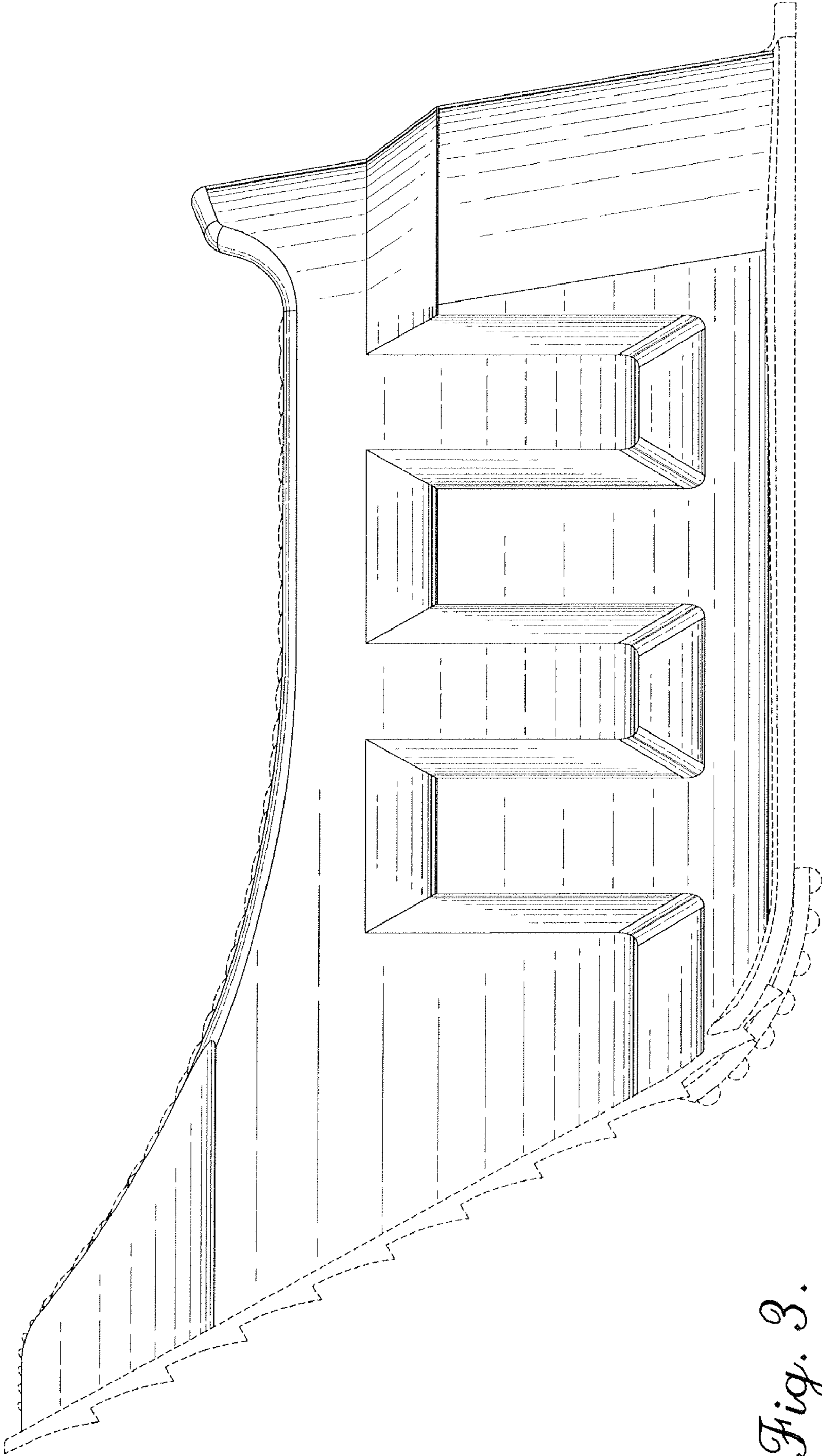

Fig. 3.

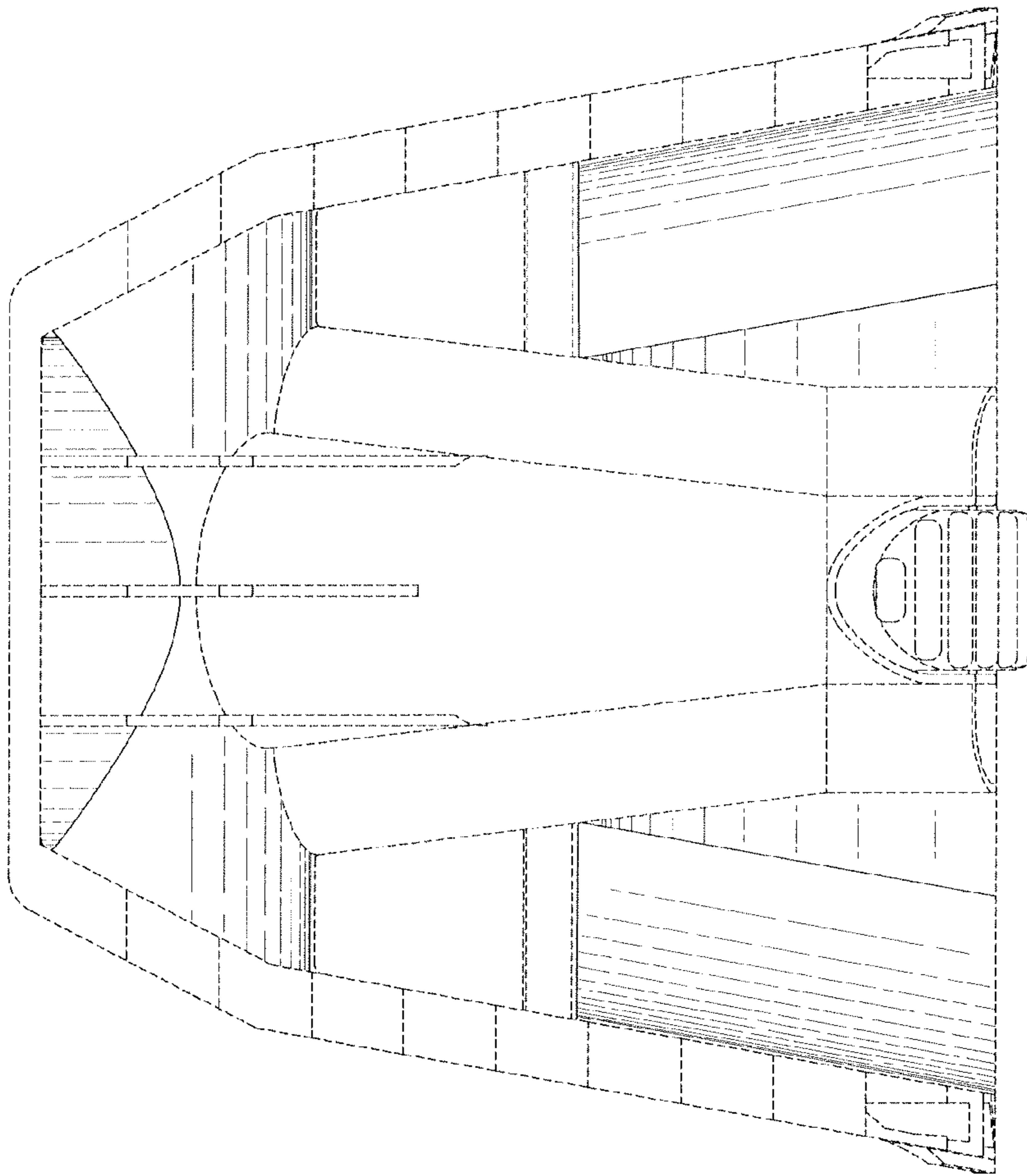

Fig. 4.

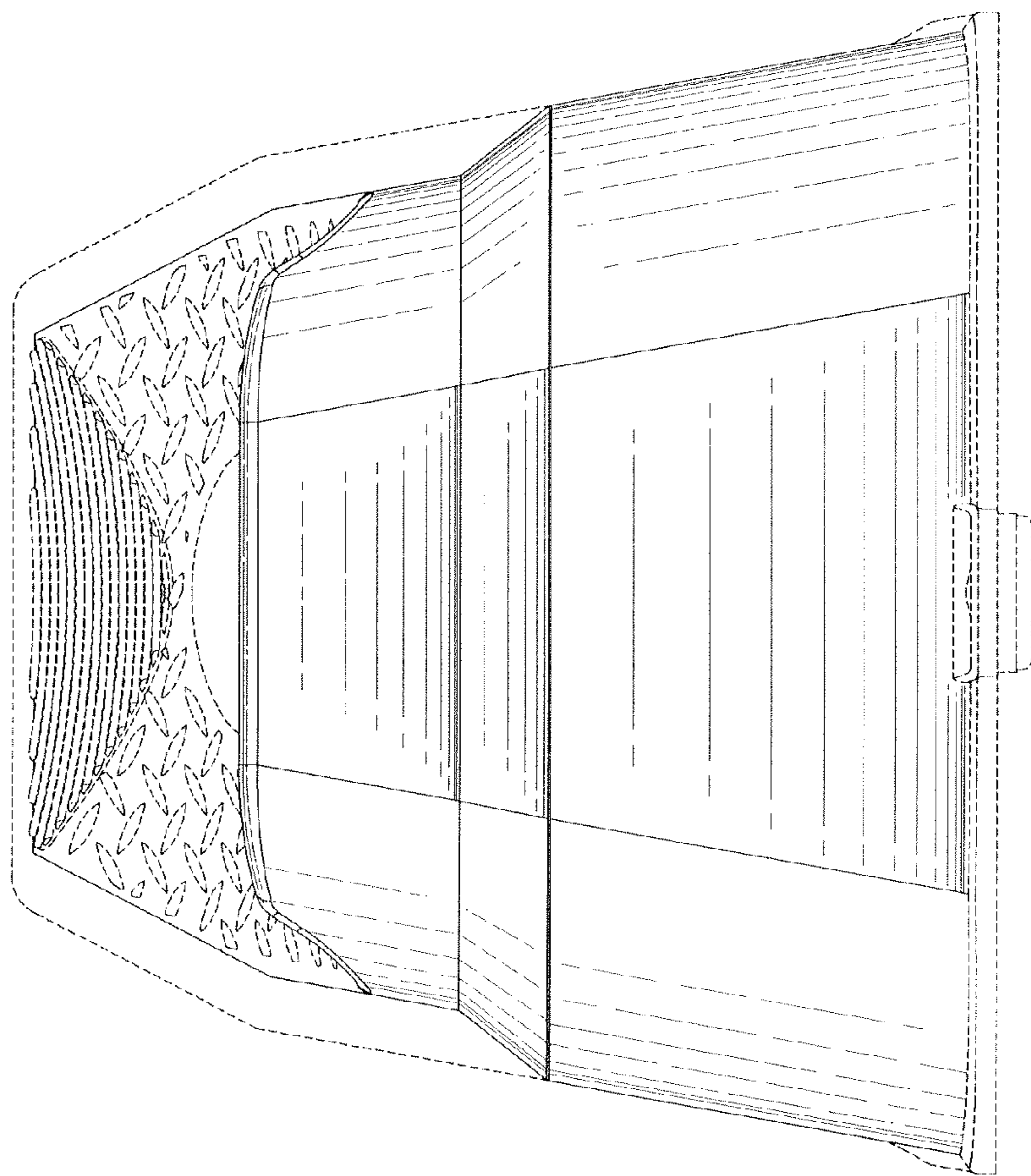

Fig. 5.

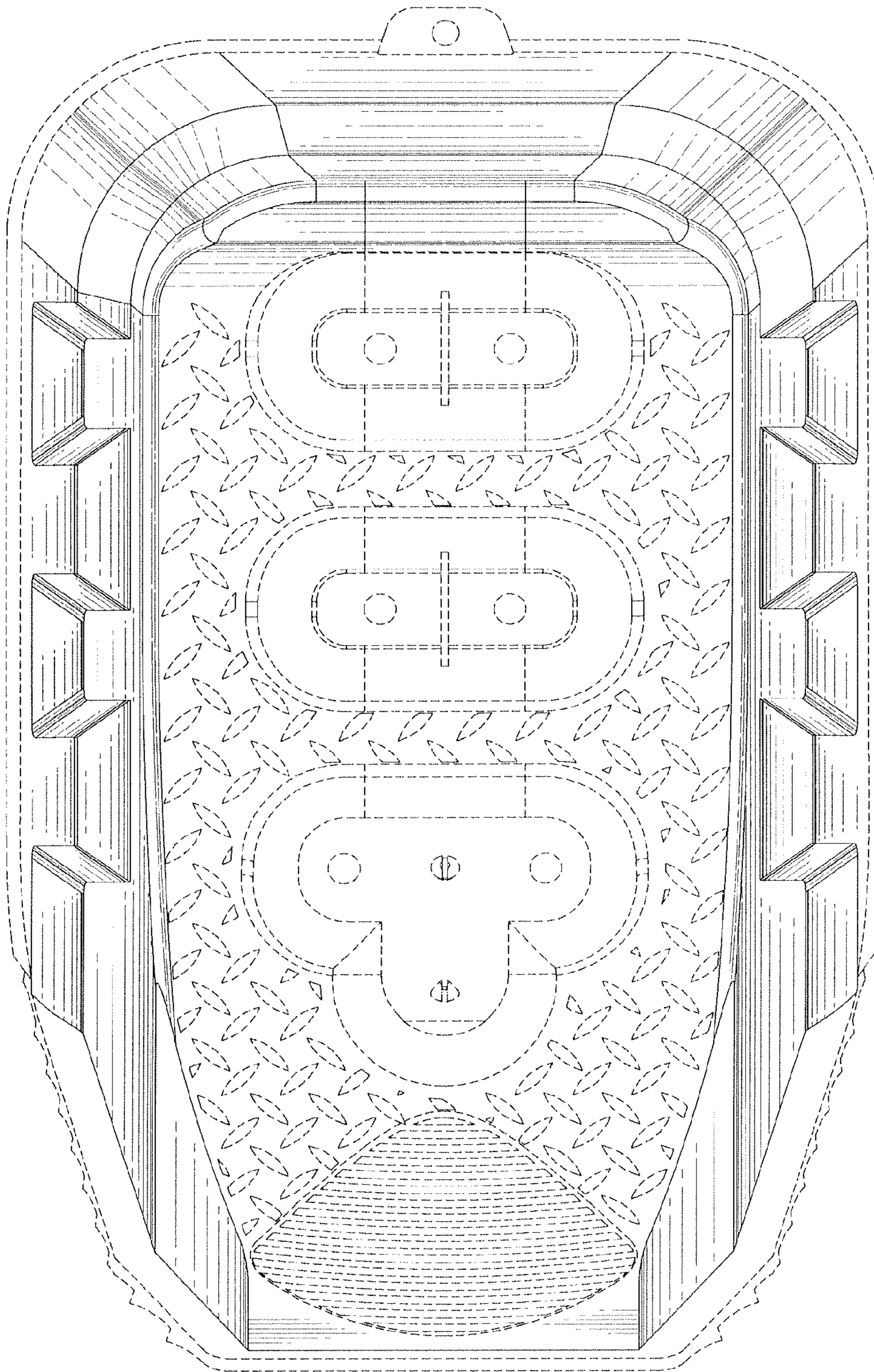

Fig. 6.

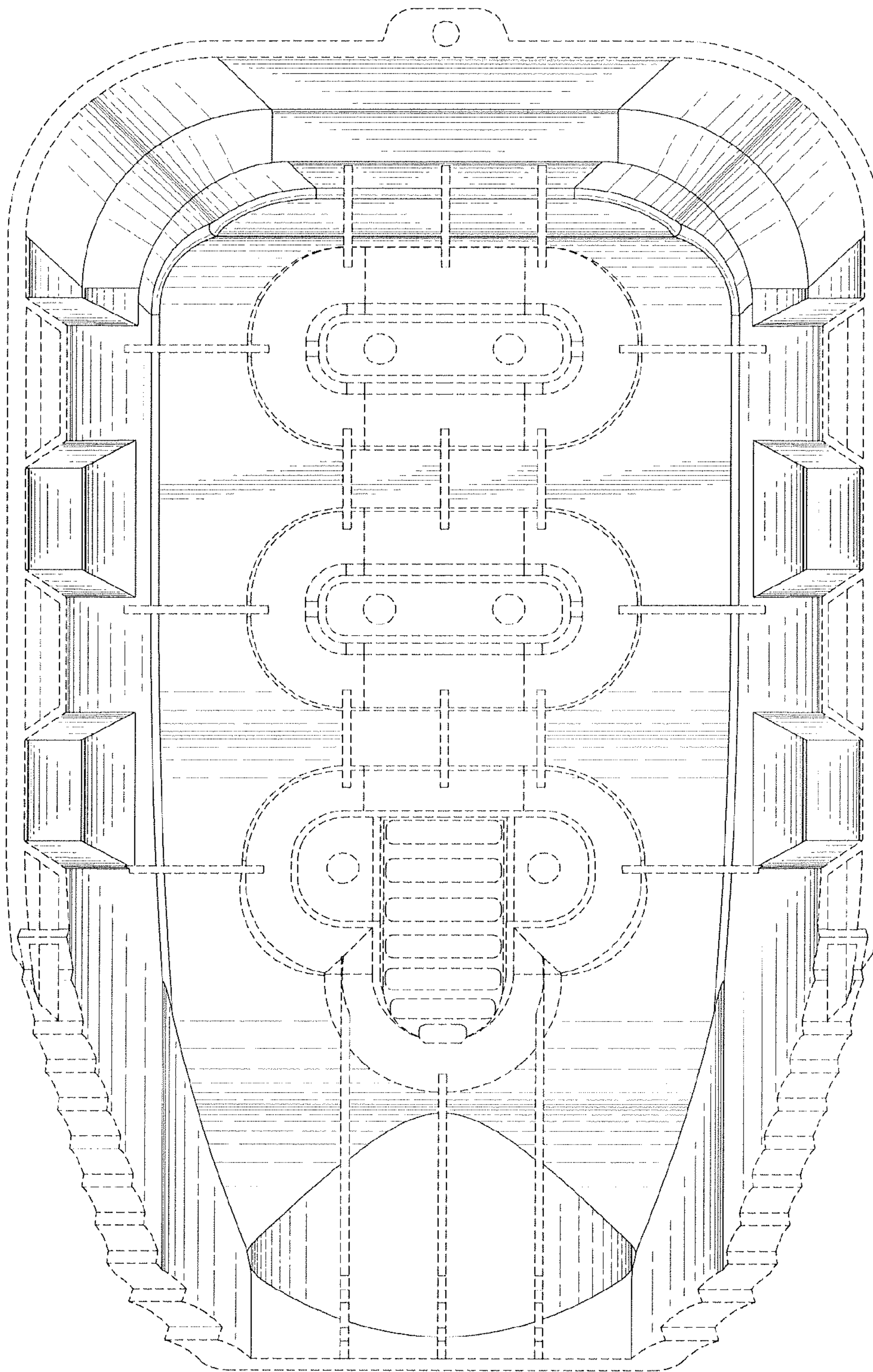

Fig. 7.

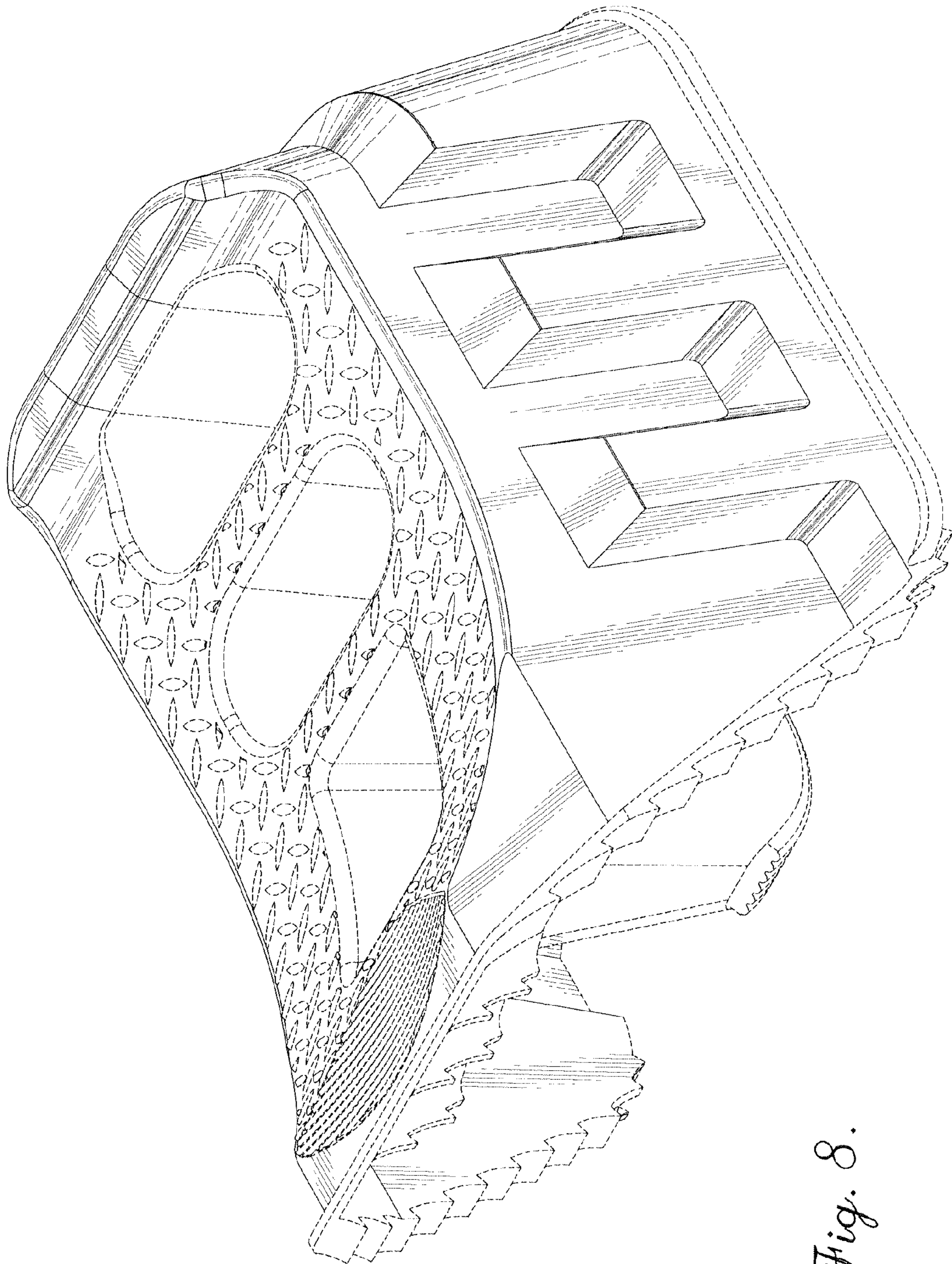

Fig. 8.

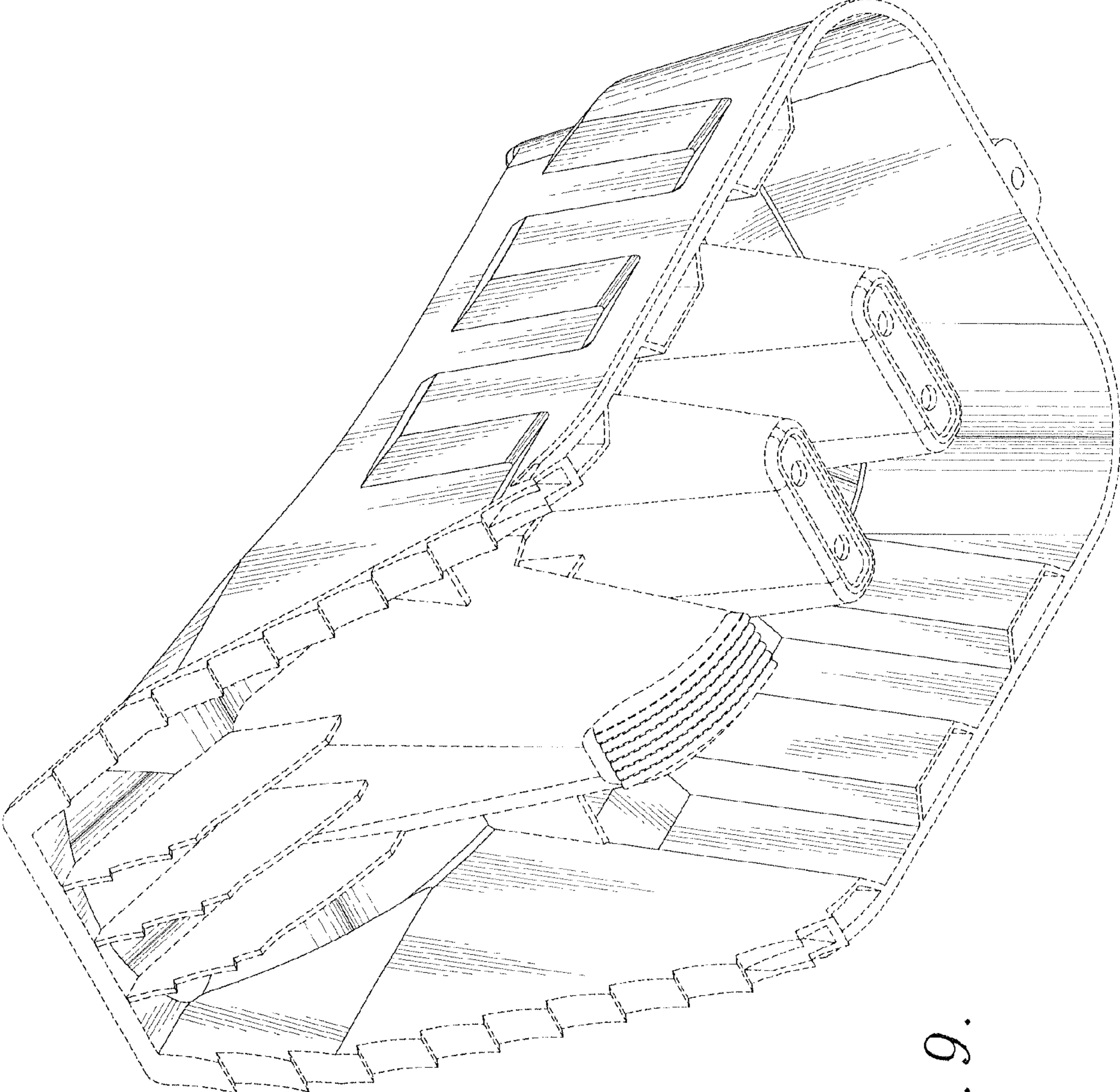

Fig. 9.

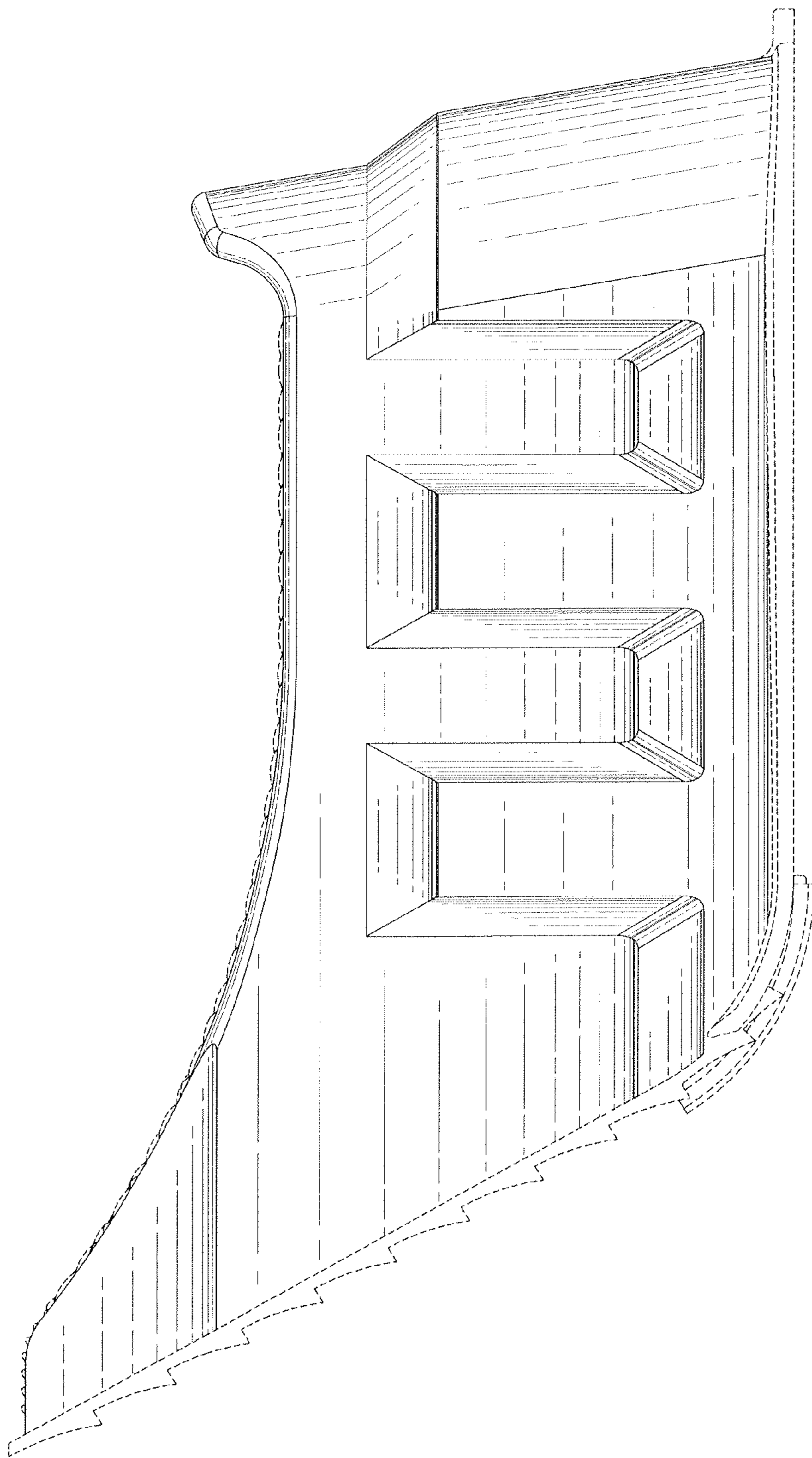

Fig. 10.

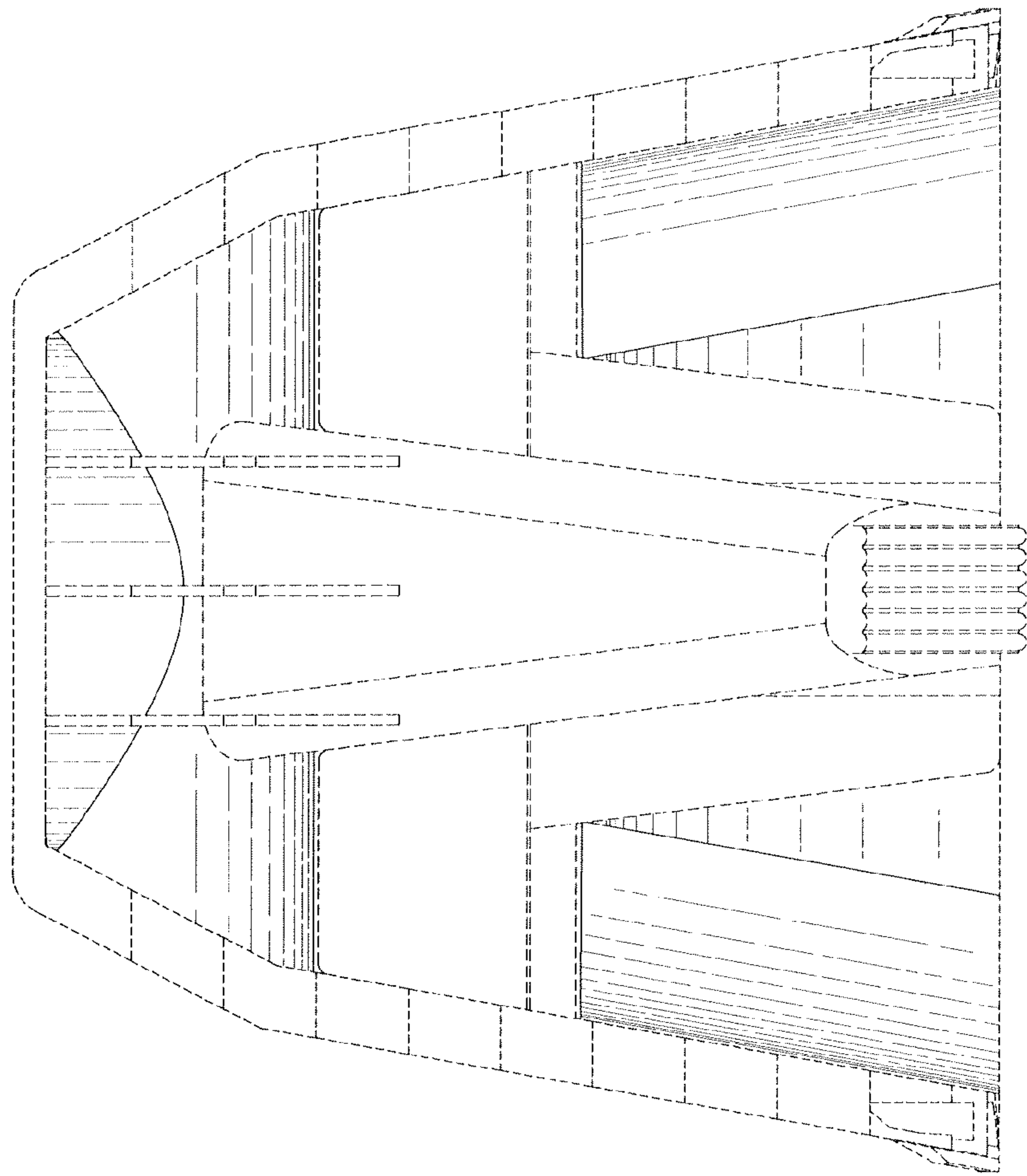

Fig. 11.

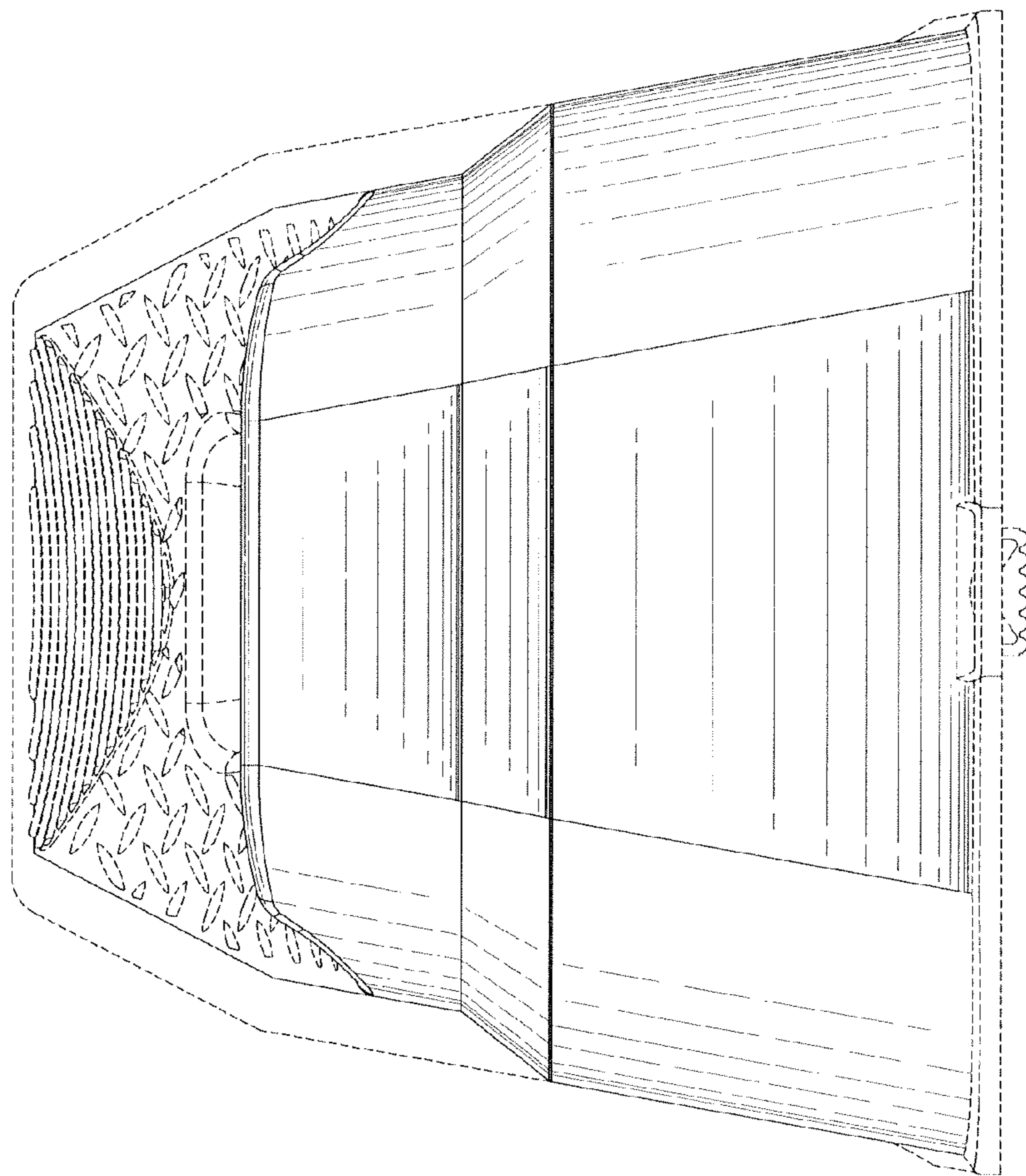

Fig. 12.

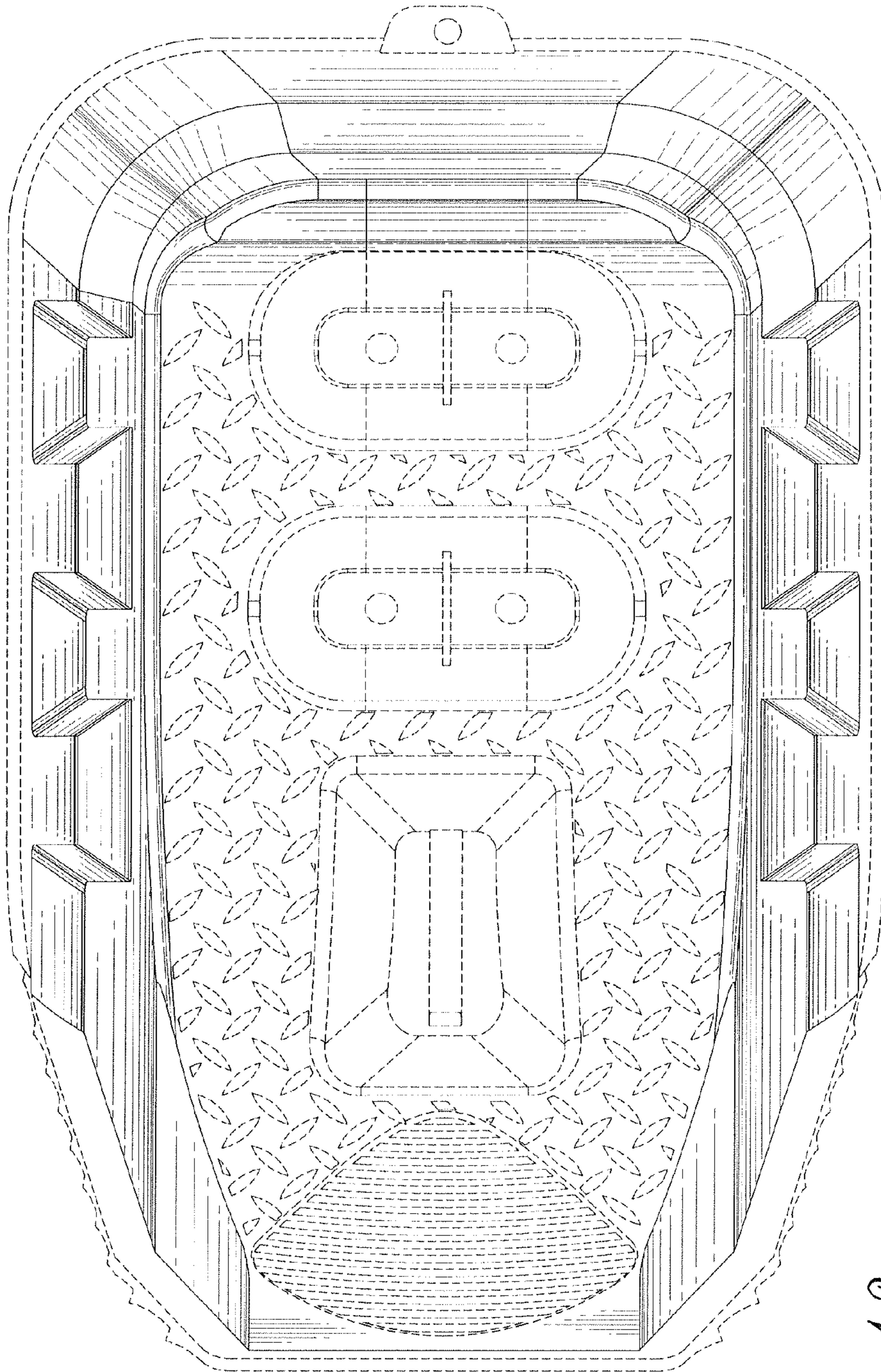

Fig. 13.

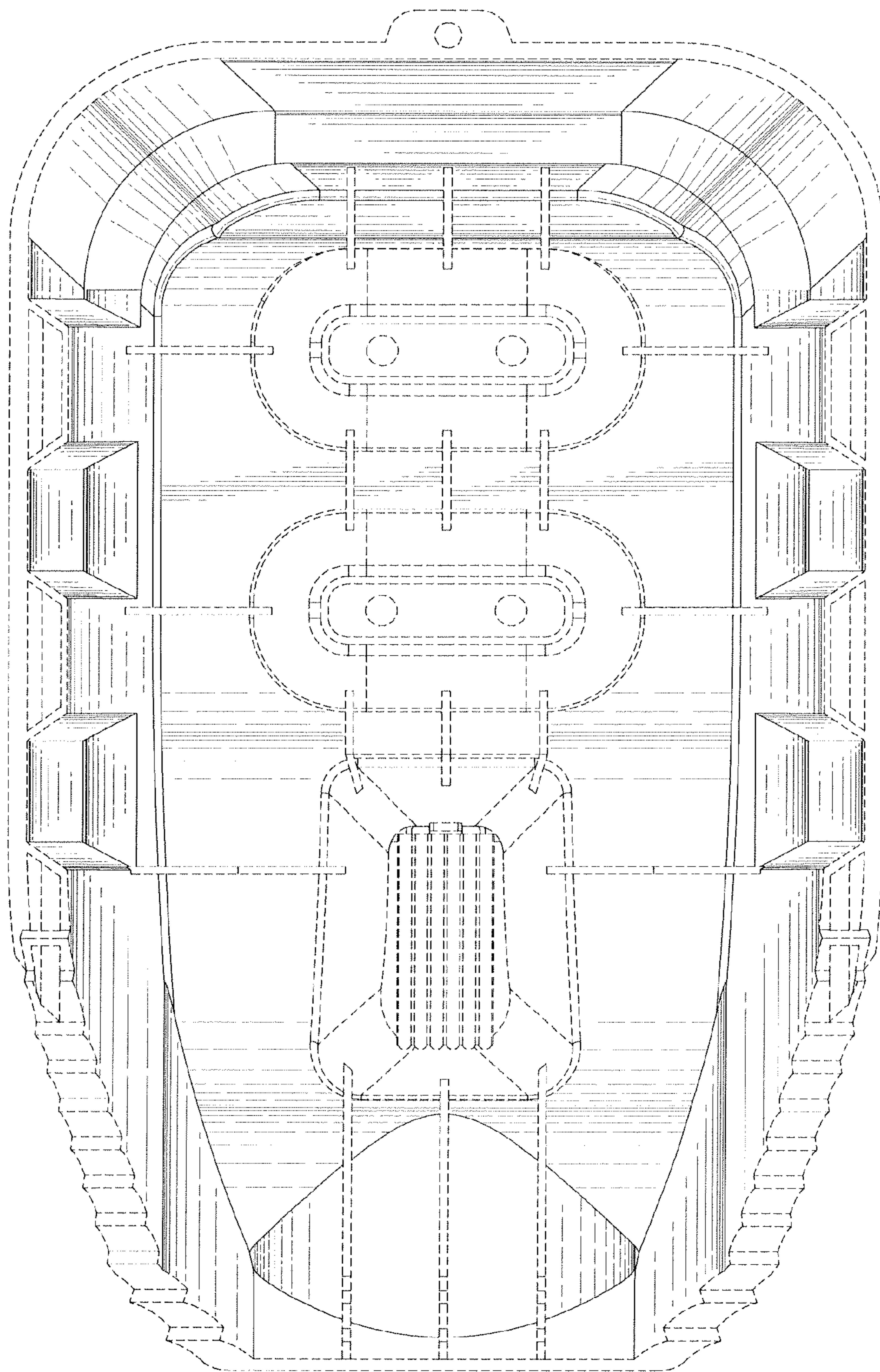

Fig. 14.