



US00D608293S

(12) **United States Design Patent**
Ngo

(10) **Patent No.:** **US D608,293 S**
(45) **Date of Patent:** **** Jan. 19, 2010**

(54) **VERTICAL ELECTRICAL CONNECTOR**
(75) Inventor: **Hung Viet Ngo**, Harrisburg, PA (US)
(73) Assignee: **FCI Americas Technology, Inc.**, Carson City, NV (US)
(**) Term: **14 Years**
(21) Appl. No.: **29/331,013**
(22) Filed: **Jan. 16, 2009**
(51) **LOC (9) Cl.** **13-03**
(52) **U.S. Cl.** **D13/147; D13/154**
(58) **Field of Classification Search** D13/133, D13/146-147, 154, 184, 199; 439/64, 79, 439/159-160, 260, 325, 329, 395, 492, 495, 439/607-610, 630
See application file for complete search history.

3,871,015 A 3/1975 Lin et al.
(Continued)

FOREIGN PATENT DOCUMENTS
DE 1 665 181 4/1974
(Continued)

OTHER PUBLICATIONS
Finan, J.M., "Thermally Conductive Thermoplastics", LNP Engineering Plastics, Inc., Plastics Engineering 2000, www.4spe.org, 4 pages.
(Continued)

Primary Examiner—Daniel D Bui
(74) *Attorney, Agent, or Firm*—Woodcock Washburn LLP

(56) **References Cited**
U.S. PATENT DOCUMENTS

318,186 A	5/1885	Hertzog
741,052 A	10/1903	Mahon
1,477,527 A	12/1923	Raettig
2,248,675 A	7/1941	Huppert
2,430,011 A	11/1947	Gillentine
2,759,163 A	8/1956	Ustin et al.
2,762,022 A	9/1956	Benander et al.
2,844,644 A	7/1958	Soule, Jr.
3,011,143 A	11/1961	Dean
3,178,669 A	4/1965	Roberts
3,208,030 A	9/1965	Evans et al.
3,286,220 A	11/1966	Marley et al.
3,411,127 A	11/1968	Adams
3,420,087 A	1/1969	Hatfield et al.
3,514,740 A	5/1970	Filson et al.
3,538,486 A	11/1970	Shlesinger, Jr.
3,634,811 A	1/1972	Teagno
3,669,054 A	6/1972	Desso et al.
3,692,994 A	9/1972	Hirschmann et al.
3,748,633 A	7/1973	Lundergan
3,845,451 A	10/1974	Neidecker

(57) **CLAIM**

The ornamental design for a vertical electrical connector, as shown and described.

DESCRIPTION

In a preferred embodiment, the nature of this product is a vertical electrical connector in the form of an electrical connector housing configured for retaining a plurality of electrical contacts.

FIG. 1 is a top, left, rear perspective view of a vertical electrical connector according to my design;

FIG. 2 is a top plan view thereof;

FIG. 3 is a bottom plan view thereof;

FIG. 4 is a rear elevation view thereof;

FIG. 5 is a front elevation view thereof;

FIG. 6 is a left side elevation view thereof; and,

FIG. 7 is a right side elevation view thereof.

The broken line portion of the figure drawings is included to show unclaimed subject matter only and forms no part of the claimed design.

1 Claim, 4 Drawing Sheets

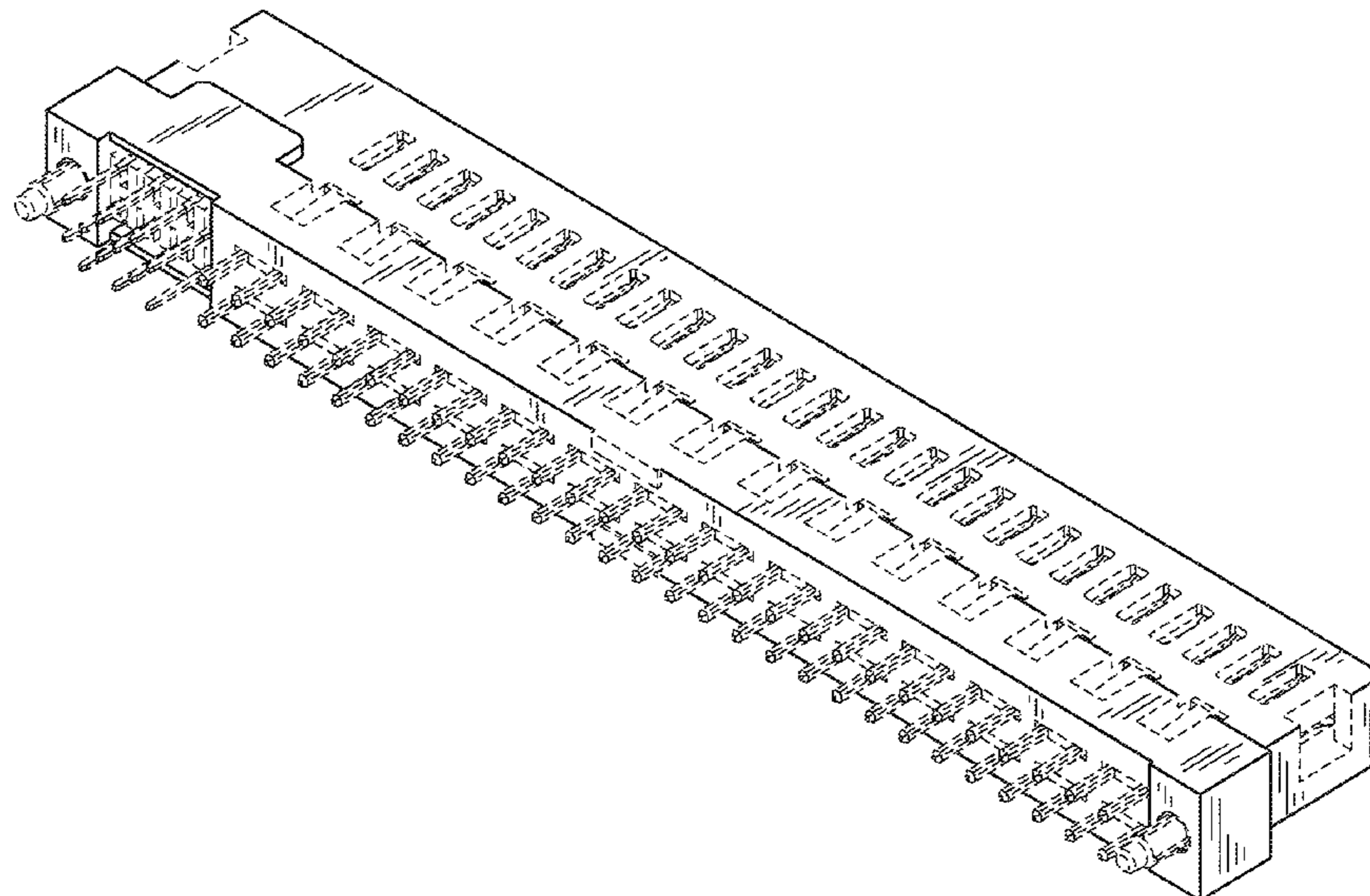

US D608,293 S

Page 2

U.S. PATENT DOCUMENTS						
			5,590,463	A	1/1997	Feldman et al.
			5,609,502	A	3/1997	Thumma
			5,618,187	A	4/1997	Goto
			5,637,008	A	6/1997	Kozel
			5,643,009	A	7/1997	Dinkel et al.
			5,664,973	A	9/1997	Emmert et al.
			5,691,041	A	11/1997	Frankeny et al.
			5,702,255	A	12/1997	Murphy et al.
			5,727,963	A	3/1998	LeMaster
			5,730,609	A	3/1998	Harwath
			5,741,144	A	4/1998	Elco et al.
			5,741,161	A	4/1998	Cahaly et al.
			5,742,484	A	4/1998	Gillette et al.
			5,743,009	A	4/1998	Matsui et al.
			5,745,349	A	4/1998	Lemke
			5,746,608	A	5/1998	Taylor
			5,755,595	A	5/1998	Davis et al.
			5,772,451	A	6/1998	Dozier, II et al.
			5,787,971	A	8/1998	Dodson
			5,795,191	A	8/1998	Preputnick et al.
			5,810,607	A	9/1998	Shih et al.
			5,817,973	A	10/1998	Elco et al.
			5,831,314	A	11/1998	Wen
			5,857,857	A	1/1999	Fukuda
			5,874,776	A	2/1999	Kresge et al.
			5,876,219	A	3/1999	Taylor et al.
			5,876,248	A	3/1999	Brunker et al.
			5,883,782	A	3/1999	Thurston et al.
			5,888,884	A	3/1999	Wojnarowski
			5,908,333	A	6/1999	Perino et al.
			5,919,050	A	7/1999	Kehley et al.
			5,930,114	A	7/1999	Kuzmin et al.
			5,955,888	A	9/1999	Frederickson et al.
			5,961,355	A	10/1999	Morlion et al.
			5,971,817	A	10/1999	Longueville
			5,975,921	A	11/1999	Shuey
			5,980,270	A	11/1999	Fjelstad et al.
			5,980,321	A	11/1999	Cohen et al.
			5,984,726	A	11/1999	Wu
			5,993,259	A	11/1999	Stokoe et al.
			6,012,948	A	1/2000	Wu
			6,036,549	A	3/2000	Wulff
			6,050,862	A	4/2000	Ishii
			6,059,170	A	5/2000	Jimarez et al.
			6,065,951	A	5/2000	Lemke et al.
			6,068,520	A	5/2000	Winings et al.
			6,071,152	A	6/2000	Achammer et al.
			6,077,130	A	6/2000	Hughes et al.
			6,089,878	A	7/2000	Meng
			6,095,827	A	8/2000	Dutkowsky et al.
			6,102,754	A	8/2000	Capper et al.
			6,123,554	A	9/2000	Ortega et al.
			6,125,535	A	10/2000	Chiou et al.
			6,139,336	A	10/2000	Olson
			6,146,157	A	11/2000	Lenoir et al.
			6,146,202	A	11/2000	Ramey et al.
			6,146,203	A	11/2000	Elco et al.
			6,152,756	A	11/2000	Huang et al.
			6,174,198	B1	1/2001	Wu et al.
			6,180,891	B1	1/2001	Murdeshwar
			6,183,287	B1	2/2001	Po
			6,183,301	B1	2/2001	Paagman
			6,190,213	B1	2/2001	Reichart et al.
			6,196,871	B1	3/2001	Szu
			6,202,916	B1	3/2001	Updike et al.
			6,210,197	B1	4/2001	Yu
			6,210,240	B1	4/2001	Comerci et al.
			6,212,755	B1	4/2001	Shimada et al.
			6,215,180	B1	4/2001	Chen et al.
			6,219,913	B1	4/2001	Uchiyama
			6,220,884	B1	4/2001	Lin
			6,220,895	B1	4/2001	Lin
			6,220,896	B1	4/2001	Bertoncini et al.
3,942,856	A	3/1976	Mindheim et al.			
3,972,580	A	8/1976	Pemberton et al.			
4,070,088	A	1/1978	Vaden			
4,076,362	A	2/1978	Ichimura			
4,136,919	A	1/1979	Howard et al.			
4,159,861	A	7/1979	Anhalt			
4,217,024	A	8/1980	Aldridge et al.			
4,260,212	A	4/1981	Ritchie et al.			
4,288,139	A	9/1981	Cobaugh et al.			
4,371,912	A	2/1983	Guzik			
4,383,724	A	5/1983	Verhoeven			
4,402,563	A	9/1983	Sinclair			
4,403,821	A	9/1983	Zimmerman et al.			
4,505,529	A	3/1985	Barkus			
4,531,793	A	7/1985	Hochgesang			
4,533,187	A	8/1985	Kirkman			
4,536,955	A	8/1985	Gudgeon			
4,545,610	A	10/1985	Lakritz et al.			
4,552,425	A	11/1985	Billman			
4,560,222	A	12/1985	Dambach			
4,564,259	A	1/1986	Vandame			
4,596,433	A	6/1986	Oesterheld et al.			
4,685,886	A	8/1987	Denlinger et al.			
4,717,360	A	1/1988	Czaja			
4,734,041	A	3/1988	Bruchmann et al.			
4,767,344	A	8/1988	Noschese			
4,776,803	A	10/1988	Pretchel et al.			
4,815,987	A	3/1989	Kawano et al.			
4,820,182	A	4/1989	Harwath et al.			
4,867,713	A	9/1989	Ozu et al.			
4,878,611	A	11/1989	LoVasco et al.			
4,881,905	A	11/1989	Demler, Jr. et al.			
4,900,271	A	2/1990	Colleran et al.			
4,907,990	A	3/1990	Bertho et al.			
4,915,641	A	4/1990	Miskin et al.			
4,963,102	A	10/1990	Gettig et al.			
4,973,257	A	11/1990	Lhotak			
4,973,271	A	11/1990	Ishizuka et al.			
5,016,968	A	5/1991	Hammond et al.			
5,024,610	A	6/1991	French et al.			
5,035,639	A	7/1991	Kilpatrick et al.			
5,052,953	A	10/1991	Weber			
5,066,236	A	11/1991	Broeksteeg			
5,077,893	A	1/1992	Mosquera et al.			
5,082,459	A	1/1992	Billman et al.			
5,094,634	A	3/1992	Dixon et al.			
5,104,332	A	4/1992	McCoy			
5,147,228	A	9/1992	Miller et al.			
5,151,056	A	9/1992	McClune			
5,174,770	A	12/1992	Sasaki et al.			
5,214,308	A	5/1993	Nishiguchi			
5,238,414	A	8/1993	Yaegashi et al.			
5,254,012	A	10/1993	Wang			
5,274,918	A	1/1994	Reed			
5,276,964	A	1/1994	Anderson, Jr. et al.			
5,277,597	A	1/1994	Masami et al.			
5,295,843	A	3/1994	Davis et al.			
5,302,135	A	4/1994	Lee			
5,381,314	A	1/1995	Rudy, Jr. et al.			
5,400,949	A	3/1995	Hirvonen et al.			
5,427,543	A	6/1995	Dynia			
5,431,578	A	7/1995	Wayne			
5,457,342	A	10/1995	Herbst, II			
5,475,922	A	12/1995	Tamura et al.			
5,490,040	A	2/1996	Gavdenzi et al.			
5,511,987	A	4/1996	Shinchi			
5,533,915	A	7/1996	Deans			
5,558,542	A	9/1996	O'Sullivan et al.			
5,577,928	A	11/1996	Duclos			
5,582,519	A	12/1996	Buchter			
5,588,859	A	12/1996	Maurice			

US D608,293 S

Page 3

6,234,851 B1	5/2001	Phillips	6,829,143 B2	12/2004	Russell et al.
6,238,225 B1	5/2001	Middlehurst et al.	6,835,103 B2	12/2004	Middlehurst et al.
6,254,435 B1	7/2001	Cheong et al.	6,840,783 B2	1/2005	Wolford et al.
6,257,478 B1	7/2001	Straub	6,843,687 B2	1/2005	McGowan et al.
6,259,039 B1	7/2001	Chroneos, Jr. et al.	6,848,886 B2	2/2005	Schmaling et al.
6,269,539 B1	8/2001	Takahashi et al.	6,848,950 B2	2/2005	Allison et al.
6,274,474 B1	8/2001	Caletka et al.	6,848,953 B2	2/2005	Schell et al.
6,280,216 B1	8/2001	Bernier et al.	6,869,294 B2	3/2005	Clark et al.
6,293,827 B1	9/2001	Stokoe et al.	6,884,117 B2	4/2005	Korsunsky et al.
6,299,492 B1	10/2001	Pierini et al.	6,890,221 B2	5/2005	Wagner
6,309,245 B1	10/2001	Sweeney	6,905,367 B2	6/2005	Crane, Jr. et al.
6,319,075 B1	11/2001	Clark et al.	6,923,661 B1	8/2005	Bogiel et al.
6,322,377 B2	11/2001	Middlehurst et al.	6,929,504 B2	8/2005	Ling et al.
6,328,602 B1	12/2001	Yamasaki et al.	6,947,012 B2	9/2005	Aisenbrey
6,347,952 B1	2/2002	Hasegawa et al.	6,975,511 B1	12/2005	Lebo et al.
6,350,134 B1	2/2002	Fogg et al.	6,994,569 B2	2/2006	Minich et al.
6,359,783 B1	3/2002	Noble	7,001,189 B1	2/2006	McGowan et al.
6,360,940 B1	3/2002	Bolde et al.	D518,786 S *	4/2006	Riku D13/147
6,362,961 B1	3/2002	Chiou	7,059,892 B1	6/2006	Trout
6,363,607 B1	4/2002	Chen et al.	7,059,919 B2	6/2006	Clark et al.
6,371,773 B1	4/2002	Crofoot et al.	7,065,871 B2	6/2006	Minich et al.
6,379,188 B1	4/2002	Cohen et al.	7,070,464 B2	7/2006	Clark et al.
6,386,924 B2	5/2002	Long	7,074,096 B2	7/2006	Copper et al.
6,394,818 B1	5/2002	Smalley, Jr.	7,101,228 B2	9/2006	Hammer et al.
6,402,566 B1	6/2002	Middlehurst et al.	7,104,812 B1	9/2006	Bogiel et al.
6,409,543 B1	6/2002	Astbury, Jr. et al.	7,114,963 B2	10/2006	Shuey et al.
6,428,328 B2	8/2002	Haba et al.	RE39,380 E	11/2006	Davis
6,431,914 B1	8/2002	Billman	7,137,848 B1	11/2006	Trout et al.
6,435,914 B1	8/2002	Billman	7,168,963 B2	1/2007	Minich et al.
6,450,289 B1	9/2002	Field et al.	7,182,642 B2	2/2007	Ngo et al.
6,461,202 B2	10/2002	Kline	7,204,699 B2	4/2007	Stoner
6,471,523 B1	10/2002	Shuey	D542,736 S *	5/2007	Riku D13/147
6,471,548 B2	10/2002	Bertoncini et al.	7,220,141 B2	5/2007	Daily et al.
6,488,549 B1	12/2002	Weller et al.	D545,275 S *	6/2007	Wei et al. D13/147
6,489,567 B2	12/2002	Zachrai	7,258,562 B2	8/2007	Daily et al.
6,506,081 B2	1/2003	Blanchfield et al.	7,273,382 B2	9/2007	Igarashi et al.
6,514,103 B2	2/2003	Pape et al.	7,303,427 B2	12/2007	Swain
6,537,111 B2	3/2003	Brammer et al.	7,335,043 B2	2/2008	Ngo et al.
6,544,046 B1	4/2003	Hahn et al.	7,347,740 B2	3/2008	Minich
6,551,112 B1	4/2003	Li et al.	7,354,282 B2	4/2008	Margulis et al.
6,554,647 B1	4/2003	Cohen et al.	7,374,436 B2	5/2008	Schell et al.
6,572,410 B1	6/2003	Volstorf et al.	7,402,064 B2	7/2008	Daily et al.
6,575,774 B2	6/2003	Ling et al.	2001/0003685 A1	6/2001	Aritani
6,592,381 B2	7/2003	Cohen et al.	2002/0106930 A1	8/2002	Pape et al.
6,604,967 B2	8/2003	Middlehurst et al.	2002/0142676 A1	10/2002	Hosaka et al.
6,629,854 B2	10/2003	Murakami	2002/0159235 A1	10/2002	Miller et al.
6,645,012 B2	11/2003	Ito et al.	2002/0193019 A1	12/2002	Blanchfield et al.
6,652,294 B1 *	11/2003	Zhang 439/83	2003/0013330 A1	1/2003	Takeuchi
6,652,318 B1	11/2003	Winings et al.	2003/0143894 A1	7/2003	Kline et al.
6,652,322 B2	11/2003	Ito et al.	2003/0219999 A1	11/2003	Minich et al.
6,663,426 B2	12/2003	Hasircoglu et al.	2003/0220021 A1	11/2003	Whiteman, Jr. et al.
6,665,189 B1	12/2003	Lebo	2003/0236035 A1	12/2003	Kuroda et al.
6,669,514 B2	12/2003	Wiebking et al.	2004/0183094 A1	9/2004	Caletka et al.
6,672,884 B1	1/2004	Toh et al.	2005/0112952 A1	5/2005	Wang et al.
6,672,907 B2	1/2004	Azuma	2006/0003620 A1	1/2006	Daily et al.
6,692,272 B2	2/2004	Lemke et al.	2006/0128197 A1	6/2006	McGowan et al.
6,702,594 B2	3/2004	Lee et al.	2006/0228927 A1	10/2006	Daily
6,705,902 B1	3/2004	Yi et al.	2006/0228948 A1	10/2006	Swain
6,712,621 B2	3/2004	Li et al.	2006/0281354 A1	12/2006	Ngo et al.
6,716,068 B2	4/2004	Wu	2007/0197063 A1	8/2007	Ngo
6,740,820 B2	5/2004	Cheng	2007/0202748 A1	8/2007	Daily
6,743,037 B2	6/2004	Kassa et al.	2007/0275586 A1	11/2007	Ngo
6,746,278 B2	6/2004	Nelson et al.	2007/0293084 A1	12/2007	Ngo
6,769,883 B2	8/2004	Brid et al.	2008/0038956 A1	2/2008	Swain
6,769,935 B2	8/2004	Stokoe et al.	2008/0207029 A1	8/2008	Defibaugh et al.
6,776,635 B2	8/2004	Blanchfield et al.	2009/0088028 A1	4/2009	Ngo et al.
6,776,649 B2	8/2004	Pape et al.			
6,780,027 B2	8/2004	Allison			
6,790,088 B2	9/2004	Ono et al.			
6,796,831 B1	9/2004	Yasufuku et al.			
6,811,440 B1	11/2004	Rothermel et al.			
6,814,590 B2	11/2004	Minich et al.			
D499,379 S *	12/2004	Zhu et al. D13/147			

FOREIGN PATENT DOCUMENTS			
DE	102 26 279	C1	11/2003
EP	0 273 683	A2	7/1988
EP	0 321 257	B1	4/1993
EP	0 623 248	B1	11/1995

US D608,293 S

Page 4

EP	0 789 422 A2	8/1997
EP	1091449 B1	9/2004
GB	1 162 705	8/1969
JP	06 068943	3/1994
JP	06-236788	8/1994
JP	07-114958	5/1995
JP	07 169523	7/1995
JP	0 812 5379	5/1996
JP	09 199215	7/1997
JP	2000-003743	1/2000
JP	2000-003744	1/2000
JP	2000-003745	1/2000
JP	2000-003746	1/2000
JP	2003217785	7/2003
TW	576555	8/1990
TW	546872	8/2003

WO	WO 97/43885	11/1997
WO	WO 97/44859	11/1997
WO	WO 98/15989	4/1998
WO	WO 01/29931 A1	4/2001
WO	WO 01/39332 A1	5/2001

OTHER PUBLICATIONS

Sherman, L.M., "Plastics that Conduct Heat", *Plastics Technology Online*, Jun. 2001, <http://www.plasticstechnology.com>, 4 pages.

Ogando, J., "And now-An Injection-Molded Heat Exchanger", *Sure, plastics are thermal insulators, but additive packages allow them to conduct heat instead*, *Global Design News*, Nov. 1, 2000, 4 pages.

Introduction to High Current Card Edge Connectors, *Tyco Electronics, Catalog 1773096*, Revised Jul. 2007, 19 pages.

* cited by examiner

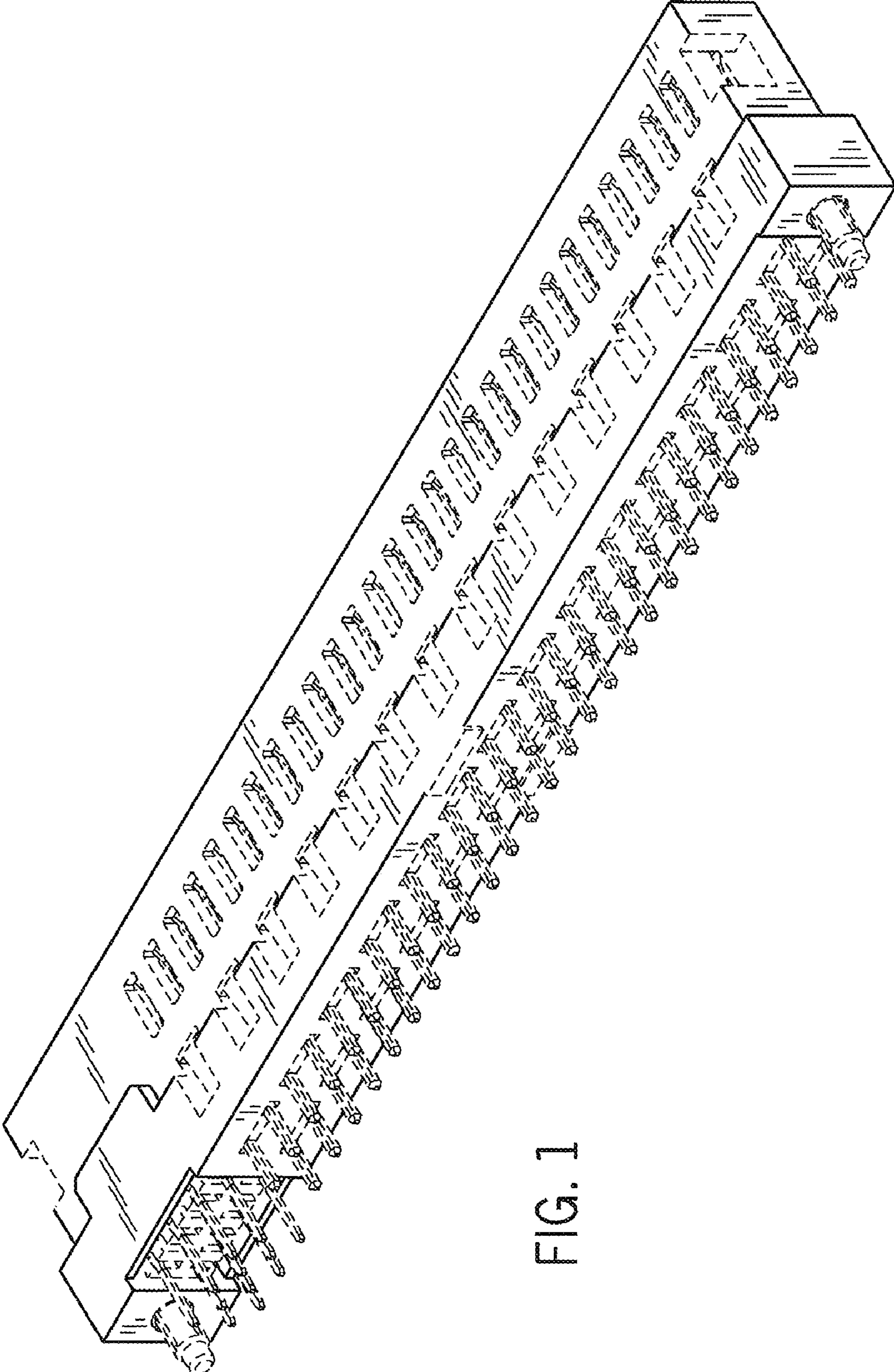

FIG. 1

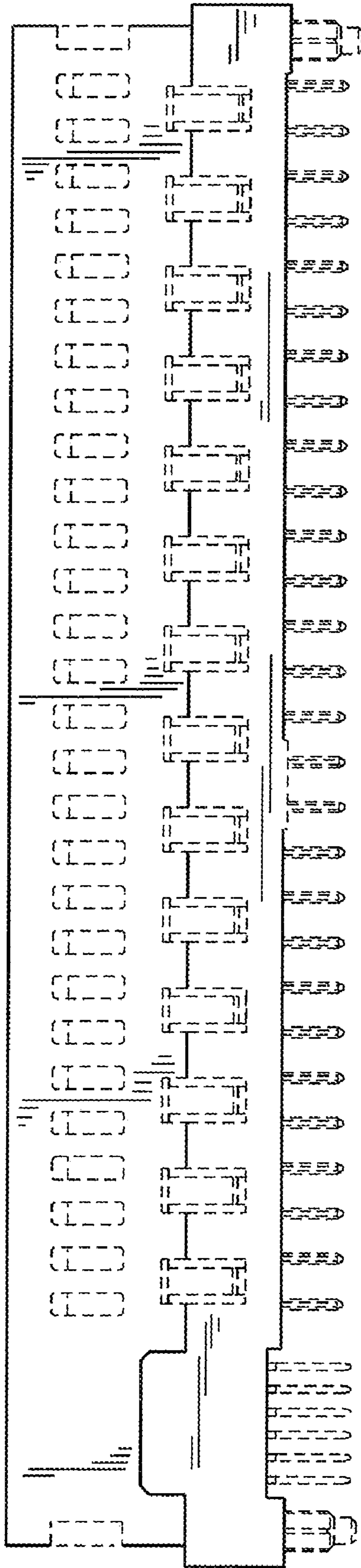

FIG. 2

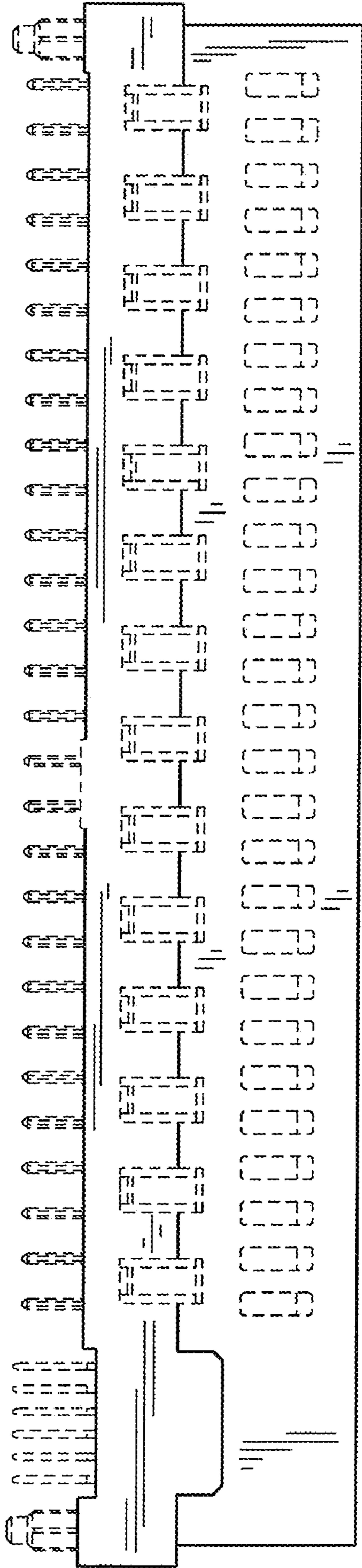

FIG. 3

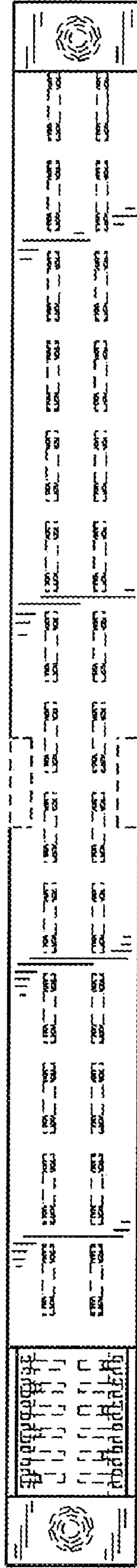

FIG. 4

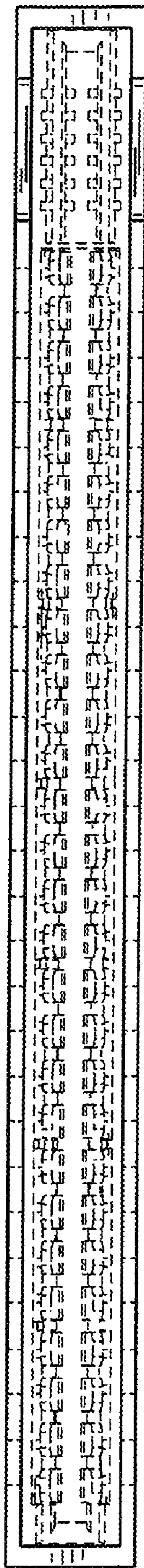

FIG. 5

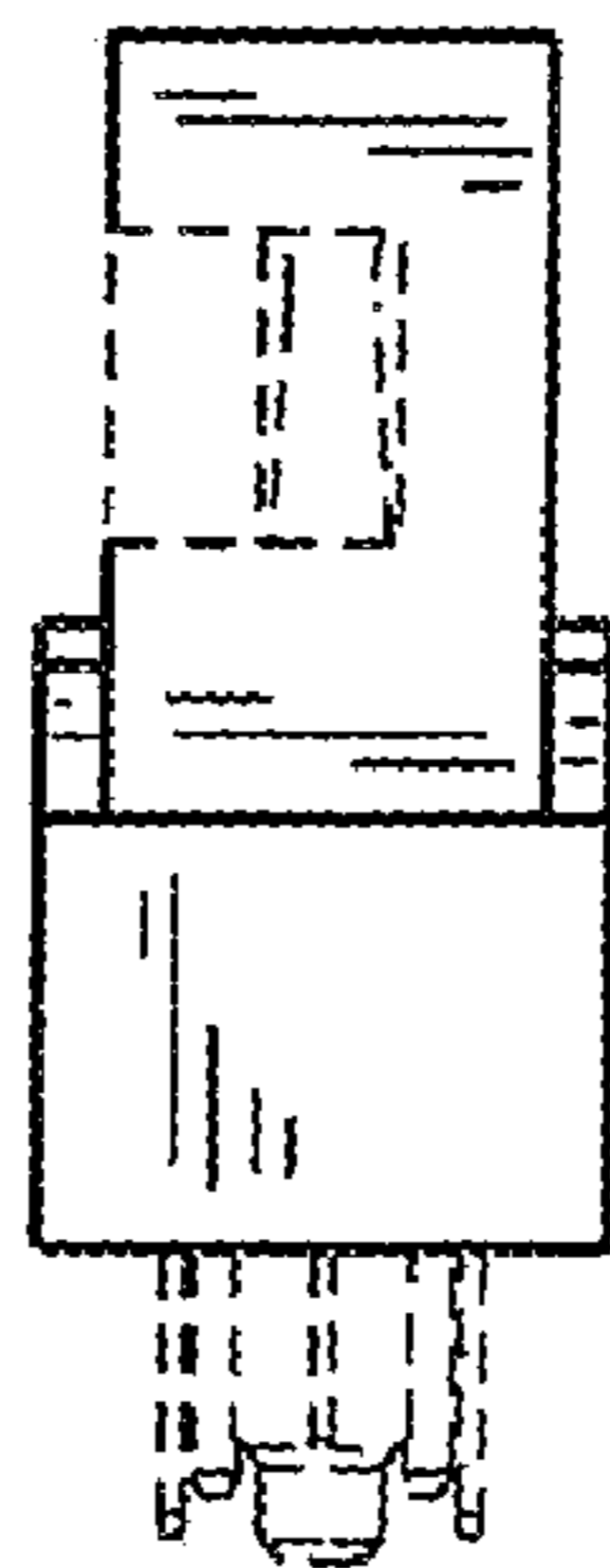

FIG. 6

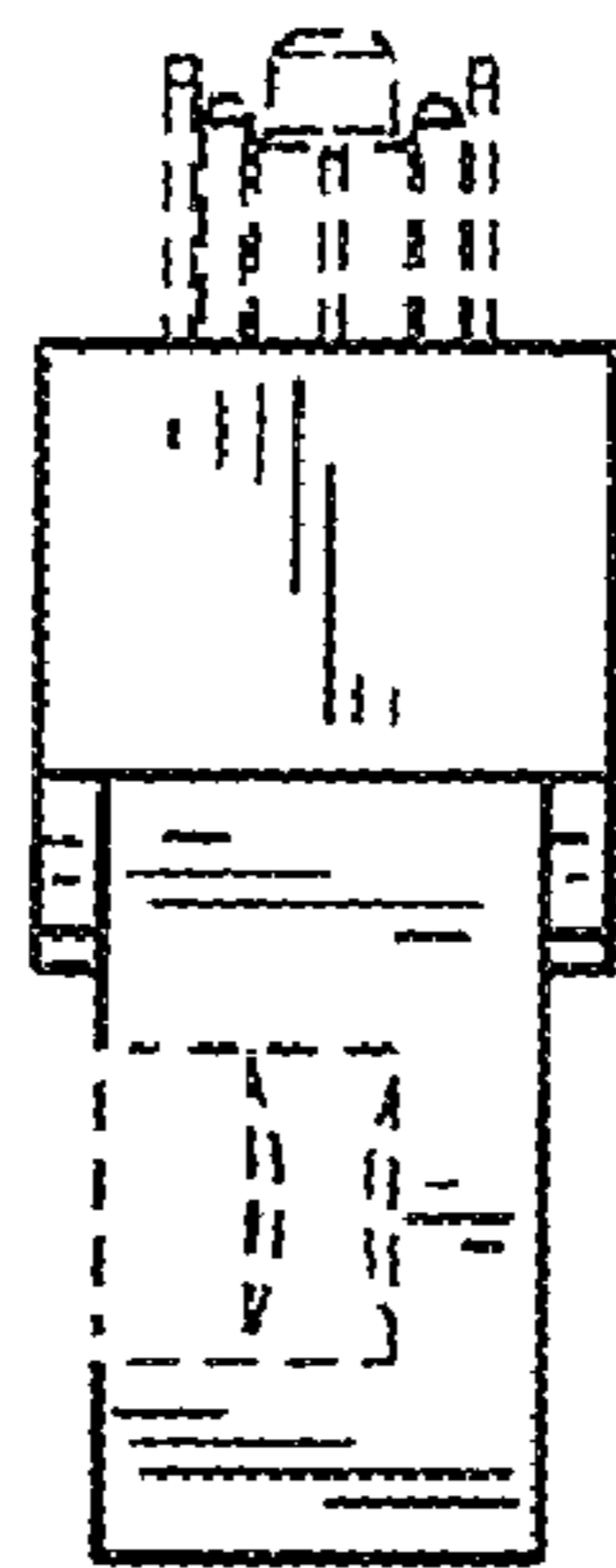

FIG. 7

UNITED STATES PATENT AND TRADEMARK OFFICE
CERTIFICATE OF CORRECTION

PATENT NO. : Des. 608,293 S
APPLICATION NO. : 29/331013
DATED : January 19, 2010
INVENTOR(S) : Hung Viet Ngo

Page 1 of 1

It is certified that error appears in the above-identified patent and that said Letters Patent is hereby corrected as shown below:

Title Page, before "DESCRIPTION" insert the following omitted paragraph:

-- CROSS-REFERENCE TO RELATED APPLICATIONS

This application is related by subject matter to U.S. Provisional Patent Application Serial No. 61/205,276 filed on January 16, 2009, and is further related by subject matter to U.S. Design Patent Application Serial Nos. 29/331,017 filed on January 16, 2009; 29/330,990 filed on January 16, 2009; and 29/330,997 filed on January 16, 2009. --

Signed and Sealed this

Thirteenth Day of April, 2010



David J. Kappos
Director of the United States Patent and Trademark Office