



US00D607912S

(12) **United States Design Patent**
Medici

(10) **Patent No.:** **US D607,912 S**
(45) **Date of Patent:** **** Jan. 12, 2010**

(54) **UNIVERSAL JOINT TRANSMISSION**
(75) Inventor: **Vittorio Medici**, Reggio Emilia (IT)
(73) Assignee: **A.M.A. Cardan S.r.l.**, Atessa (IT)
(**) Term: **14 Years**
(21) Appl. No.: **29/289,715**
(22) Filed: **Jul. 30, 2007**
(30) **Foreign Application Priority Data**
Jan. 29, 2007 (EM) 000660550
(51) **LOC (9) Cl.** **15-09**
(52) **U.S. Cl.** **D15/149**
(58) **Field of Classification Search** D15/143,
D15/148, 149; 403/59; 464/111, 114, 119,
464/130, 134, 145, 162, 179
See application file for complete search history.

(56) **References Cited**
U.S. PATENT DOCUMENTS
2002/0193167 A1* 12/2002 Kim 464/179
2003/0083133 A1* 5/2003 Sugiyama et al. 464/111
2003/0083136 A1* 5/2003 Park 464/162
2005/0282641 A1* 12/2005 Sadakata et al. 464/134
2006/0089202 A1* 4/2006 Losi, Jr. 464/114
2006/0128479 A1* 6/2006 Kapustin et al. 464/119

2006/0252557 A1* 11/2006 Schultze et al. 464/130
2007/0049382 A1* 3/2007 Ishijima et al. 464/145
2008/0108445 A1* 5/2008 Nagayama et al. 464/130
2009/0087250 A1* 4/2009 Une 403/59
* cited by examiner
Primary Examiner—Sandra Snapp
Assistant Examiner—Patricia Palasik
(74) *Attorney, Agent, or Firm*—Frommer Lawrence & Haug
LLP; Ronald R. Santucci

(57) **CLAIM**
The ornamental design for a universal joint transmission, as shown and described.

DESCRIPTION
FIG. 1 is a perspective view of a universal joint transmission;
FIG. 2 is a front view thereof;
FIG. 3 is a rear view thereof;
FIG. 4 is a first side view thereof;
FIG. 5 is a second side view thereof;
FIG. 6 is a third side view thereof; and,
FIG. 7 is a fourth side view thereof.
The broken lines in the drawings depict unclaimed environmental subject matter.

1 Claim, 7 Drawing Sheets

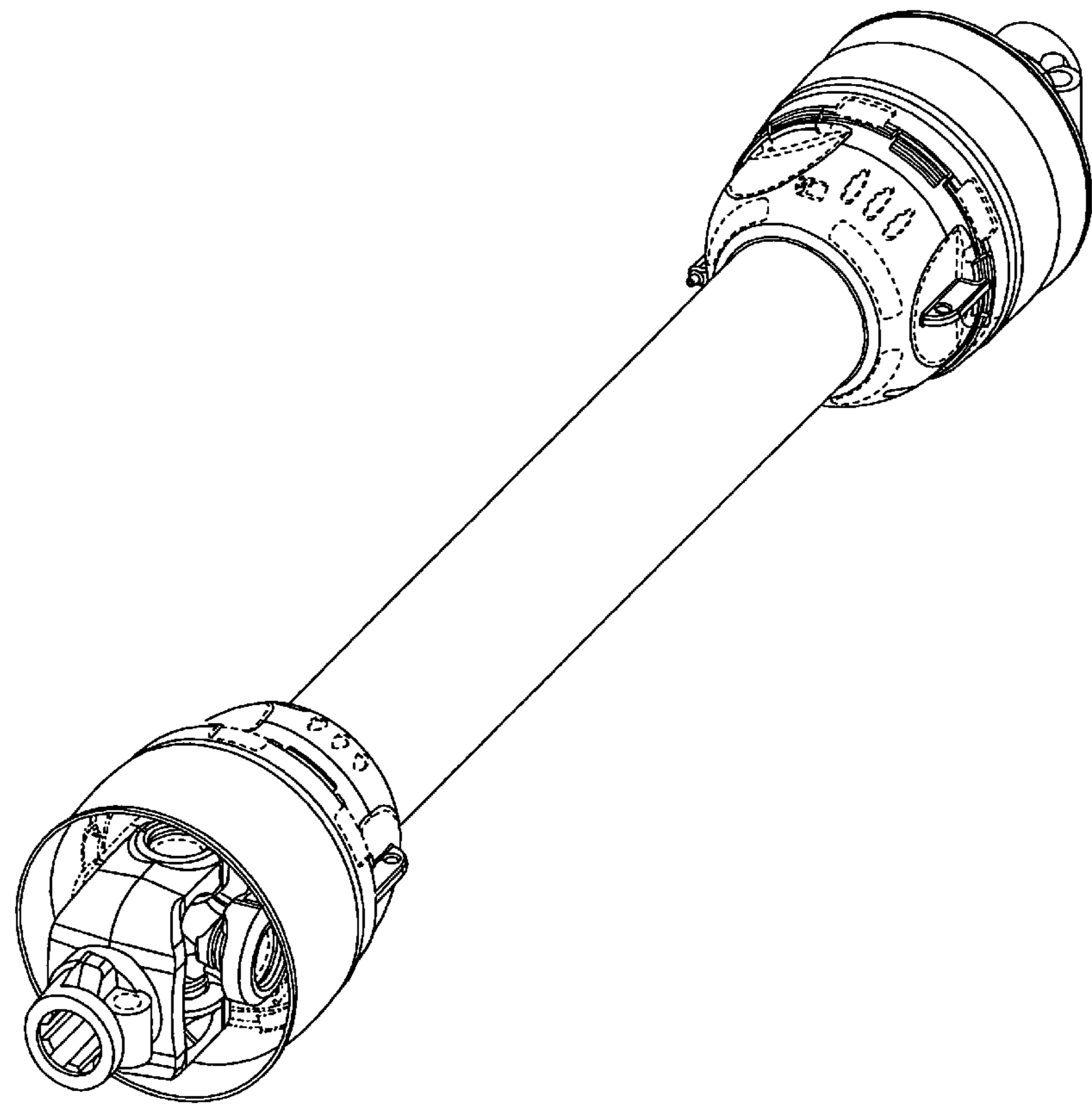

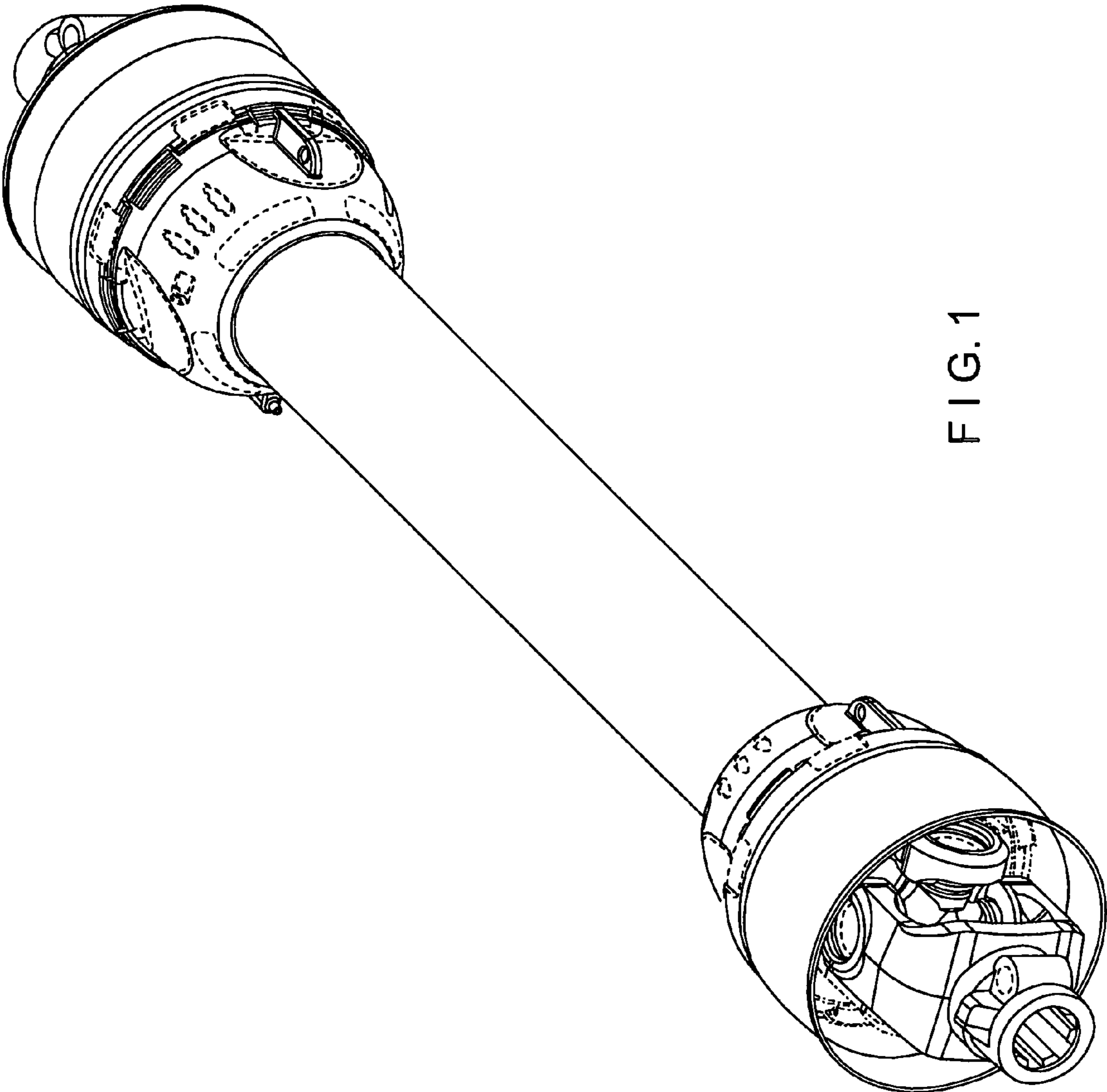

FIG. 1

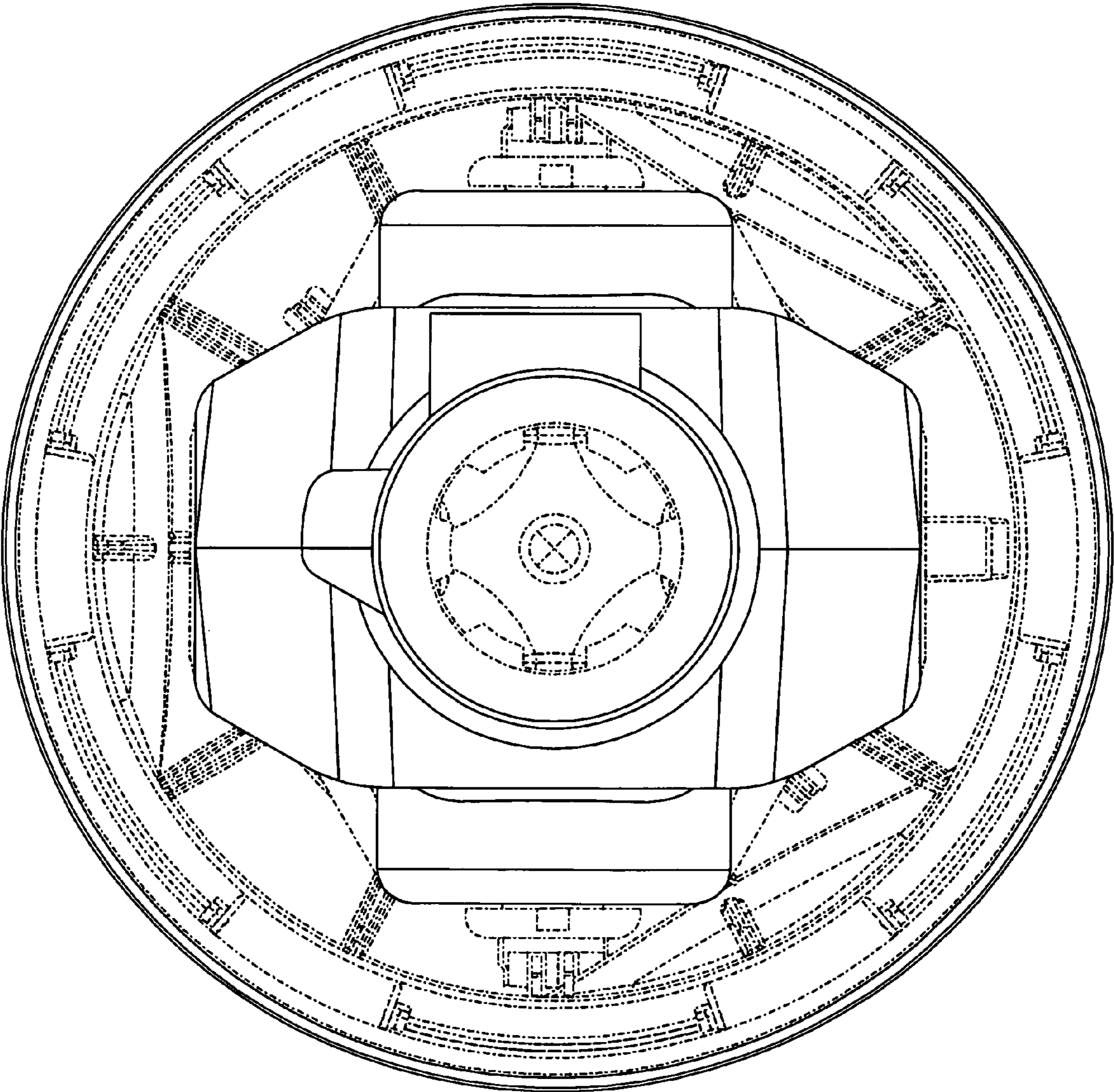

FIG. 2

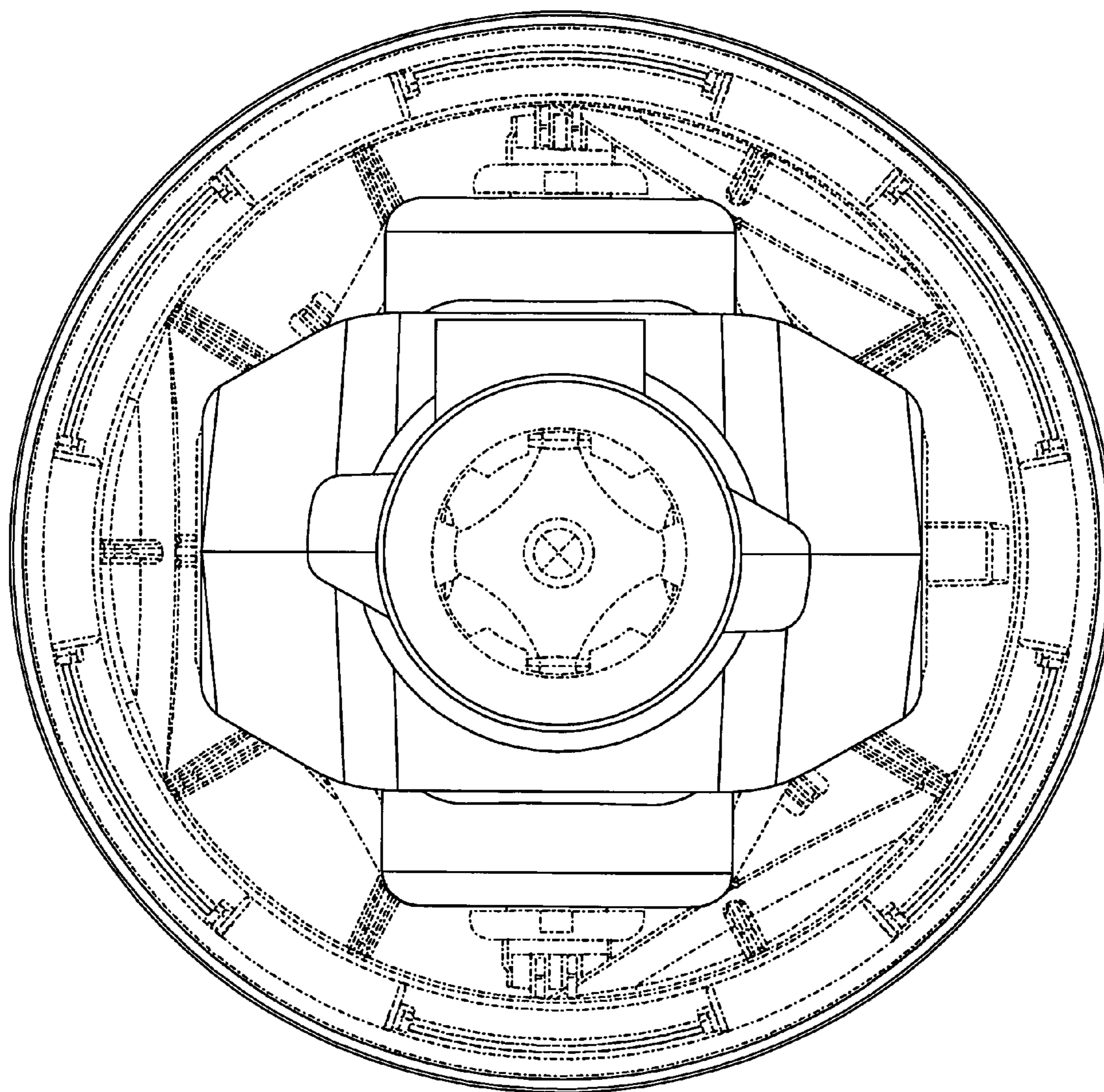

FIG. 3

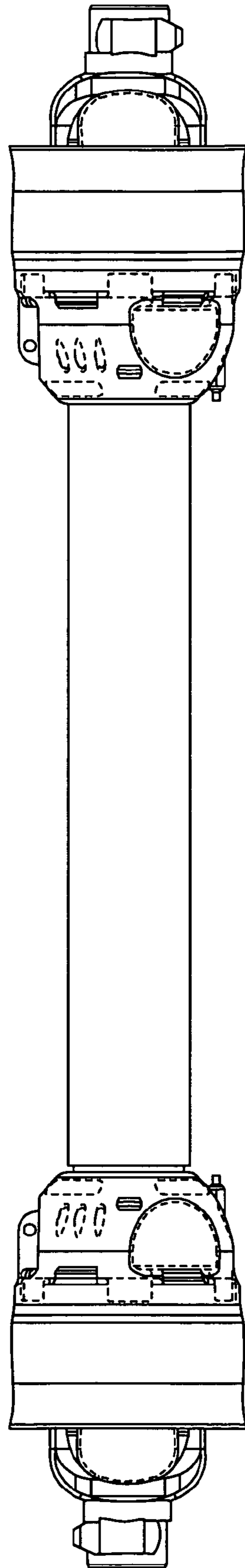

FIG. 4

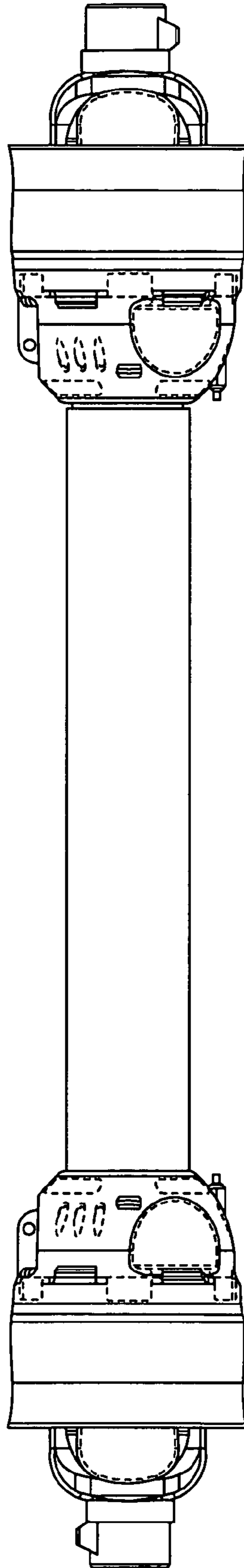

FIG. 5

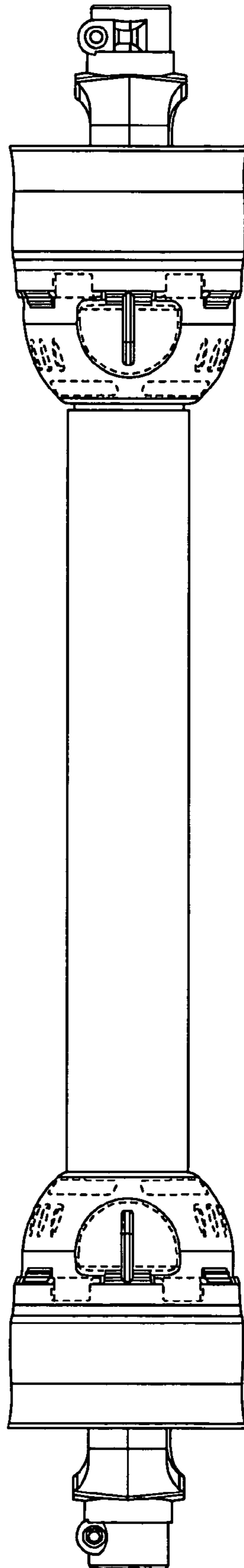

FIG. 6

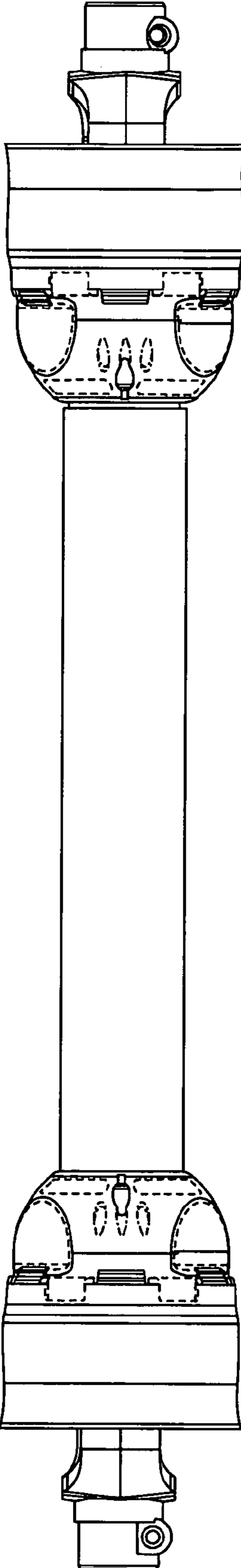

FIG. 7