



US00D607907S

(12) **United States Design Patent**  
**de Malherbe**

(10) **Patent No.:** **US D607,907 S**  
(45) **Date of Patent:** **\*\* Jan. 12, 2010**

(54) **REFRIGERATING UNIT**

D589,538 S \* 3/2009 Kumazawa et al. .... D15/81

(75) Inventor: **Hubert de Malherbe**, Paris (FR)

\* cited by examiner

(73) Assignee: **AHT Cooling Systems GmbH**,  
Rottenmann (AT)

*Primary Examiner*—Stella M Reid  
*Assistant Examiner*—Shanda C Hill  
(74) *Attorney, Agent, or Firm*—Fross Zelnick Lehrman &  
Zissu, P.C.; Charles T. J. Weigell, Esq.

(\*\*) Term: **14 Years**

(21) Appl. No.: **29/292,756**

(57) **CLAIM**

(22) Filed: **Oct. 25, 2007**

The ornamental design for a refrigerating unit, as shown and described.

(51) **LOC (9) Cl.** ..... **15-07**

(52) **U.S. Cl.** ..... **D15/83; D15/79**

(58) **Field of Classification Search** ..... D15/79,  
D15/81, 83, 84, 85; 62/3.6, 3.63, 3.64, 246–257;  
312/236, 400–408; D6/437, 470, 471, 473  
See application file for complete search history.

**DESCRIPTION**

FIG. 1 is a perspective view of a refrigerating unit showing the new design;

FIG. 2 is a front view of the refrigerating unit shown in FIG. 1;

FIG. 3 is a rear view of the refrigerating unit shown in FIG. 1;

FIG. 4 is a left side view of the refrigerating unit shown in FIG. 1;

FIG. 5 is a right side view of the refrigerating unit shown in FIG. 1; and,

FIG. 6 is a top view of the refrigerating unit shown in FIG. 1.

The broken line showing of the rear utility panel is for illustrative purposes only and forms no part of the claimed design.

(56) **References Cited**

**U.S. PATENT DOCUMENTS**

- D147,622 S \* 10/1947 Rideout ..... D6/470
- D209,722 S \* 12/1967 Mangini ..... D6/471
- D321,197 S \* 10/1991 Sekine et al. .... D15/83
- D400,545 S \* 11/1998 Iverlund ..... D15/81
- D427,210 S \* 6/2000 Tsukida ..... D15/83
- D439,913 S \* 4/2001 Jobst ..... D15/84
- D440,432 S \* 4/2001 Topper et al. .... D6/471
- D541,312 S \* 4/2007 Arato ..... D15/81

**1 Claim, 5 Drawing Sheets**

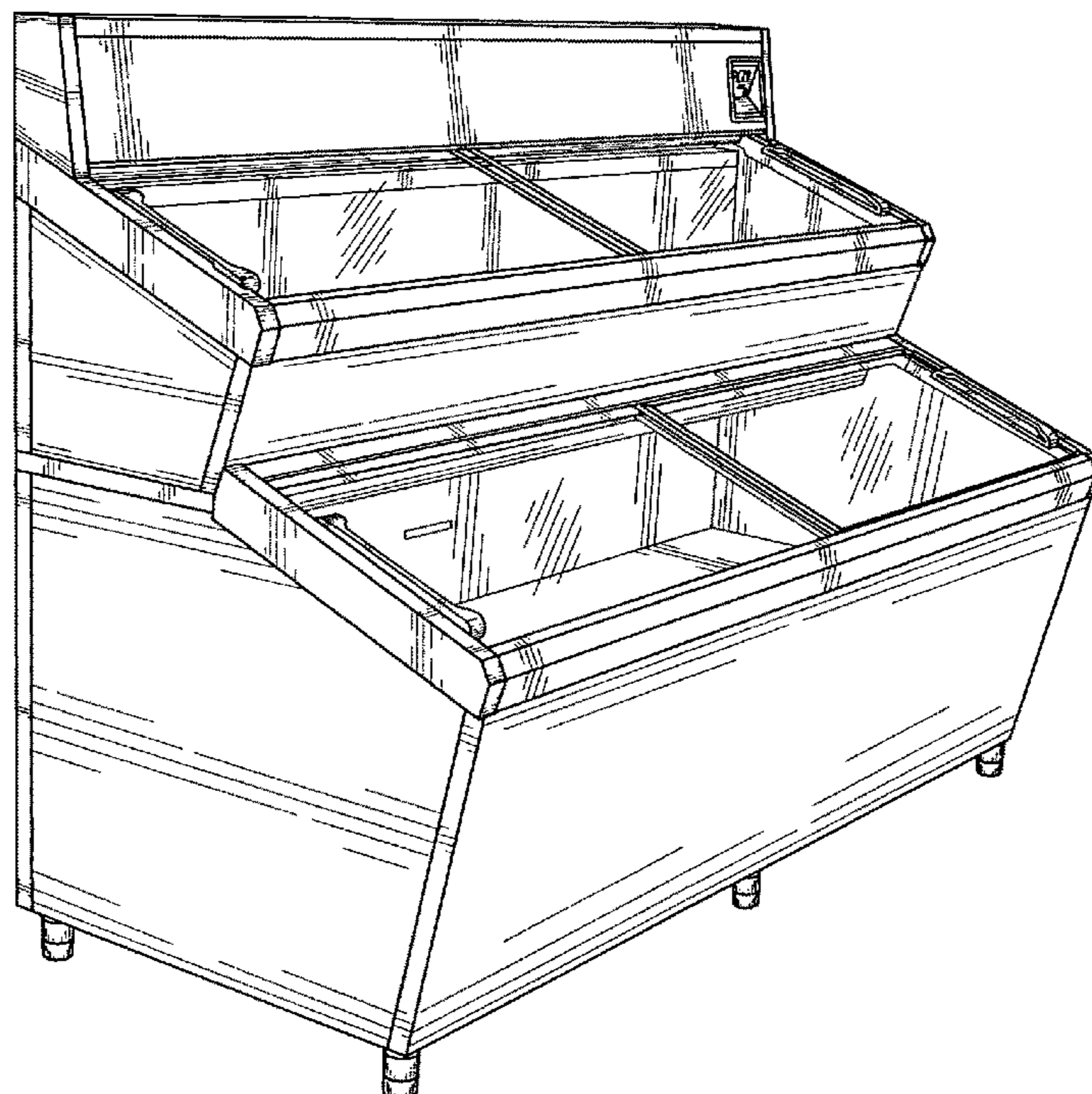

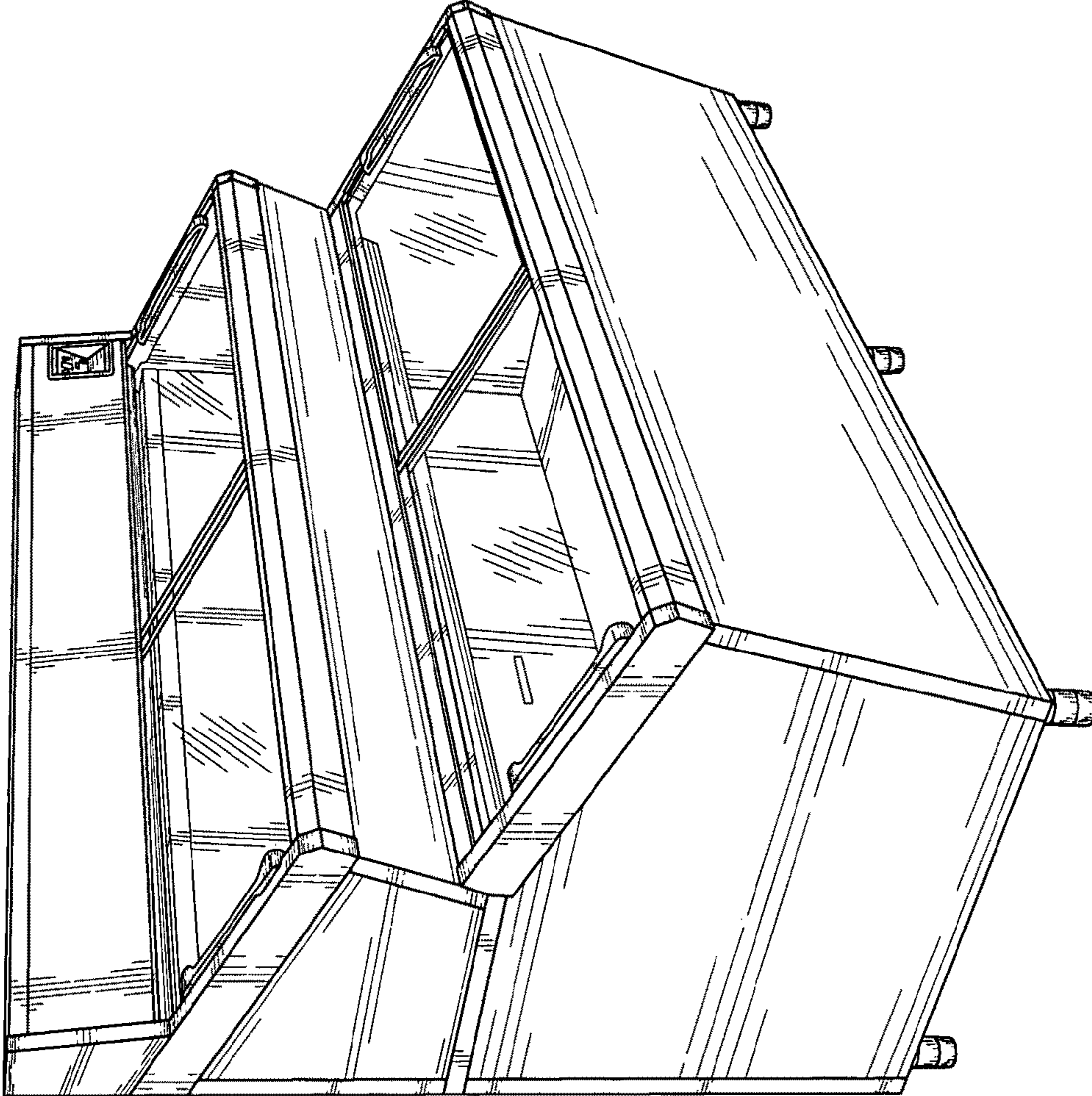

FIG. 1

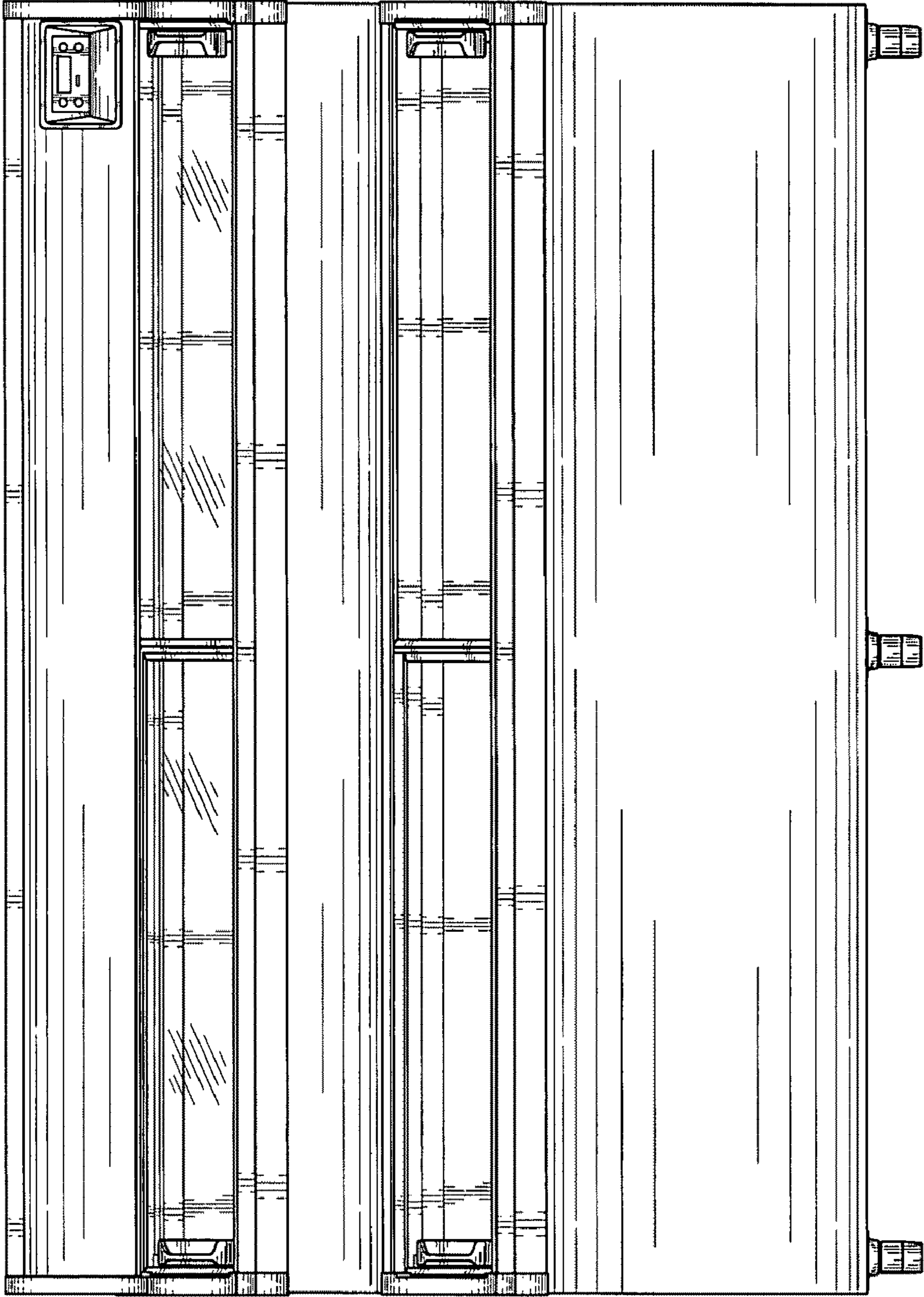

FIG. 2

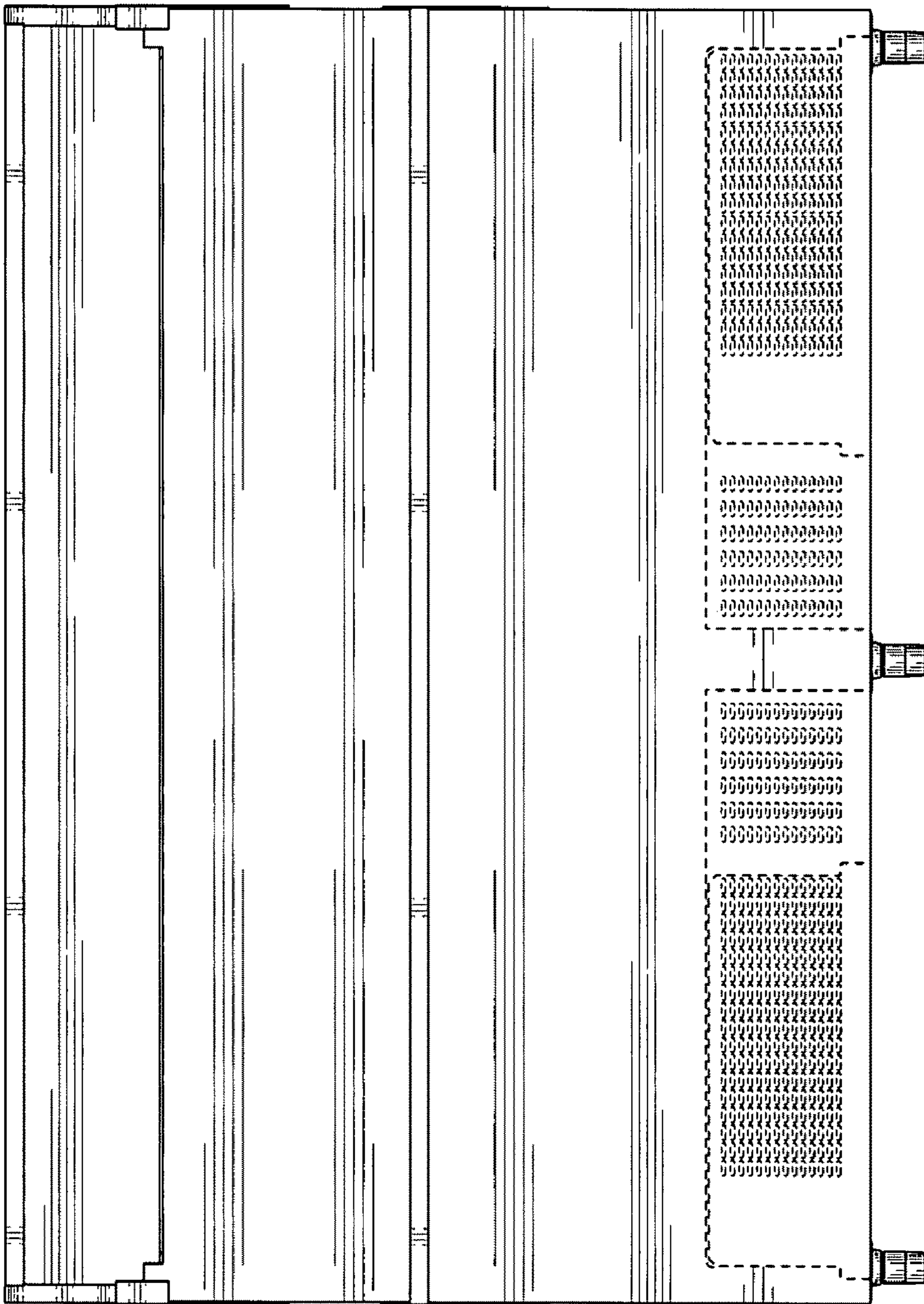

FIG. 3

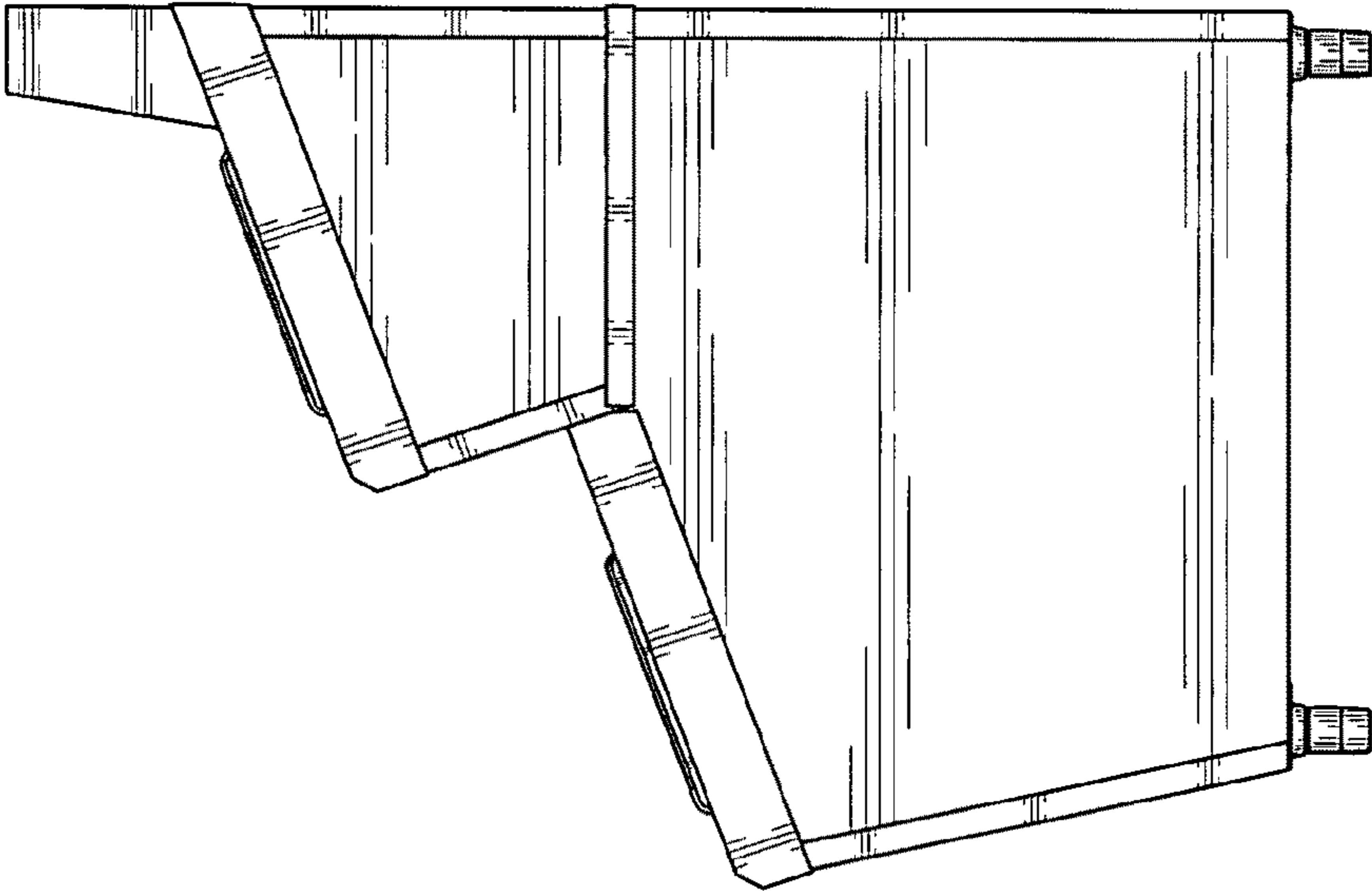

FIG. 5

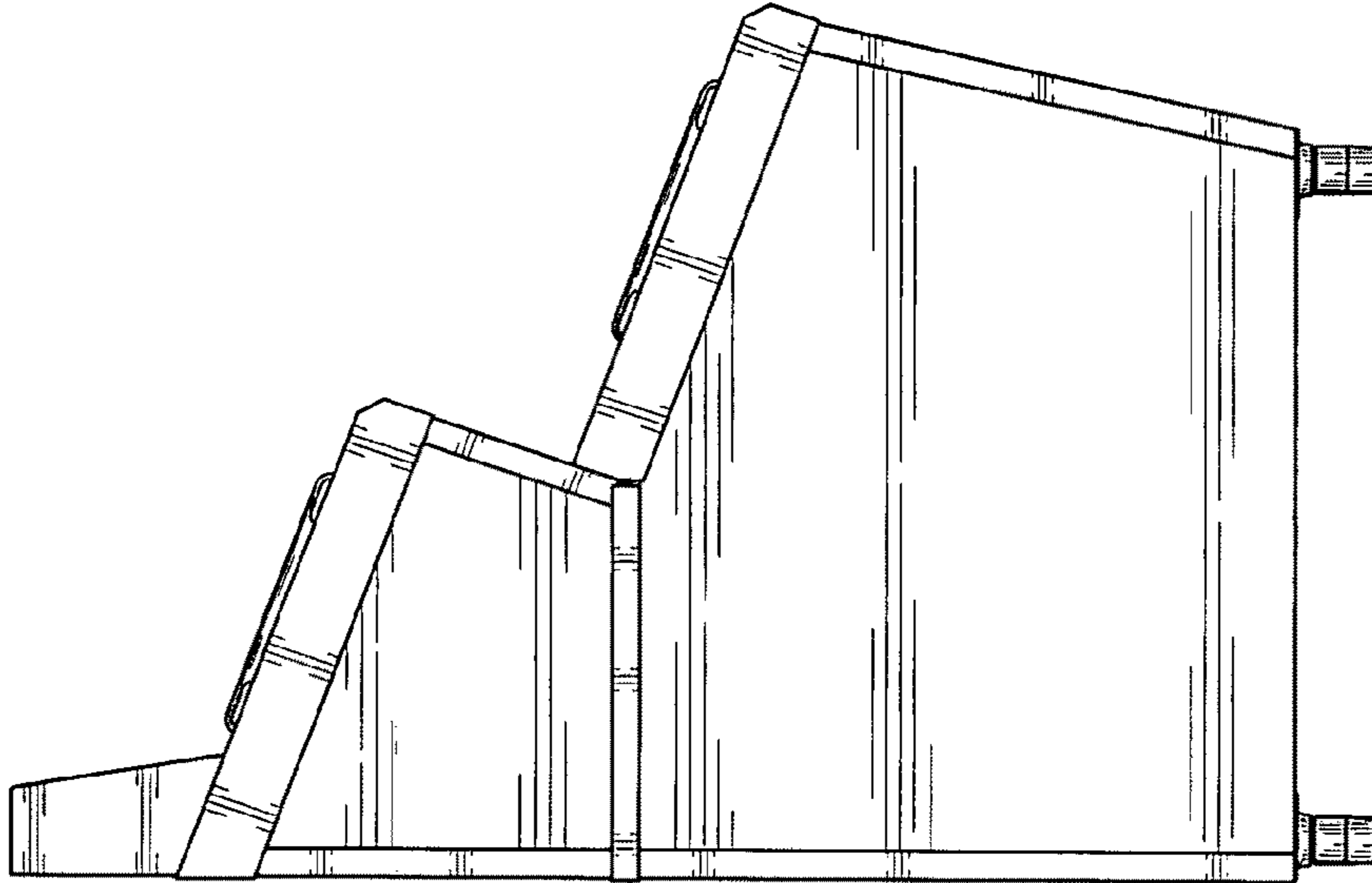

FIG. 4

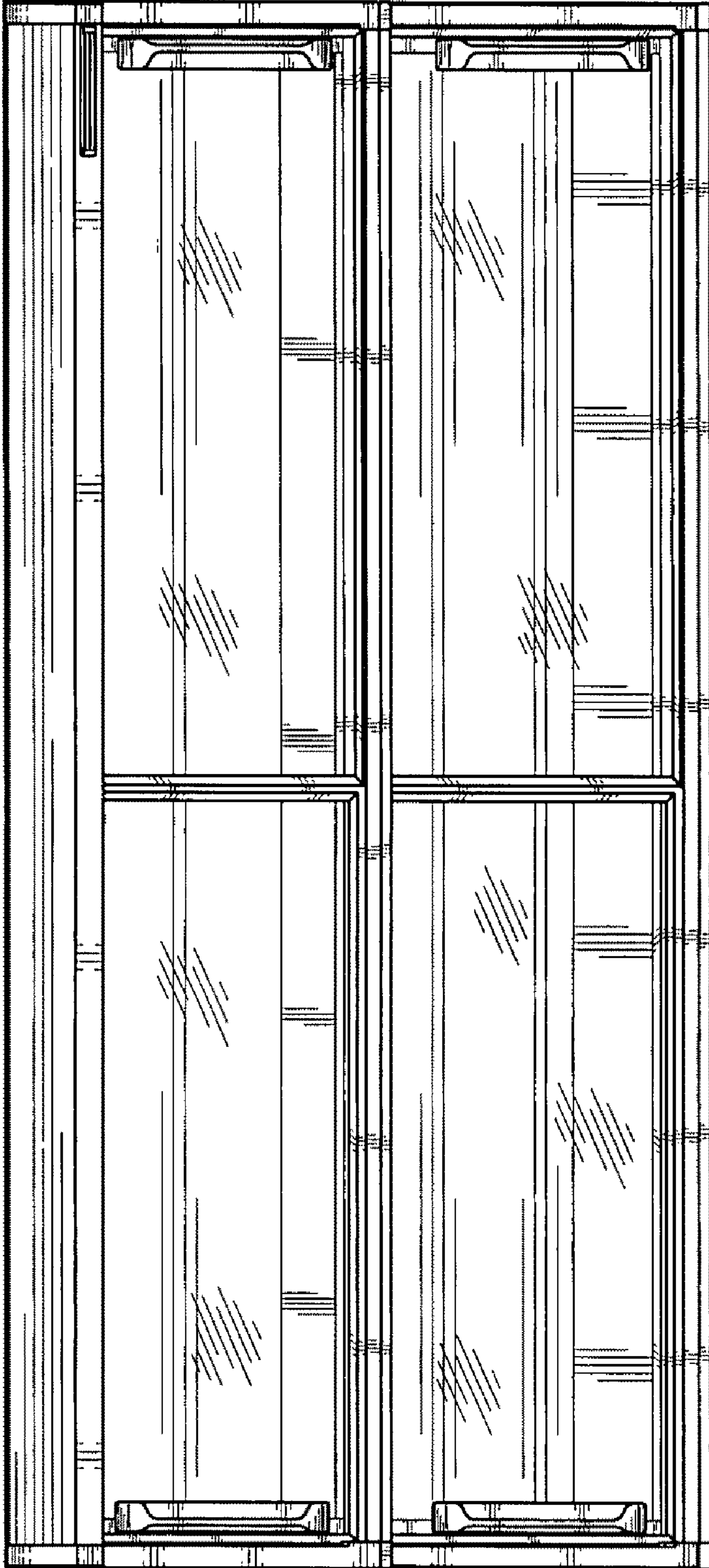

FIG. 6

UNITED STATES PATENT AND TRADEMARK OFFICE  
**CERTIFICATE OF CORRECTION**

PATENT NO. : Des. 607,907 S  
APPLICATION NO. : 29/292756  
DATED : January 12, 2010  
INVENTOR(S) : Hubert de Malherbe

Page 1 of 1

It is certified that error appears in the above-identified patent and that said Letters Patent is hereby corrected as shown below:

On the title page item (30): Foreign Application Priority Data should read:

(30) Foreign Application Priority Data

April 25, 2007 (EM) .....000714118-0002

Signed and Sealed this

Eighteenth Day of May, 2010



David J. Kappos  
*Director of the United States Patent and Trademark Office*