



US00D607885S

(12) **United States Design Patent**
Otani et al.

(10) **Patent No.:** **US D607,885 S**
(45) **Date of Patent:** **** Jan. 12, 2010**

(54) **PC CARD ADAPTER**

(75) Inventors: **Kazuyoshi R. Otani**, San Diego, CA (US); **Donald Shaffer**, San Diego, CA (US); **Kotaro Matsuo**, Poway, CA (US); **Peter On**, San Diego, CA (US); **Joseph Zueck**, Carlsbad, CA (US)

(73) Assignee: **Kyocera Corporation**, Kyoto (JP)

(**) Term: **14 Years**

(21) Appl. No.: **29/280,123**

(22) Filed: **May 17, 2007**

(51) **LOC (9) Cl.** **14-02**

(52) **U.S. Cl.** **D14/436**

(58) **Field of Classification Search** D14/242, D14/432-438; 361/600, 622, 683, 684, 686, 361/724-728, 801, 759, 740, 737, 752, 753, 361/799, 800, 807, 816, 818, 829, 736, 803, 361/823; D13/184, 123, 110; 379/433.09, 379/433.11-433.13, 419, 440, 428.01, 428.04; 455/550.1, 552.1, 553.1, 554.1, 554.2, 555, 455/557, 556.1, 558, 575.1, 90.3, 128, 276.1, 455/348, 351, 573; 439/101, 108, 946, 607, 439/352, 651, 928.1, 945, 76.1, 638, 630, 439/635, 135, 142, 951, 654, 639, 938.1, 439/676, 157, 131, 326, 91; 174/52.1, 35 R; 902/26; 273/148 B; 257/678-680; 343/700 MS, 343/702, 880; D3/273, 201

See application file for complete search history.

(56) **References Cited**

U.S. PATENT DOCUMENTS

D269,088 S * 5/1983 Genaro et al. D14/137
4,689,478 A * 8/1987 Hale et al. 235/380
4,858,070 A * 8/1989 Buron et al. 361/695
5,155,663 A 10/1992 Harase

5,339,222 A * 8/1994 Simmons et al. 361/818
D364,399 S * 11/1995 Long D14/433
D375,941 S * 11/1996 Kerklaan D13/182
5,657,028 A * 8/1997 Sanad 343/700 MS
5,660,568 A * 8/1997 Moshayedi 439/654
5,716,221 A * 2/1998 Kantner 439/64
5,752,857 A * 5/1998 Knights 439/638
5,757,622 A * 5/1998 Tanaka et al. 361/737

(Continued)

OTHER PUBLICATIONS

Internet Document: "Mittoni Secure Digital SD PCMCIA Adapter" Product Description, at <http://www.mittoni.com.au/secure-digital-sd-pcmcia-adapter-p-1182.html> (accessed Dec. 21, 2006).

Primary Examiner—Susan Moon Lee

(57) **CLAIM**

The ornamental design for a PC card adapter, as shown and described.

DESCRIPTION

FIG. 1 is a perspective view of a PC card adapter according to one embodiment.

FIG. 2 is a top view of the PC card adapter of FIG. 1.

FIG. 3 is a bottom view of the PC card adapter of FIG. 1.

FIG. 4 is a proximal end view of the PC card adapter of FIG. 1.

FIG. 5 is a distal end view of the PC card adapter of FIG. 1.

FIG. 6 is a right side view of the PC card adapter of FIG. 1; and,

FIG. 7 is a left side view of the PC card adapter of FIG. 1.

The rectangular space to the right of the logo label is a hollow window.

The broken lines are for purposes of illustration only and form no part of the claimed invention.

1 Claim, 3 Drawing Sheets

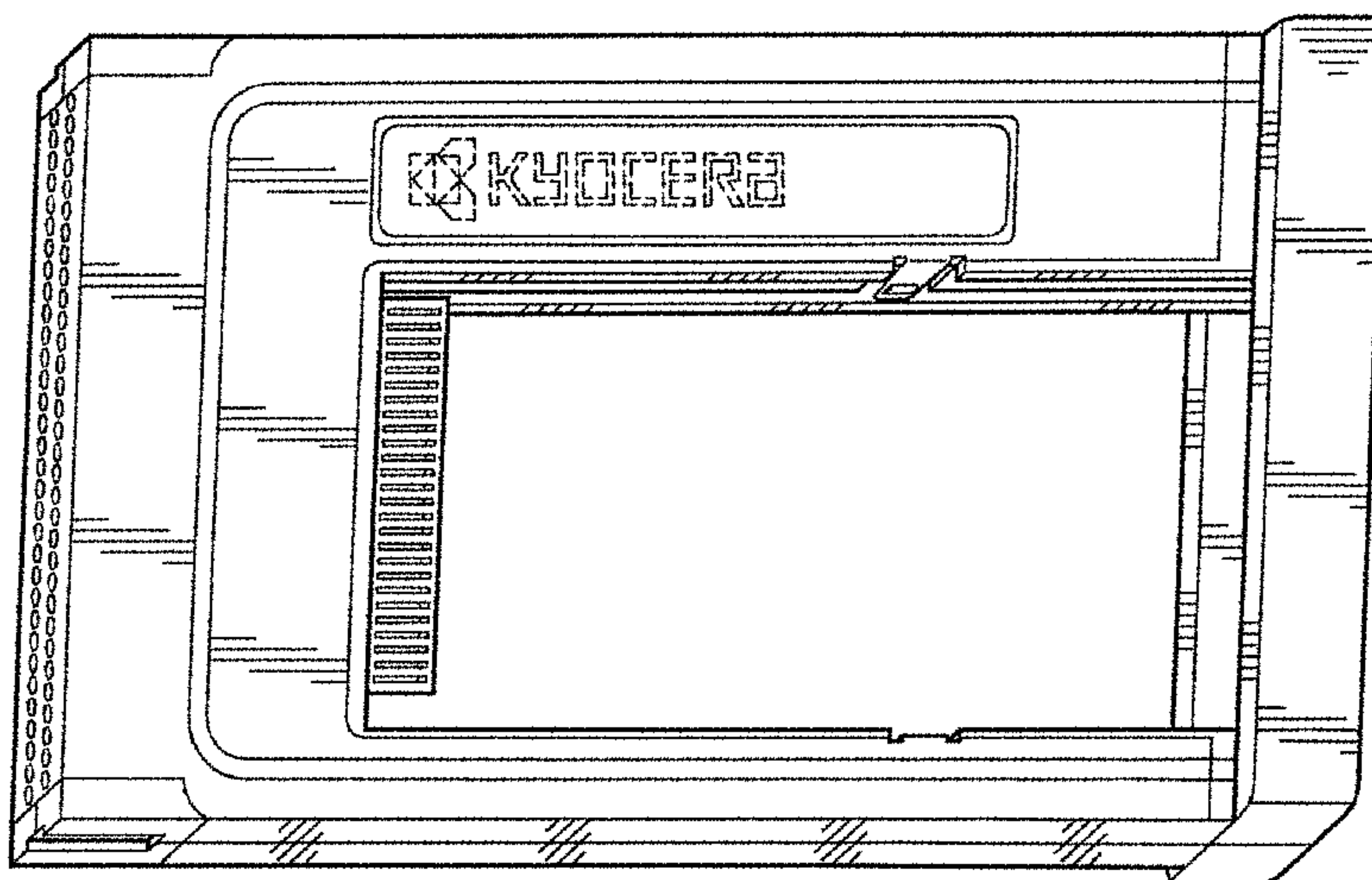

US D607,885 S

Page 2

U.S. PATENT DOCUMENTS

5,845,217	A *	12/1998	Lindell et al.	455/557	6,639,563	B1 *	10/2003	Gu	343/702
5,890,016	A *	3/1999	Tso	710/64	6,692,268	B2 *	2/2004	Kung et al.	439/76.1
5,918,163	A *	6/1999	Rossi	455/558	6,774,469	B2 *	8/2004	Utsumi	257/679
6,042,009	A	3/2000	Barrett et al.		6,780,062	B2 *	8/2004	Liu et al.	439/630
6,050,848	A *	4/2000	Yao	439/483	6,808,424	B2 *	10/2004	Kaneshiro et al.	439/638
6,097,605	A *	8/2000	Klatt et al.	361/737	7,074,061	B1 *	7/2006	Roth et al.	439/131
6,174,205	B1 *	1/2001	Madsen et al.	439/638	7,104,809	B1 *	9/2006	Huang	439/76.1
6,176,724	B1 *	1/2001	Klatt et al.	439/326	7,182,645	B2 *	2/2007	Shimizu et al.	439/630
6,193,163	B1 *	2/2001	Fehrman et al.	235/488	7,241,177	B1 *	7/2007	Lai	439/635
6,219,256	B1 *	4/2001	Wu	361/801	D553,130	S *	10/2007	Fiorentino	D14/356
6,250,965	B1 *	6/2001	Neifer	439/630	D560,911	S *	2/2008	Hackbart et al.	D3/273
6,276,943	B1 *	8/2001	Boutros et al.	439/76.1	7,341,461	B1 *	3/2008	Yen et al.	439/76.1
D451,501	S *	12/2001	Sward et al.	D14/242	7,401,172	B2 *	7/2008	Chang	710/106
D452,496	S *	12/2001	Murnaghan et al.	D14/242	7,454,541	B2 *	11/2008	Mills et al.	710/62
6,447,306	B1 *	9/2002	Paredes et al.	439/76.1	2001/0039129	A1 *	11/2001	Nishimura	439/74
6,457,647	B1 *	10/2002	Kurihashi et al.	235/486	2003/0048605	A1 *	3/2003	Kyozuka et al.	361/686
6,480,390	B2 *	11/2002	Matsumiya et al.	361/736	2003/0109179	A1 *	6/2003	Kaneshiro et al.	439/638
6,501,163	B1 *	12/2002	Utsumi	257/679	2003/0162445	A1 *	8/2003	Fujita et al.	439/638
6,577,500	B2 *	6/2003	Paredes et al.	361/686	2005/0079892	A1 *	4/2005	De Vos et al.	455/558
6,590,779	B2 *	7/2003	Ohki	361/737	2005/0239335	A1 *	10/2005	Kadonaga et al.	439/638

* cited by examiner

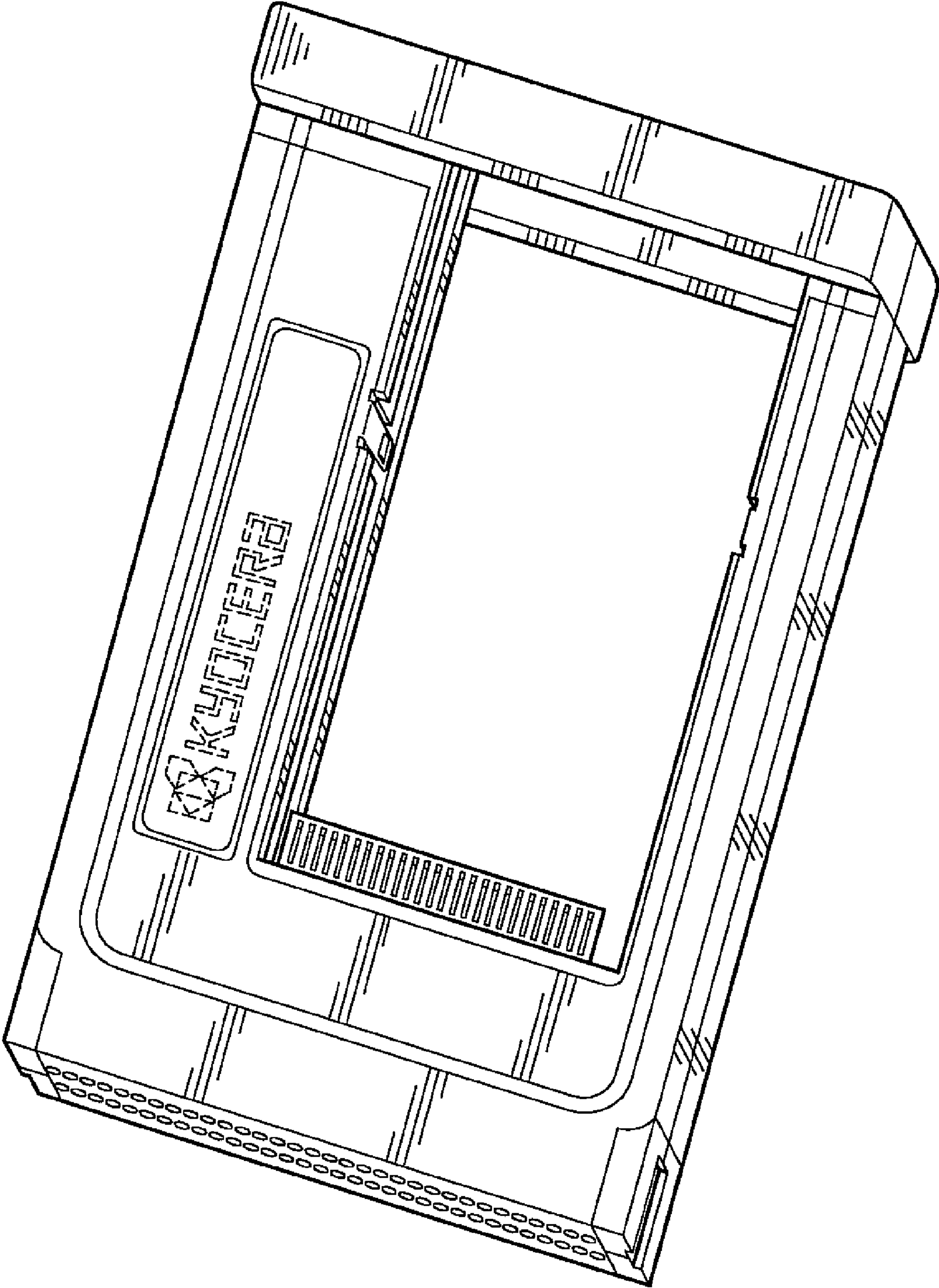

FIG. 1

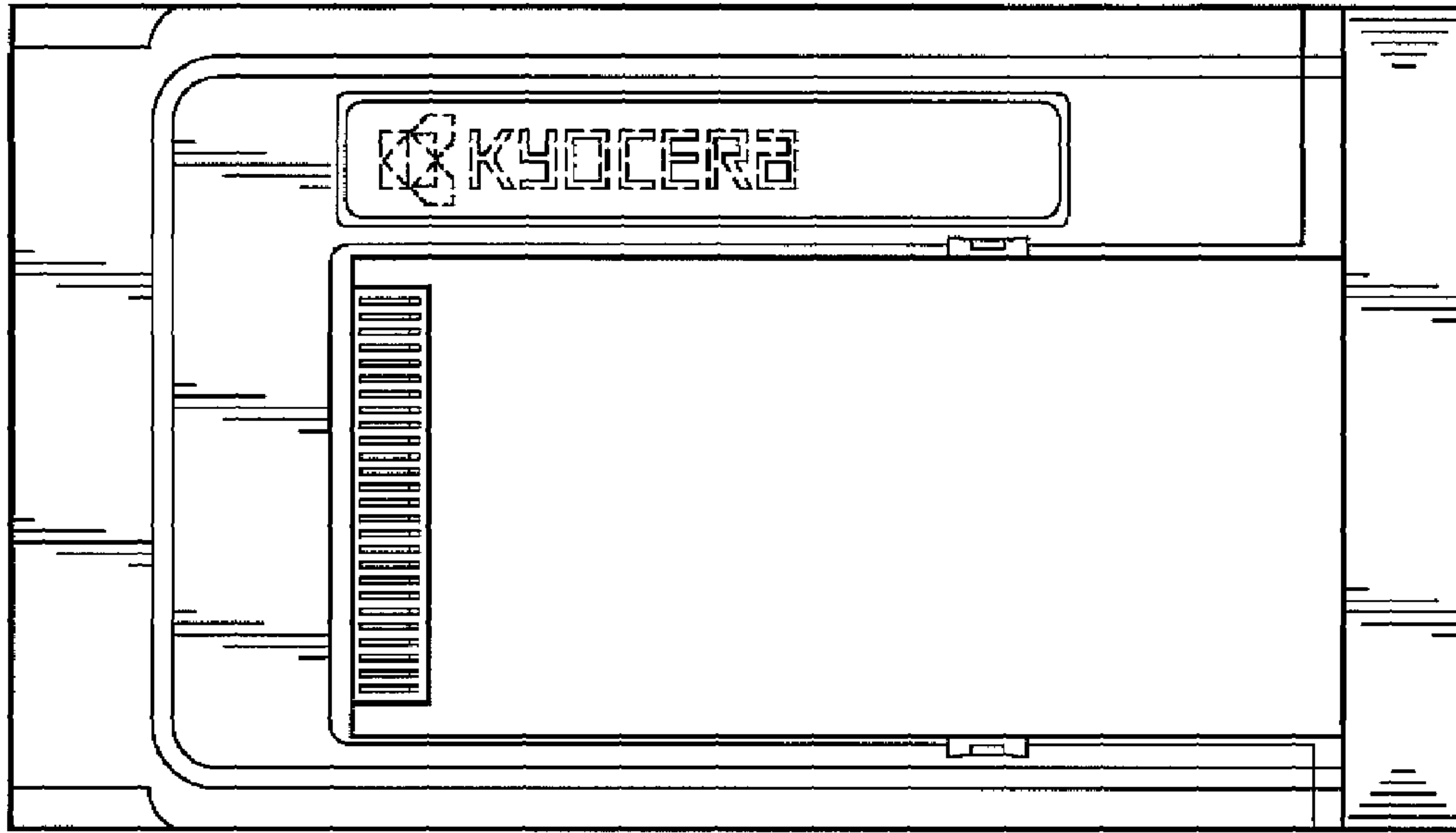

FIG. 2

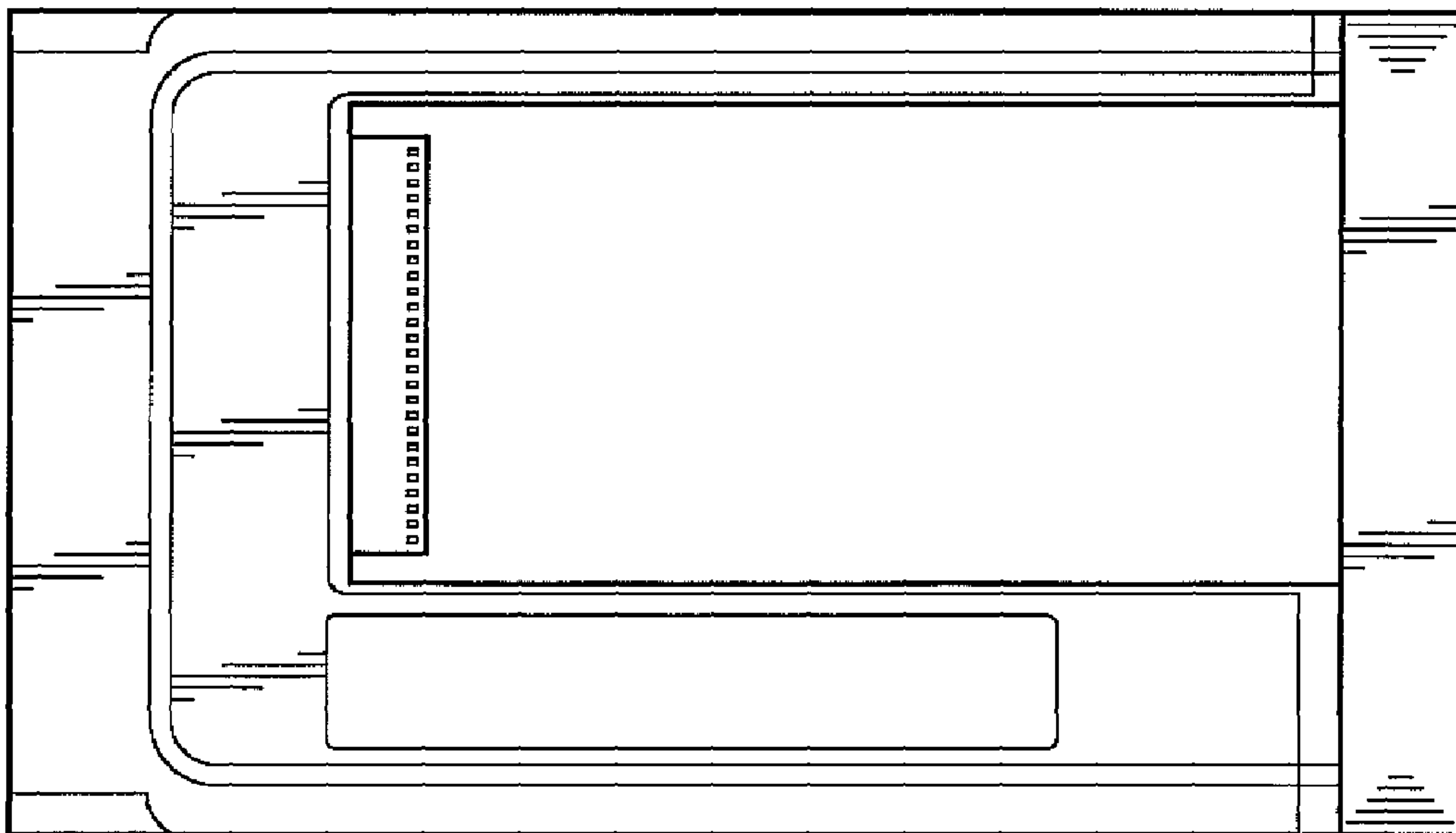

FIG. 3

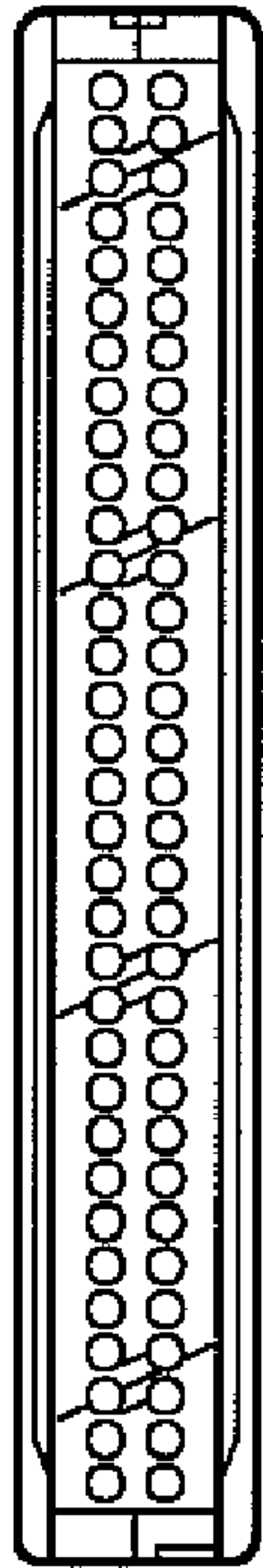

FIG. 4

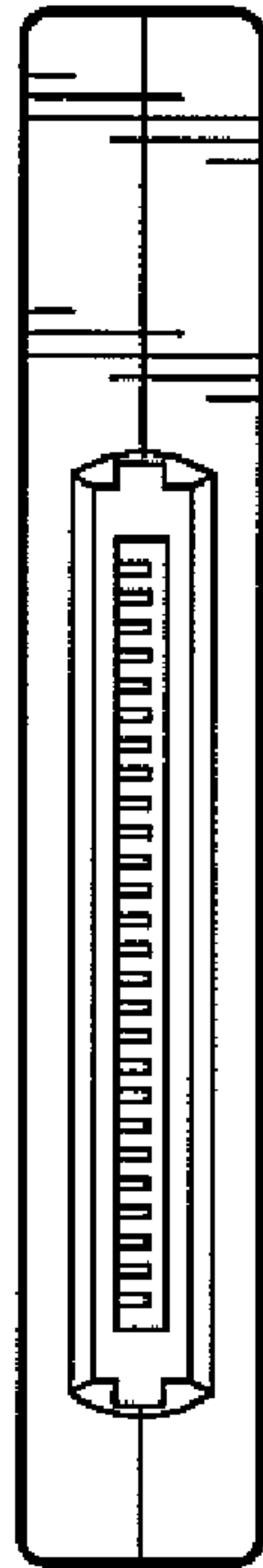

FIG. 5

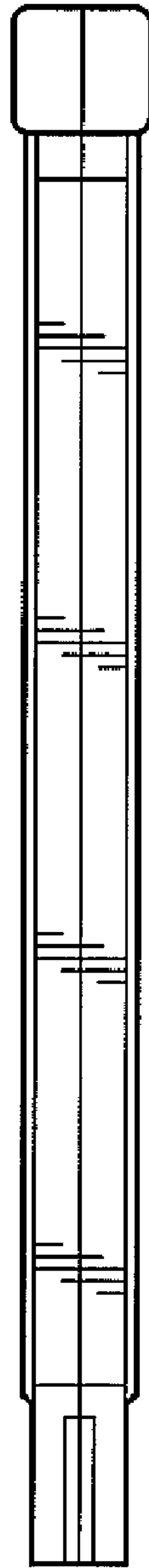

FIG. 6

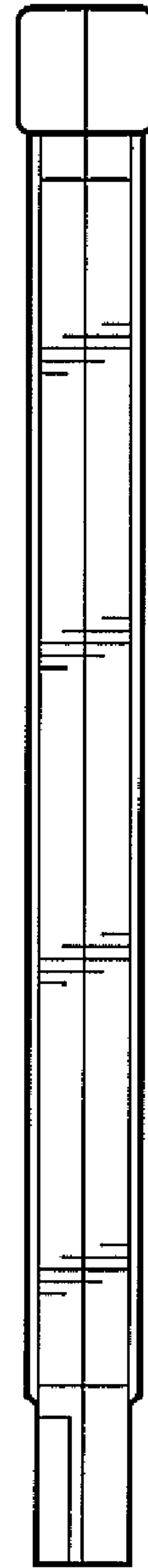

FIG. 7