



US00D607865S

(12) **United States Design Patent**  
**Lee et al.**

(10) **Patent No.:** **US D607,865 S**  
(45) **Date of Patent:** **\*\* Jan. 12, 2010**

(54) **MOBILE PHONE**

(75) Inventors: **Min-Hyouk Lee**, Seoul (KR); **Nam-Su Kim**, Seoul (KR); **Seog-Guen Kim**, Seoul (KR)

(73) Assignee: **Samsung Electronics Co., Ltd.**, Suwon (KR)

(\*\*) Term: **14 Years**

(21) Appl. No.: **29/333,194**

(22) Filed: **Mar. 4, 2009**

(30) **Foreign Application Priority Data**

Dec. 4, 2008 (KR) ..... 30-2008-0052223

(51) **LOC (9) Cl.** ..... **14-03**

(52) **U.S. Cl.** ..... **D14/138 AD; D14/138 G**

(58) **Field of Classification Search** ..... D14/138 R,  
D14/138 AD, 138 AC, 138 C, 138 G, 191,  
D14/203.1–203.8, 496, 138 AA, 138 AB,  
D14/247–248, 137, 147, 218, 341–347; D10/65,  
D10/78, 104; D13/168; D18/7; 455/566,  
455/575.1, 575.3

See application file for complete search history.

(56) **References Cited**

**U.S. PATENT DOCUMENTS**

D548,713 S \* 8/2007 Lee et al. .... D14/138 AD  
D552,580 S \* 10/2007 Mun ..... D14/138 AD  
D553,596 S \* 10/2007 Kim et al. .... D14/138 AD  
D558,720 S \* 1/2008 Lee et al. .... D14/138 AD  
D560,193 S \* 1/2008 Sung et al. .... D14/138 AD  
D563,933 S \* 3/2008 Lee et al. .... D14/138 AB  
D568,286 S \* 5/2008 Suk et al. .... D14/138 G  
D571,234 S \* 6/2008 Reeson et al. .... D10/65  
D577,298 S \* 9/2008 Reeson et al. .... D10/65  
D578,503 S \* 10/2008 Shin et al. .... D14/138 AD  
D580,396 S \* 11/2008 Kang ..... D14/138 G  
D581,894 S \* 12/2008 Kim ..... D14/138 G  
D582,377 S \* 12/2008 Kim et al. .... D14/138 AD

D585,040 S \* 1/2009 Kim et al. .... D14/138 G  
D585,044 S \* 1/2009 Seo et al. .... D14/138 AD  
D585,411 S \* 1/2009 Eaton ..... D14/138 G

(Continued)

**OTHER PUBLICATIONS**

HTC Touch HD, announced Sep. 2008, [online], [retrieved on Sep. 19, 2008]. Retrieved from Internet ,<URL: http://www.gsmarena.com>.\*

(Continued)

*Primary Examiner*—Jeffrey D Asch

*Assistant Examiner*—Bridget L Eland

(74) *Attorney, Agent, or Firm*—Staas & Halsey LLP

(57) **CLAIM**

The ornamental design for mobile phone, as shown and described.

**DESCRIPTION**

FIG. 1 is a front perspective view of a mobile phone;  
FIG. 2 is a front view of the mobile phone of FIG. 1;  
FIG. 3 is a rear view of the mobile phone of FIG. 1;  
FIG. 4 is a left-side view of the mobile phone of FIG. 1;  
FIG. 5 is a right-side view of the mobile phone of FIG. 1;  
FIG. 6 is a top plan view of the mobile phone of FIG. 1;  
FIG. 7 is a bottom plan view of the mobile phone of FIG. 1;  
FIG. 8 is a front open view of the mobile phone of FIG. 1; and,  
FIG. 9 is a perspective open view of the mobile phone of FIG. 1.

**1 Claim, 6 Drawing Sheets**

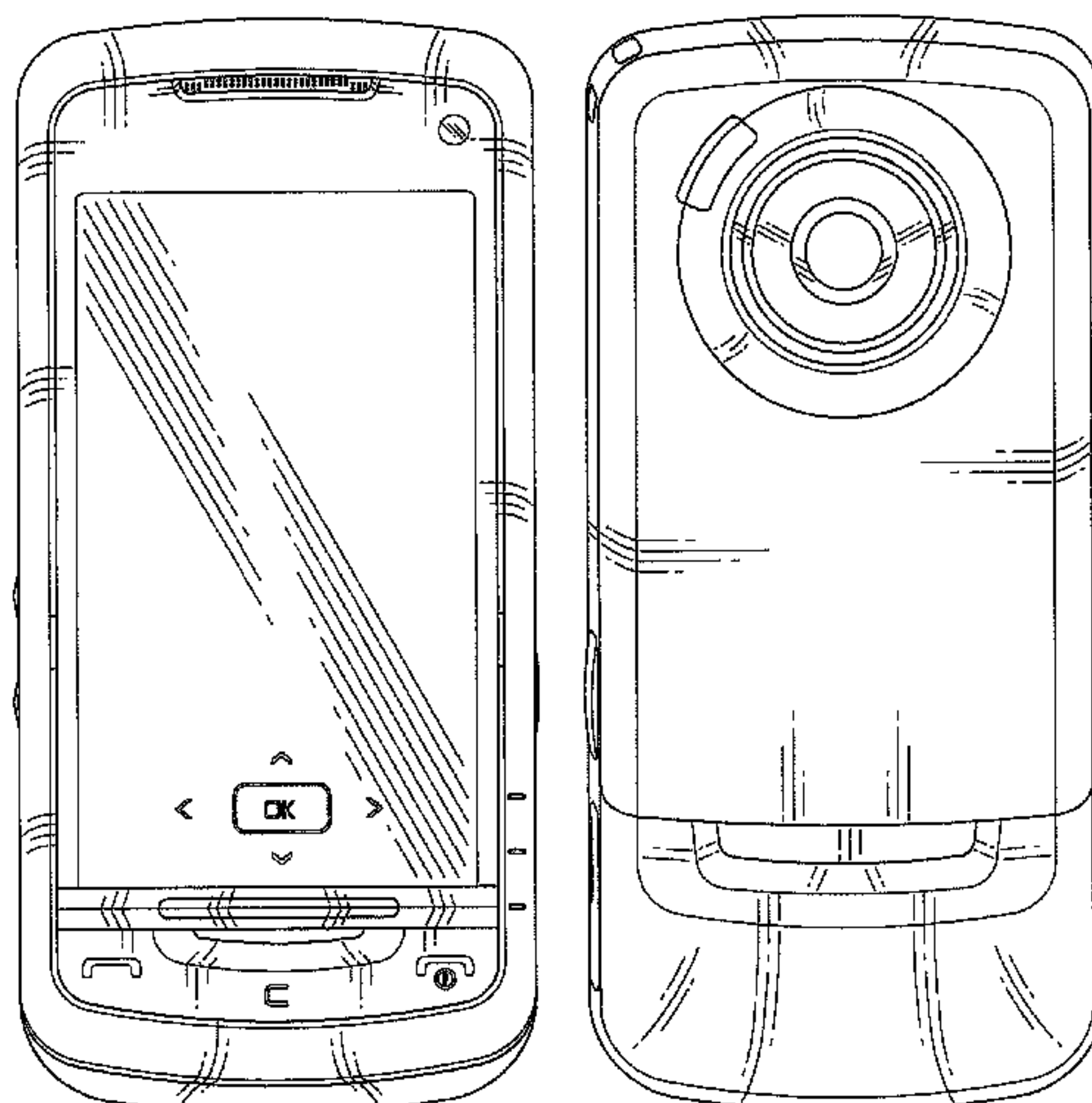

# US D607,865 S

Page 2

---

## U.S. PATENT DOCUMENTS

D589,924 S \* 4/2009 Jung et al. .... D14/138 AD  
D590,802 S \* 4/2009 Shin et al. .... D14/138 AD  
D592,166 S \* 5/2009 Song ..... D14/138 AD  
D594,433 S \* 6/2009 Seo et al. .... D14/138 AD  
D596,608 S \* 7/2009 Kim et al. .... D14/138 G  
2007/0218963 A1\* 9/2007 Kim ..... 455/575.4  
2008/0076480 A1\* 3/2008 Jeong et al. .... 455/566  
2008/0096616 A1\* 4/2008 Choi ..... 455/575.1  
2008/0132288 A1\* 6/2008 Misawa ..... 455/566  
2008/0242359 A1\* 10/2008 Seol et al. .... 455/566

## OTHER PUBLICATIONS

i-mobile TV650 Touch, announced Jul. 2009, [online], [retrieved on Jul. 20, 2009]. Retrieved from Internet ,<URL: <http://www.gsmarena.com>>.\*  
LG KU970 Shine, announced Feb. 2007, [online], [retrieved on Feb. 20, 2007]. Retrieved from Internet ,<URL: <http://www.gsmarena.com>>.\*  
Samsung i8910 Omnia HD, announced Feb. 2009, [online], [retrieved on Feb. 20, 2009]. Retrieved from Internet ,<URL: <http://www.gsmarena.com>>.\*

\* cited by examiner

FIG. 1

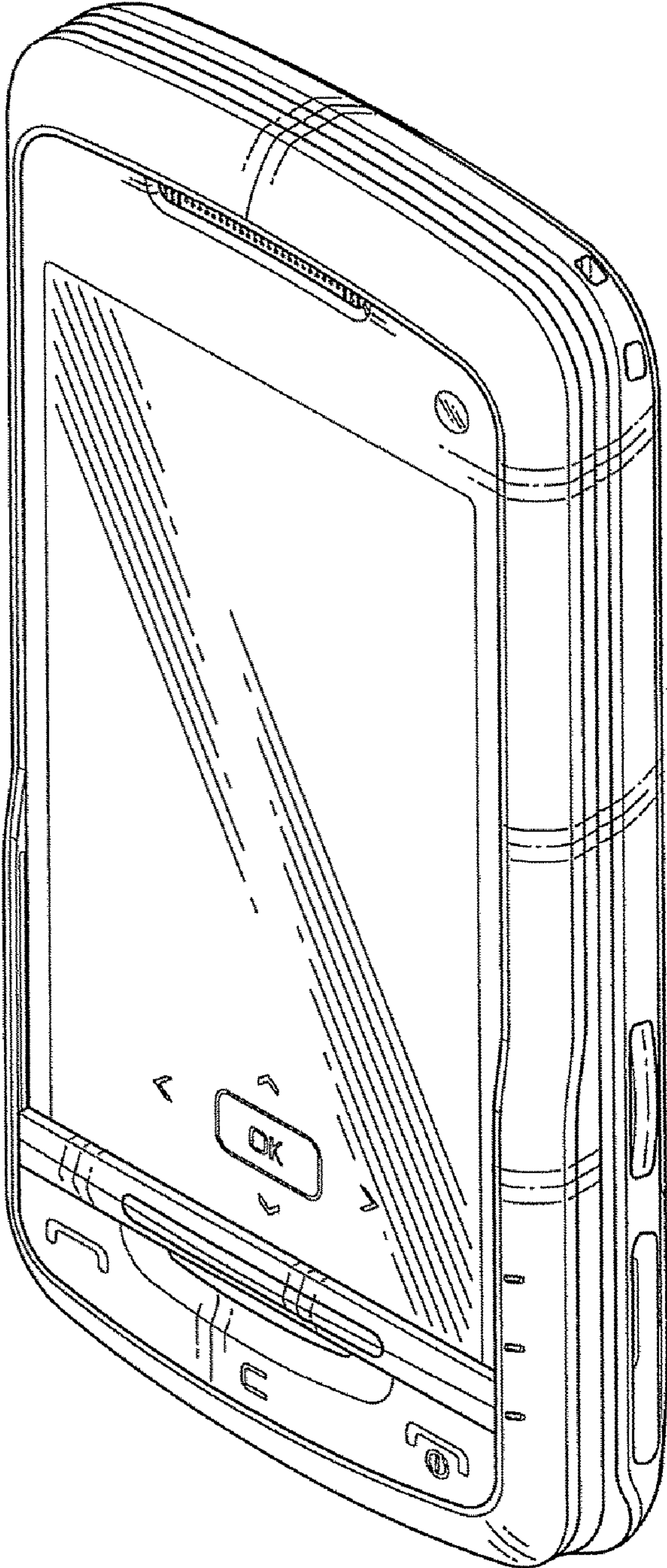



FIG. 2

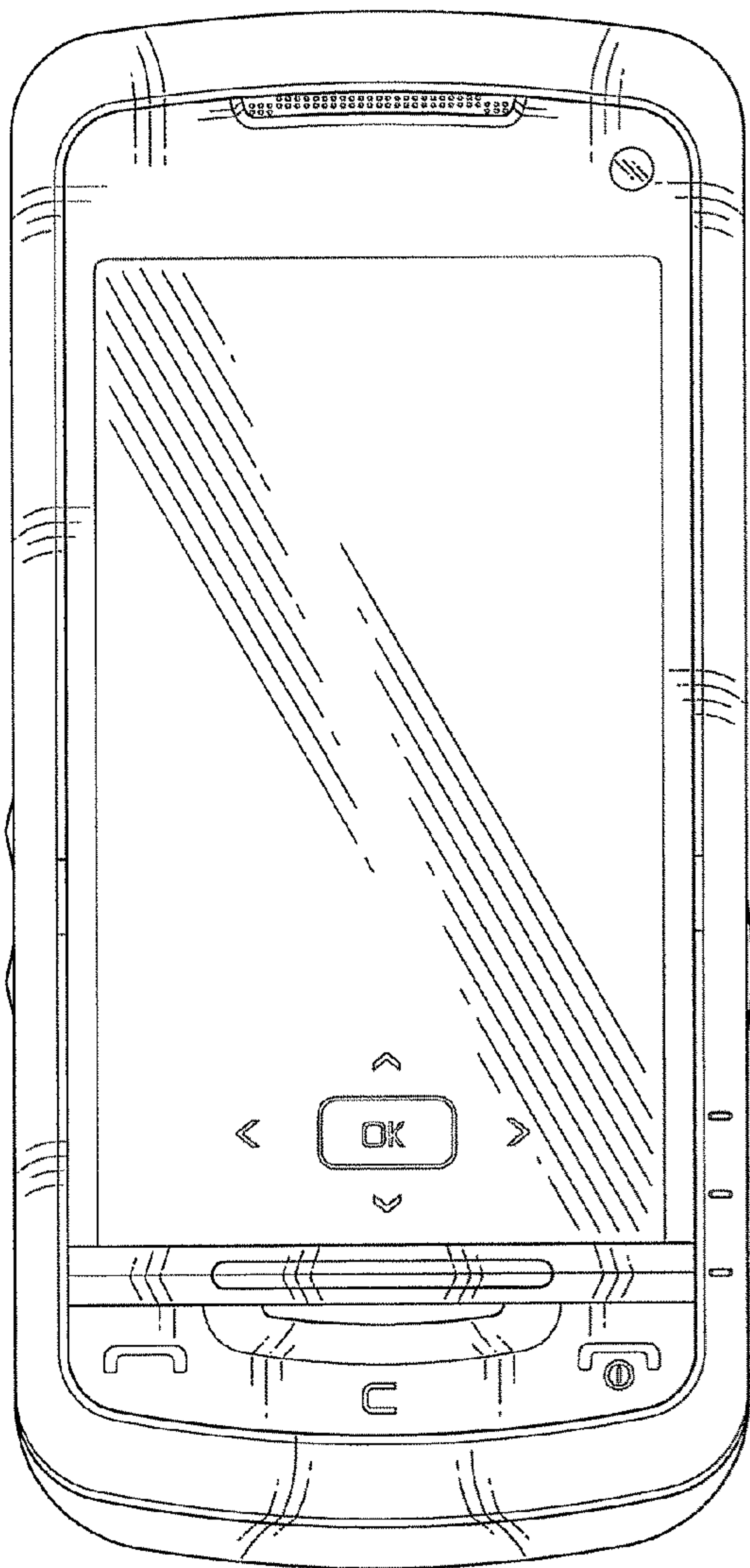

FIG. 3

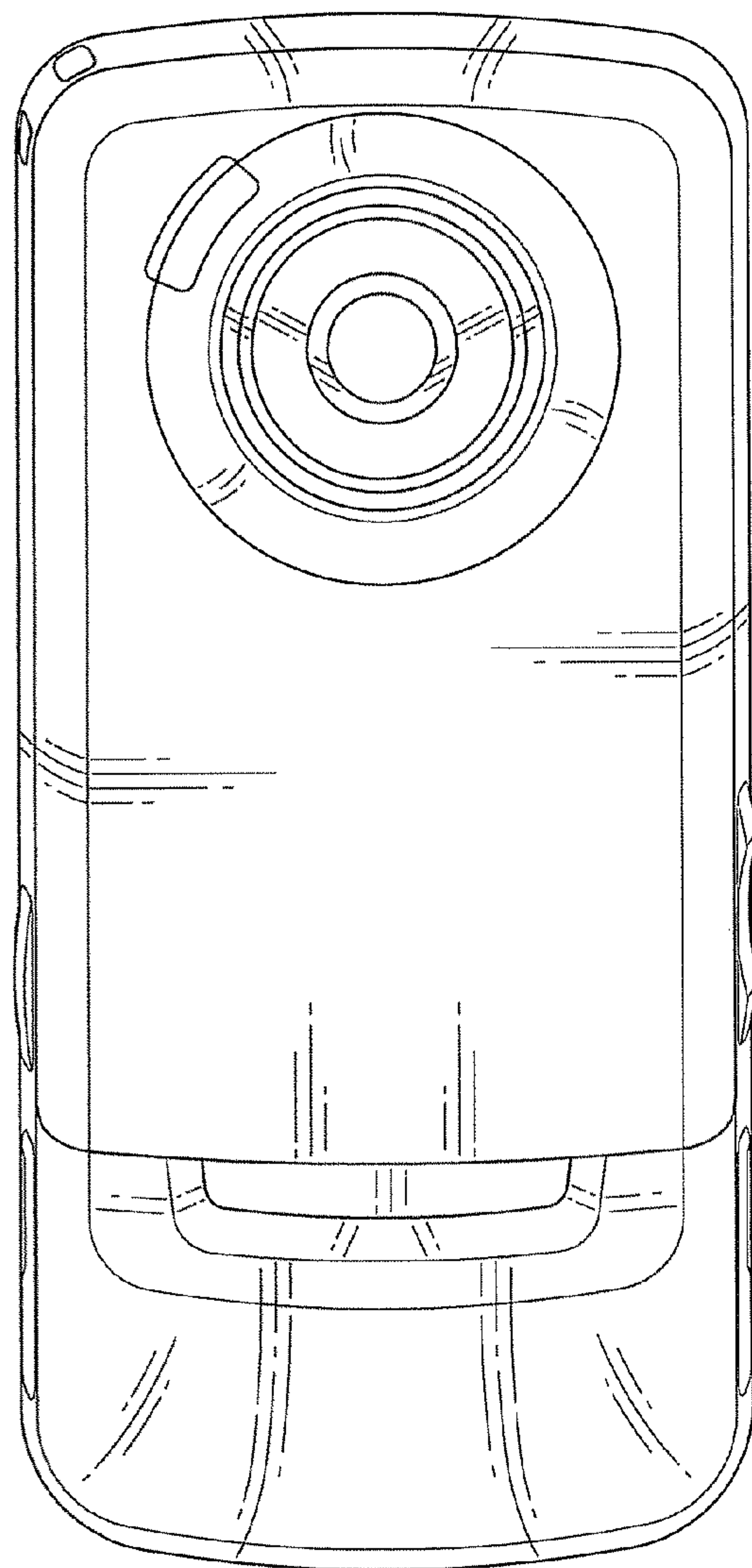

FIG. 4

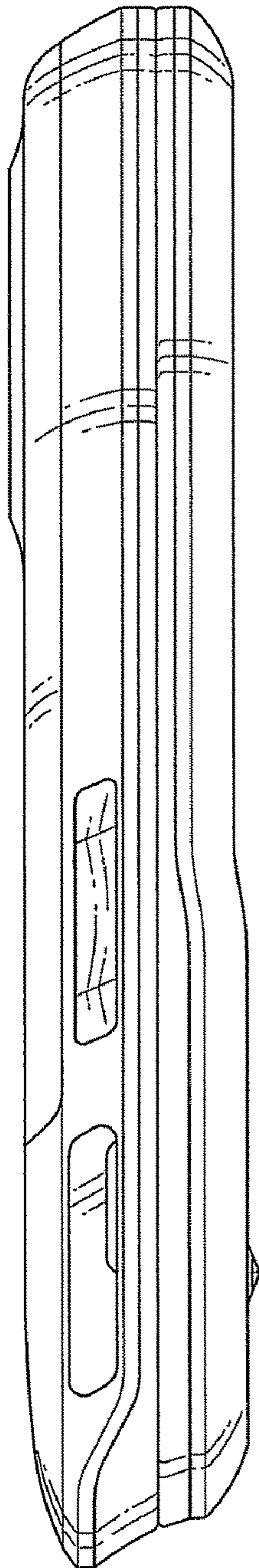

FIG. 5

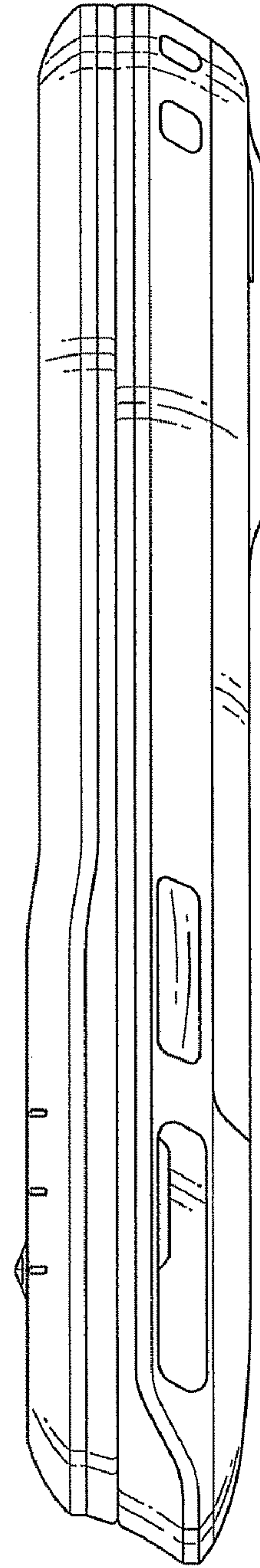

FIG. 6

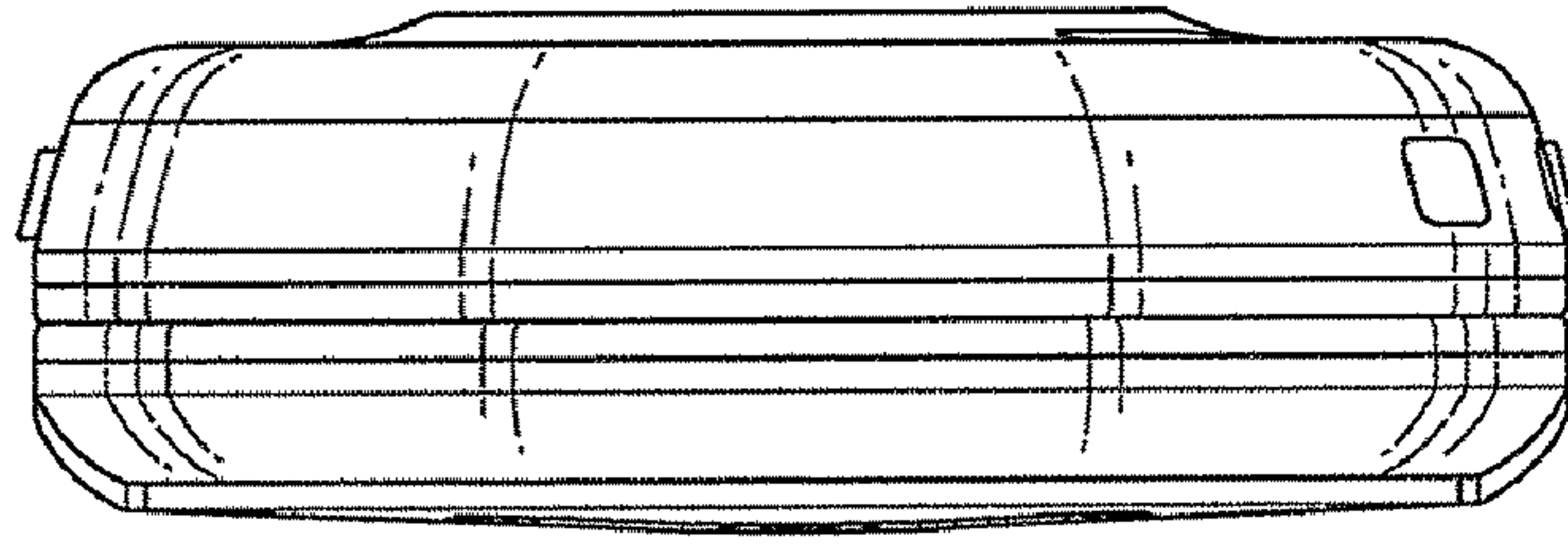

FIG. 7

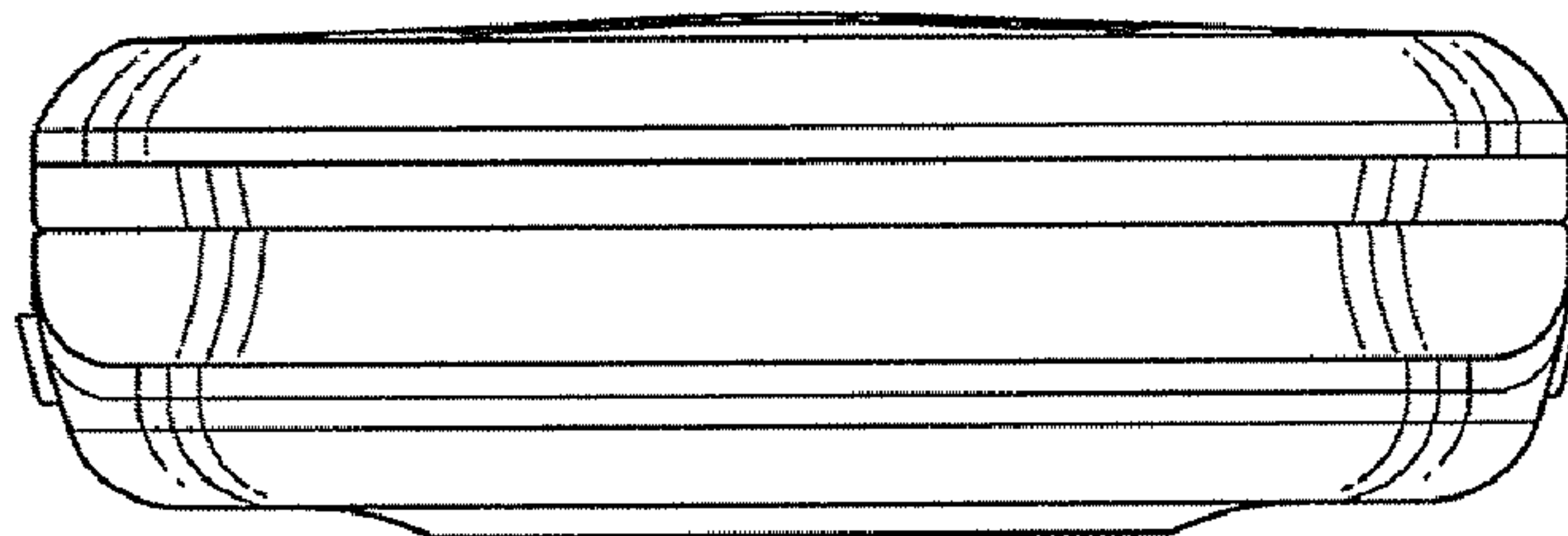

FIG. 8

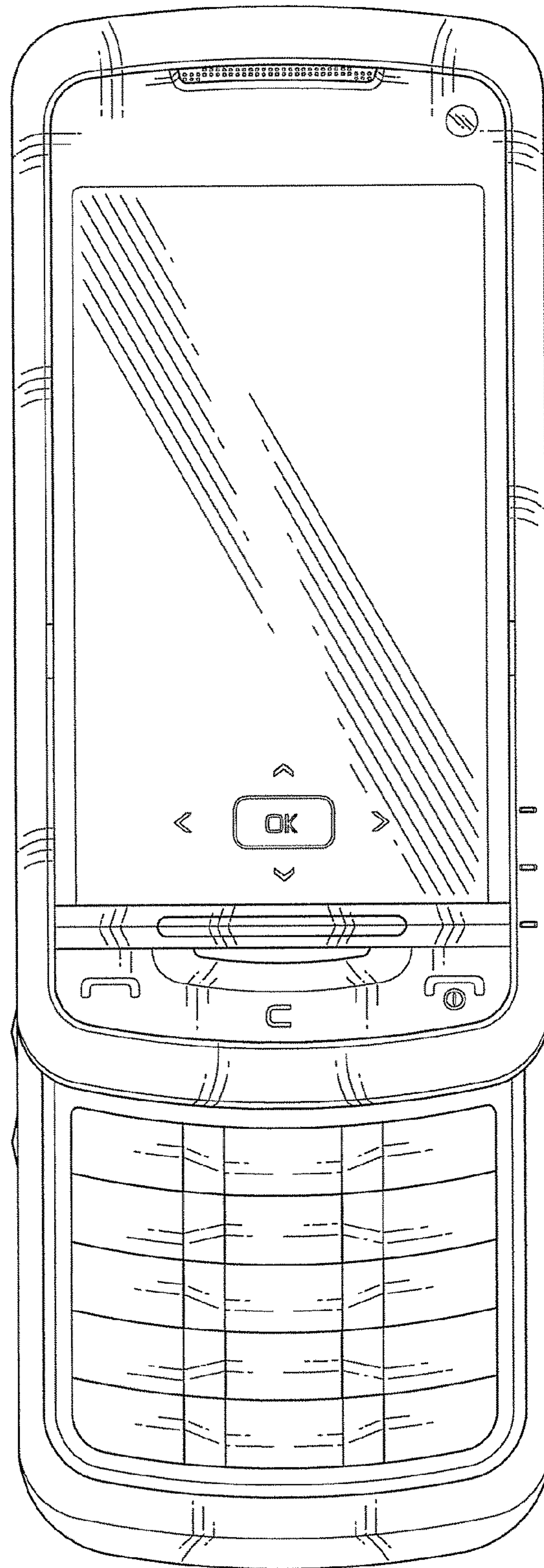



FIG. 9

