

US00D607703S

(12) **United States Design Patent**
Pagliari

(10) **Patent No.:** **US D607,703 S**
(45) **Date of Patent:** **** Jan. 12, 2010**

(54) **MULTI-SIZED OFFSET HANDLE TONGUE AND GROOVE PLIERS**

(76) Inventor: **Marin D. Pagliari**, 509 Dunbarton Cir., Sacramento, CA (US) 95825

(**) Term: **14 Years**

(21) Appl. No.: **29/314,055**

(22) Filed: **Mar. 2, 2009**

(51) **LOC (9) Cl.** **08-05**

(52) **U.S. Cl.** **D8/52**

(58) **Field of Classification Search** D8/1, D8/4, 14, 51-58, 60, 105-107; D24/133, D24/148, 153; D22/149, 150, 199; 81/300, 81/318, 324, 326, 385, 393, 407, 415-418, 81/420, 424.5, 426, 426.5, 427, 427.5
See application file for complete search history.

(56) **References Cited**

U.S. PATENT DOCUMENTS

97,399	A *	11/1869	Holmes	81/418
181,175	A *	8/1876	Huntoon	81/418
1,506,675	A *	8/1924	Seppmann	81/426.5
1,612,474	A *	12/1926	Strain	81/418
2,136,414	A *	11/1938	Clements	606/174
2,882,775	A *	4/1959	Rank et al.	81/414
3,391,690	A *	7/1968	Armao	D24/148
4,726,265	A *	2/1988	Reich	81/407
D310,714	S *	9/1990	Dolwick	D24/148
D417,376	S *	12/1999	Schmithorst	D8/57
6,019,020	A *	2/2000	Liou	81/407
D423,894	S *	5/2000	Schmithorst	D8/57
D427,037	S *	6/2000	Schmithorst	D8/57
D457,040	S *	5/2002	Hirschfeld	D8/4
7,100,480	B2 *	9/2006	Engvall et al.	81/413
7,174,816	B1 *	2/2007	Di Bitonto et al.	81/407
D546,152	S *	7/2007	Williams et al.	D8/52
D588,890	S *	3/2009	Picaza Ibarondo	D8/52
2004/0159194	A1 *	8/2004	Ting	81/416

* cited by examiner

Primary Examiner—Cathron C Brooks
Assistant Examiner—Deanna Fluegeman
(74) *Attorney, Agent, or Firm*—Mark C. Jacobs

(57) **CLAIM**

The ornamental design for multi-sized offset handle tongue and groove pliers, as shown and described.

DESCRIPTION

FIG. 1 is a perspective view of the first embodiment of my design.

FIG. 2 is a front view thereof.

FIG. 3 is a rear view thereof.

FIG. 4 is the top plan view thereof.

FIG. 5 is a left side elevational view thereof; the left side elevational views of embodiments 2 and 3 being identical to this view.

FIG. 6 is a bottom view thereof.

FIG. 7 is a right side elevational view thereof; the right side elevational views of embodiments 2 and 3 being identical to this view.

FIG. 8 is a perspective view of the second embodiment of my design.

FIG. 9 is a front view of this second embodiment.

FIG. 10 is a rear view thereof.

FIG. 11 is a top plan view thereof.

FIG. 12 is a bottom plan view thereof.

FIG. 13 is a perspective view of the third embodiment of my design.

FIG. 14 is a front elevational view thereof.

FIG. 15 is is a rear view thereof.

FIG. 16 is a top plan view thereof.

FIG. 17 is a bottom plan view thereof.

FIG. 18 is a perspective view of the fourth embodiment of my design.

FIG. 19 is a front view thereof.

FIG. 20 is a rear view thereof.

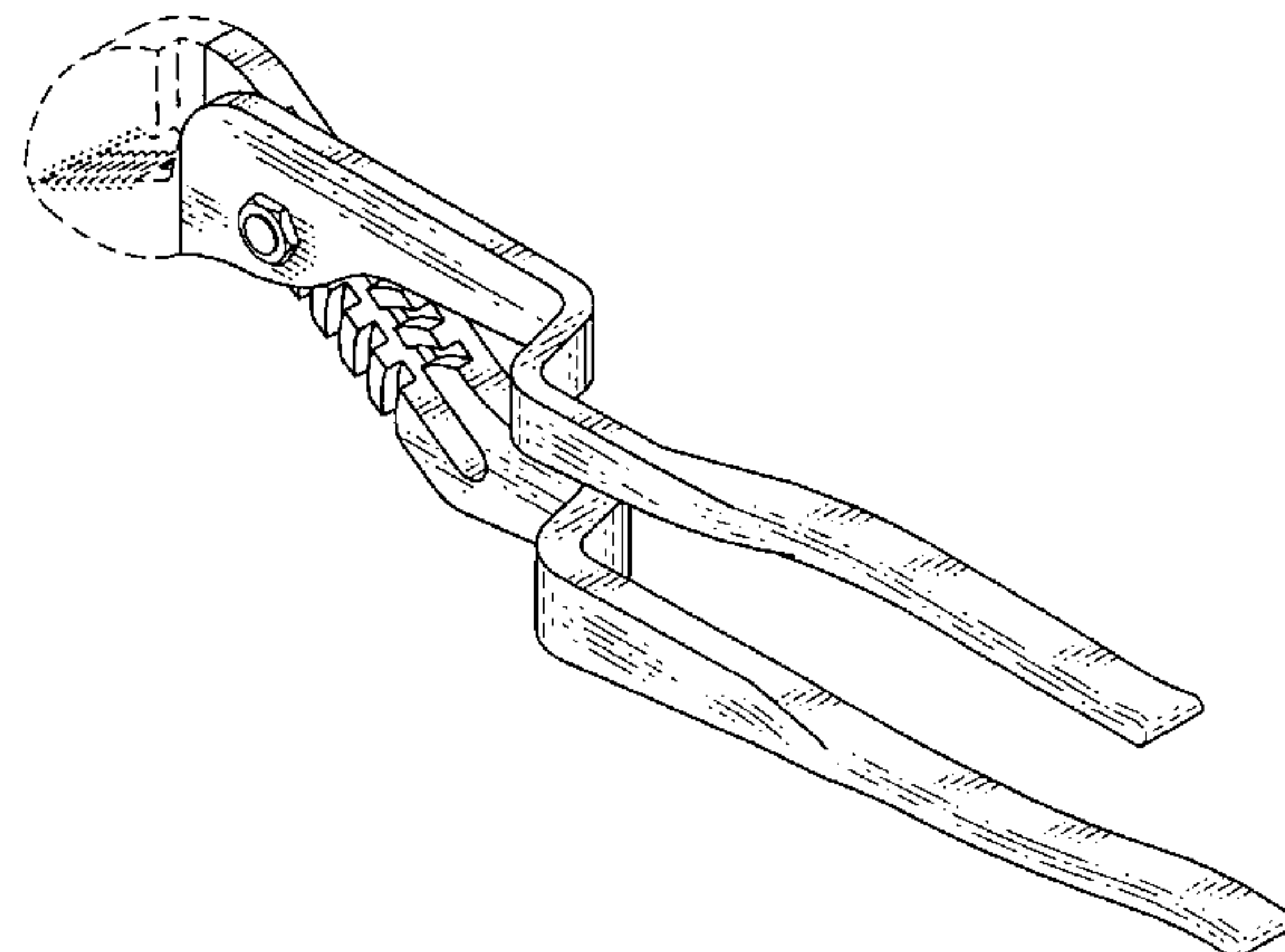
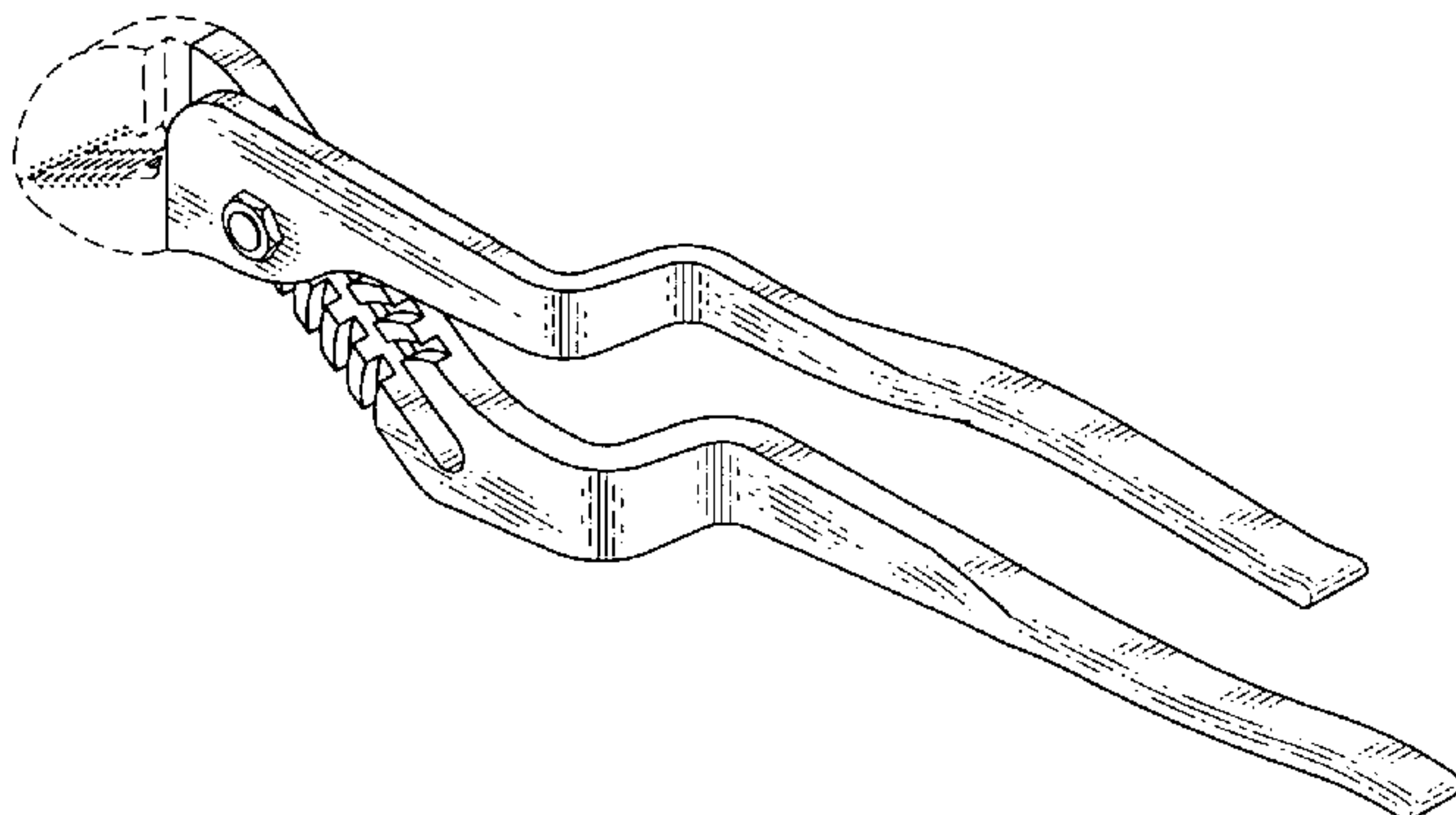

FIG. **21** is a top plan view of the right hand version of the first embodiment.

FIG. **22** is a left side elevational view thereof; the left side elevational views of embodiments **5** and **6** being identical to this view.

FIG. **23** is a bottom view thereof.

FIG. **24** is a right side elevational view thereof; the right side elevational views of embodiments **5** and **6** being identical to this view.

FIG. **25** is a perspective view of the fifth embodiment of my design.

FIG. **26** is a front view thereof.

FIG. **27** is a rear view thereof.

FIG. **28** is a top plan view thereof.

FIG. **29** is a bottom plan view thereof.

FIG. **30** is a perspective view of the sixth embodiment of my design.

FIG. **31** is a front elevational view thereof.

FIG. **32** is is a rear view thereof.

FIG. **33** is a top plan view thereof; and,

FIG. **34** is a bottom plan view thereof.

FIGS. **1–17** depict views of left hand user tools of this design, while FIGS. **18–34** depict views of right hand user tools of this design.

The broken lines in the drawings illustrate unclaimed portions of the pliers and form no part of the claimed design.

1 Claim, 6 Drawing Sheets

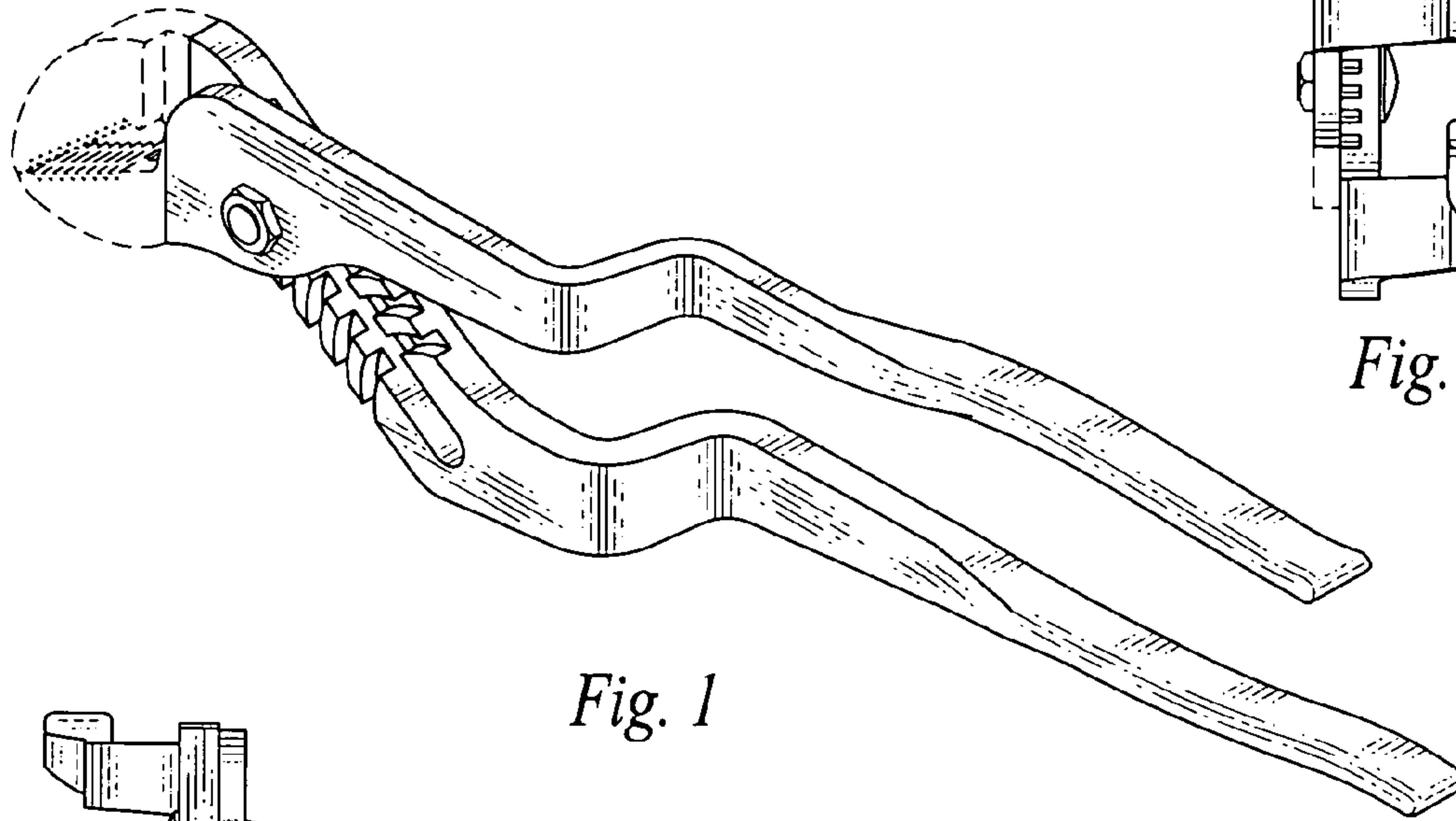

Fig. 1

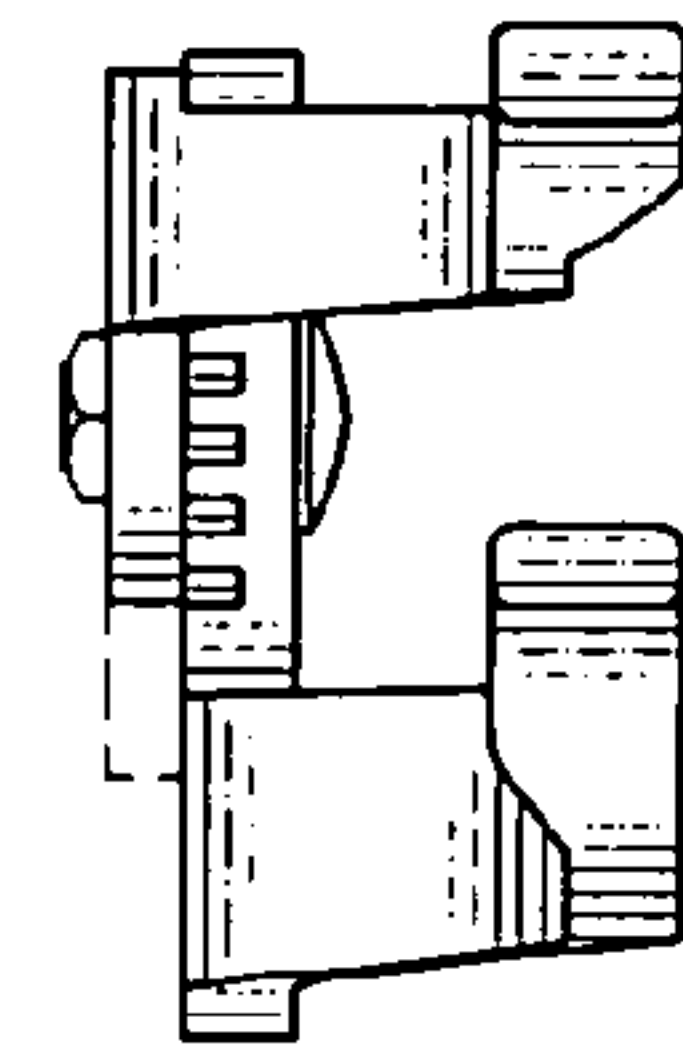

Fig. 3

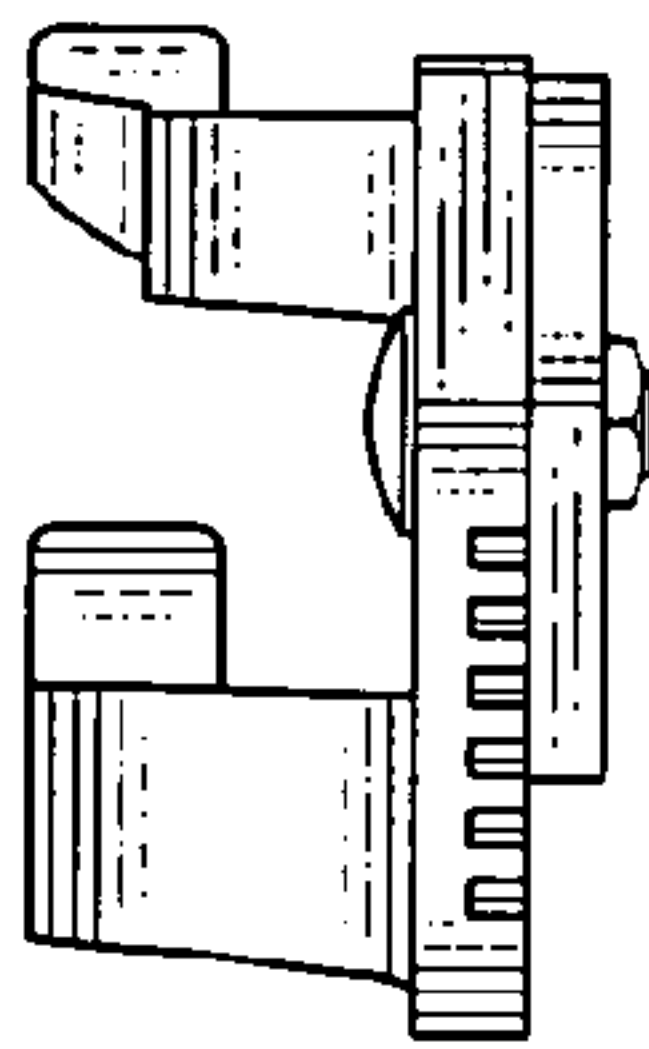

Fig. 2

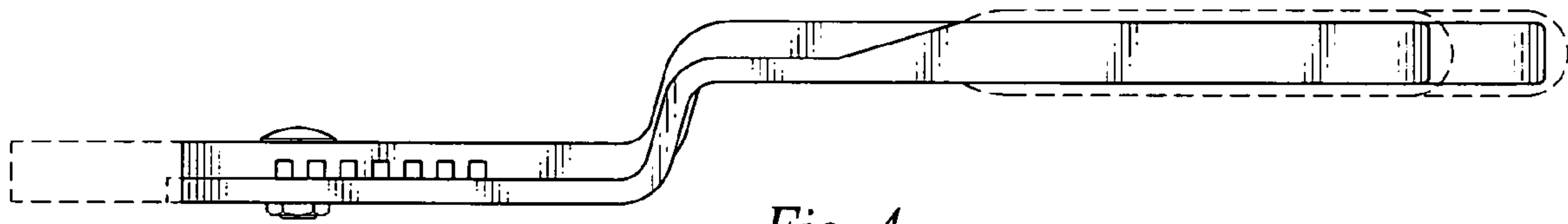

Fig. 4

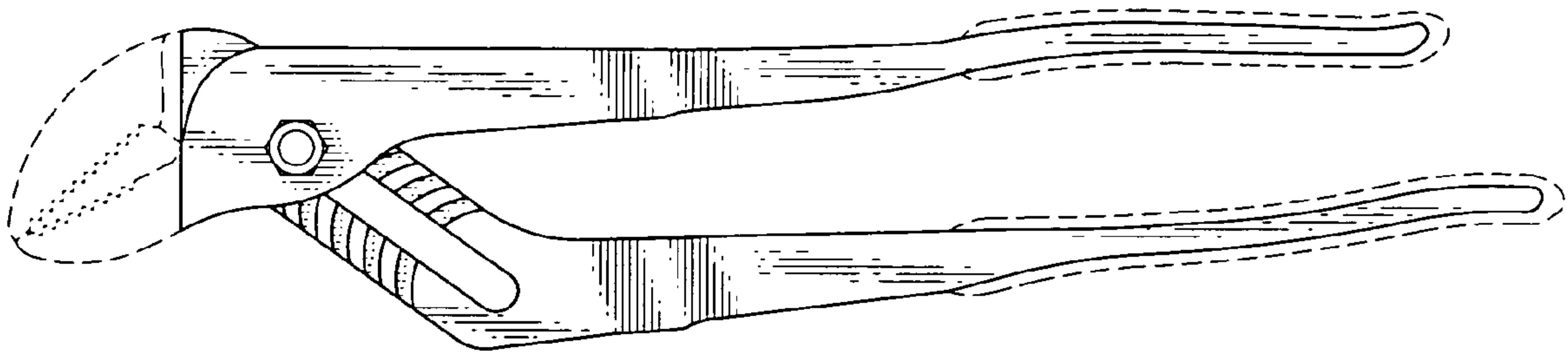

Fig. 5

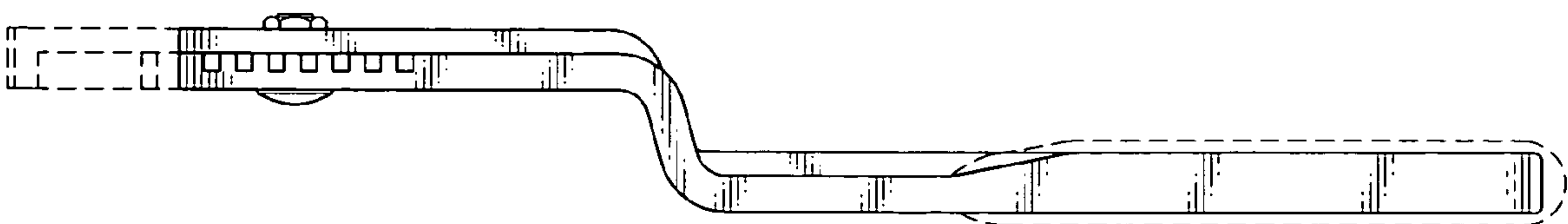

Fig. 6

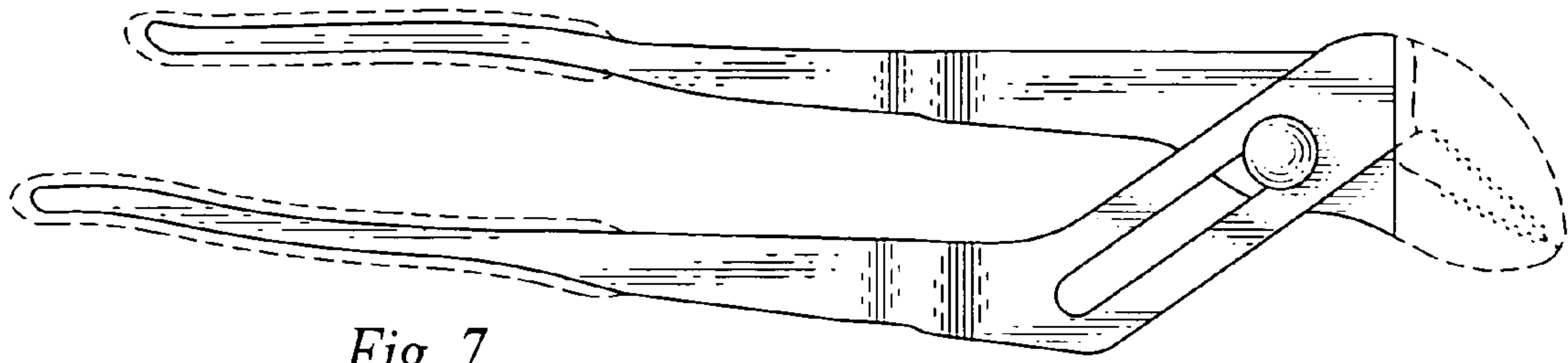

Fig. 7

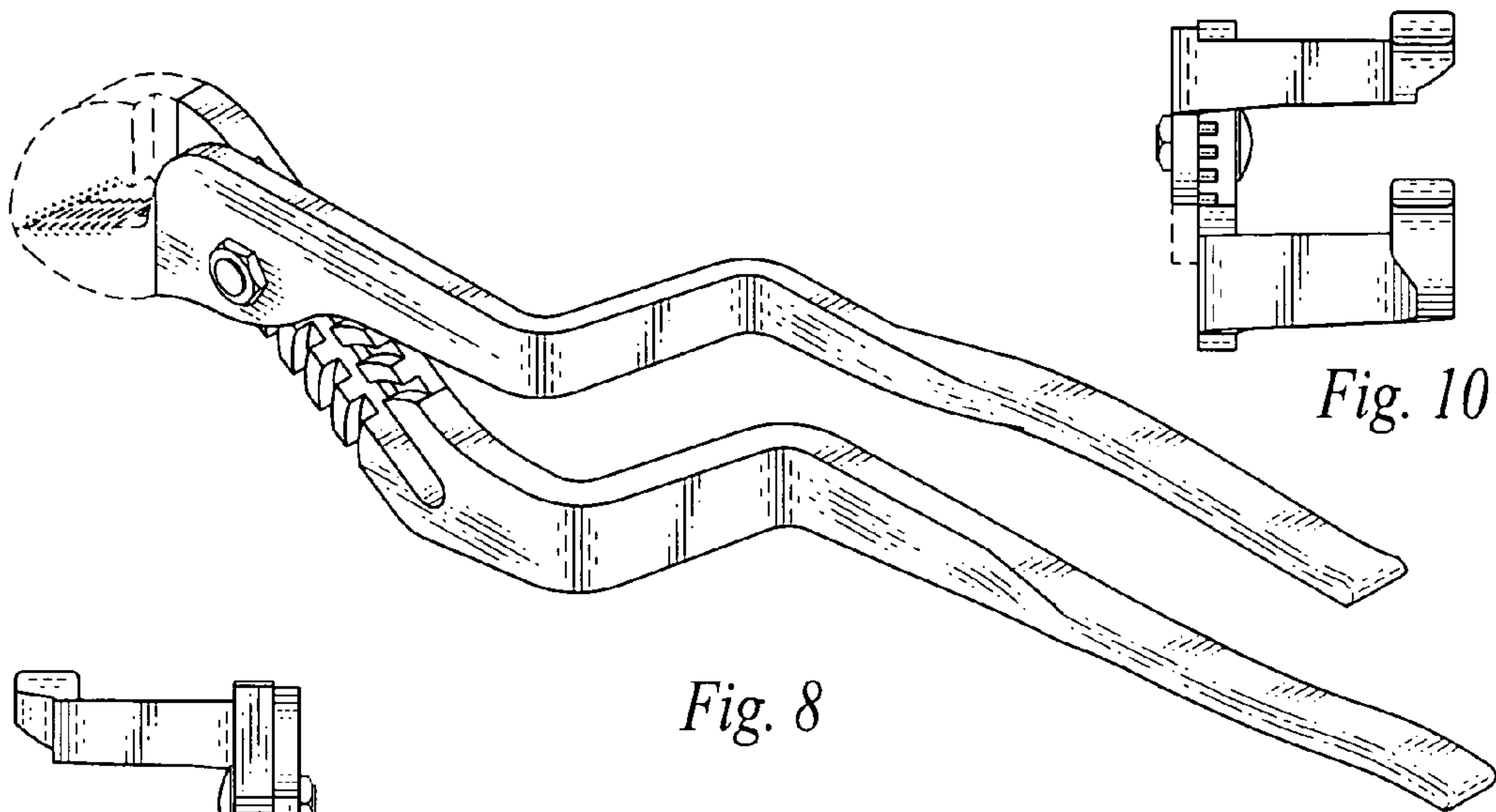

Fig. 8

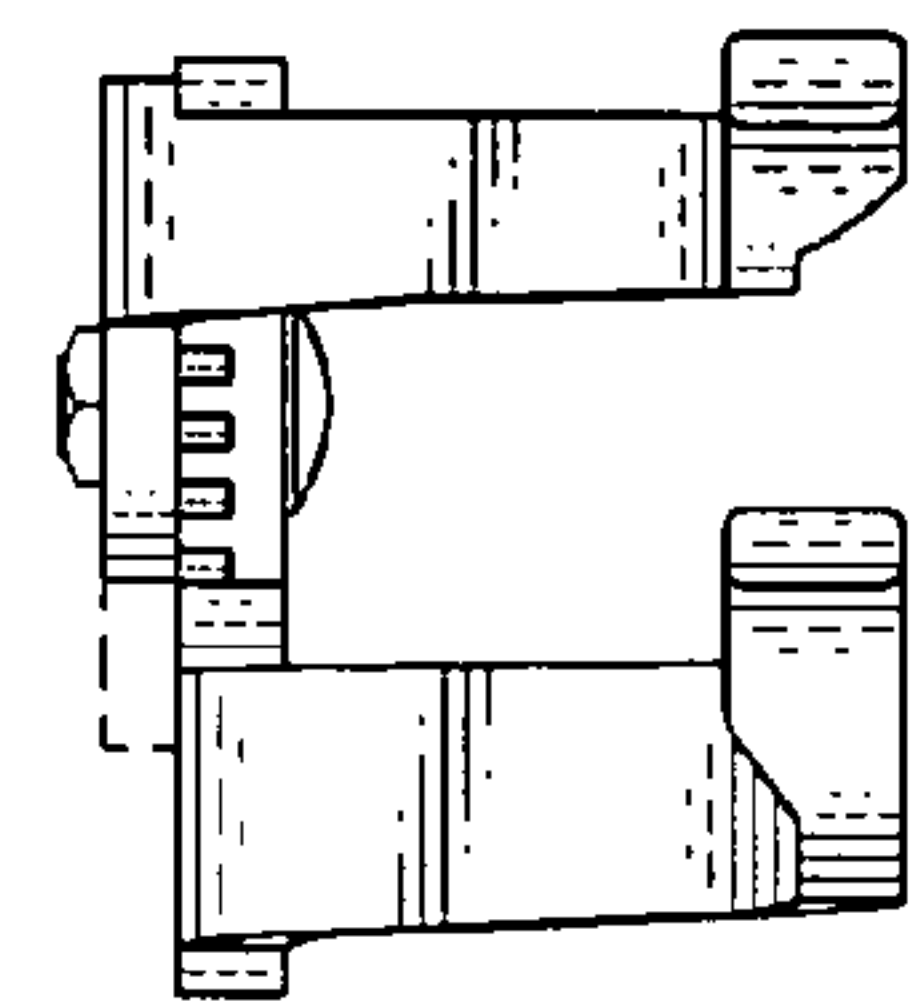

Fig. 10

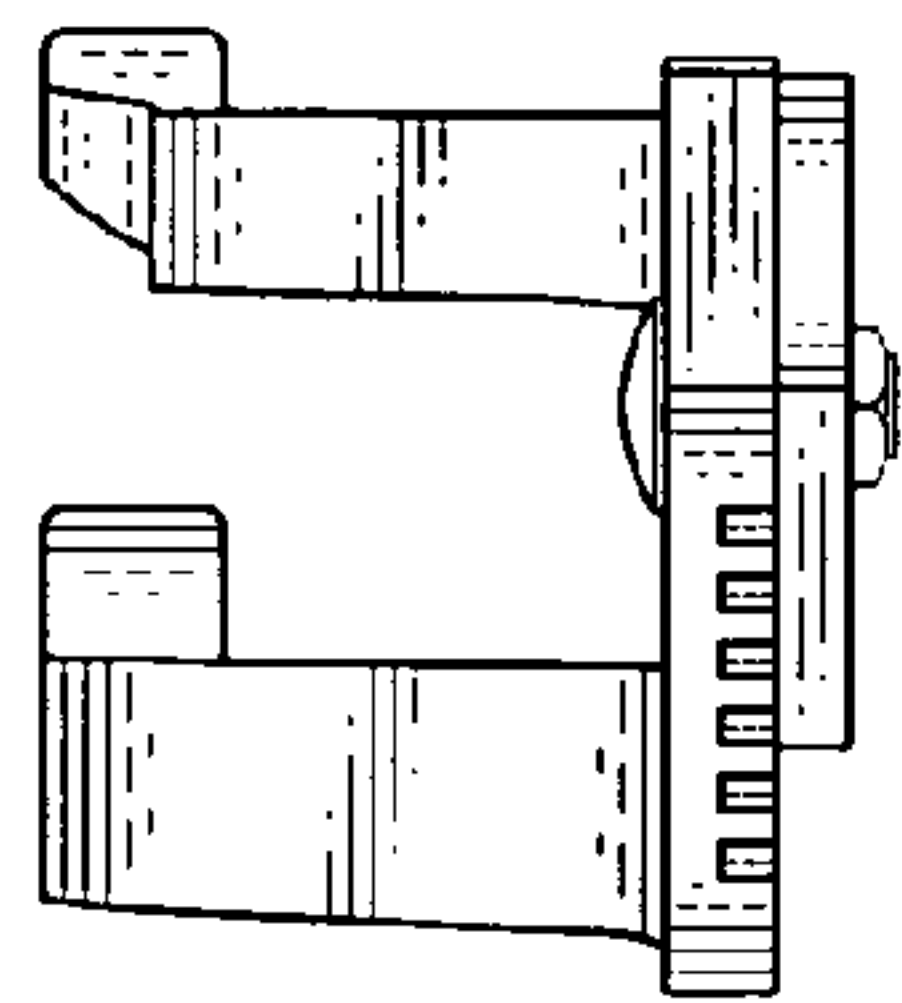

Fig. 9

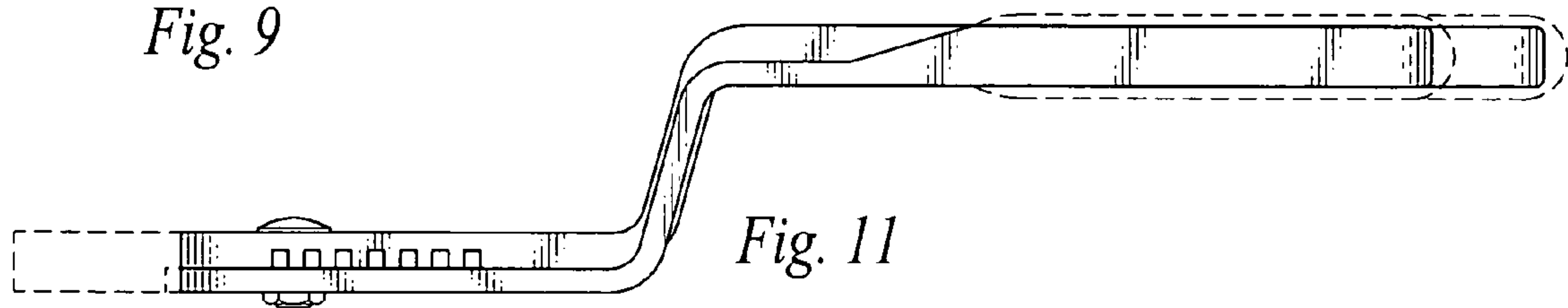

Fig. 11

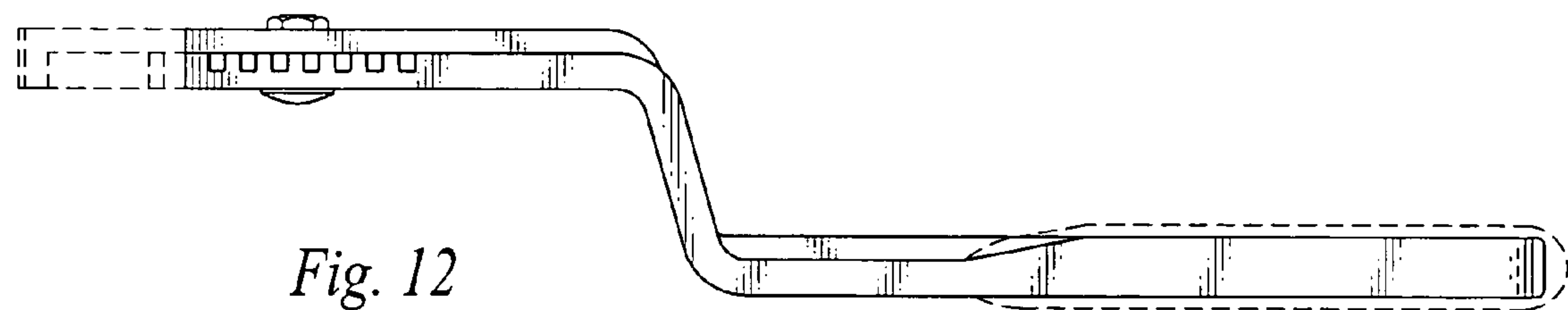

Fig. 12

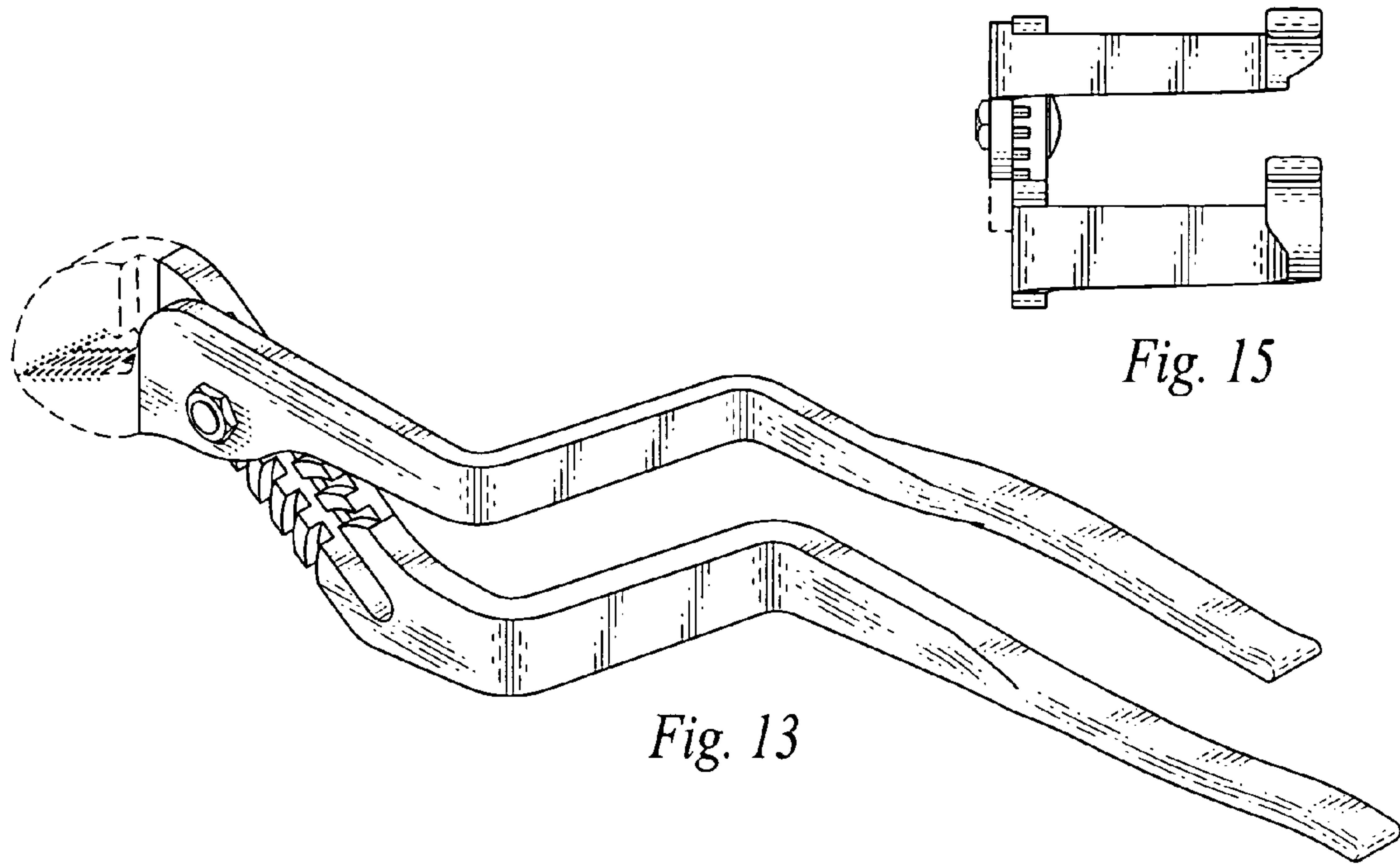

Fig. 13

Fig. 15

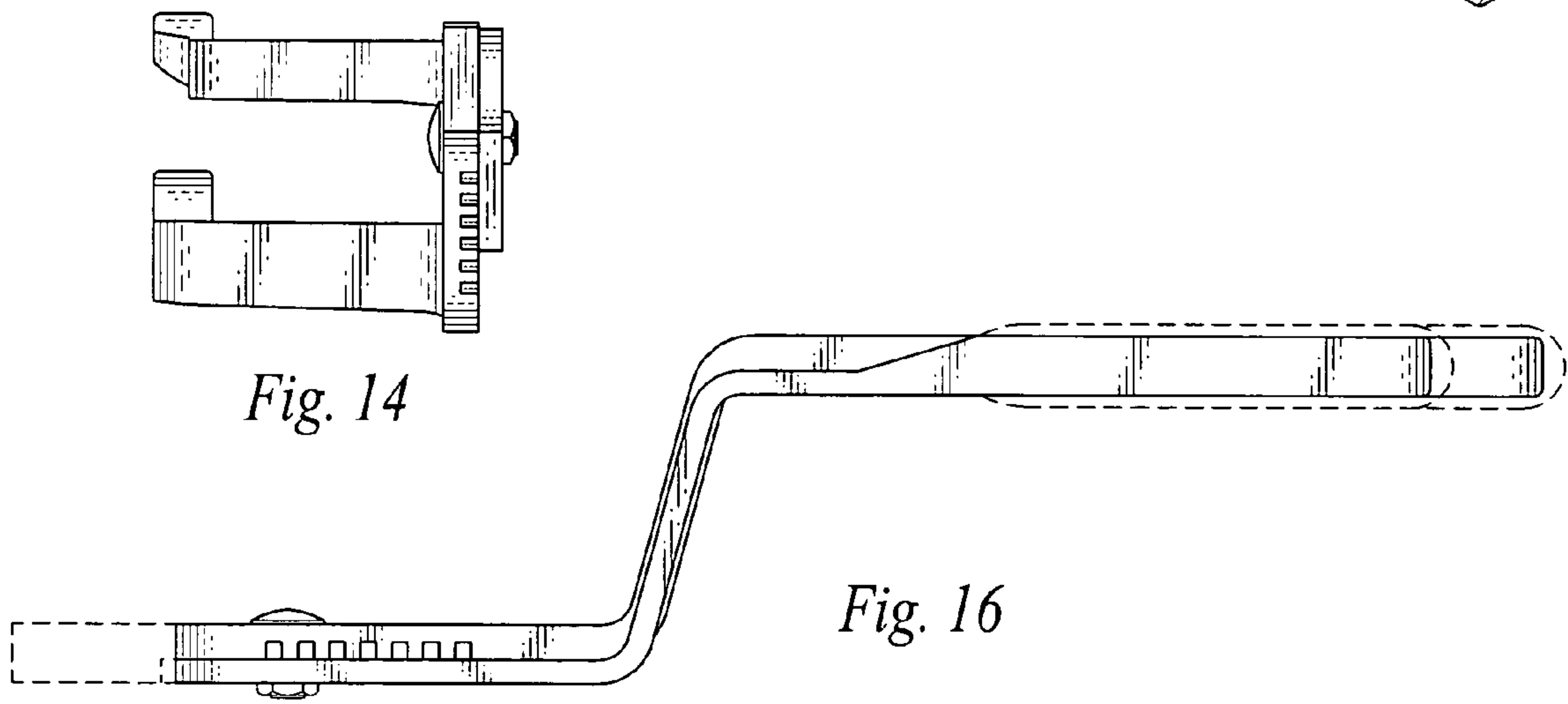

Fig. 14

Fig. 16

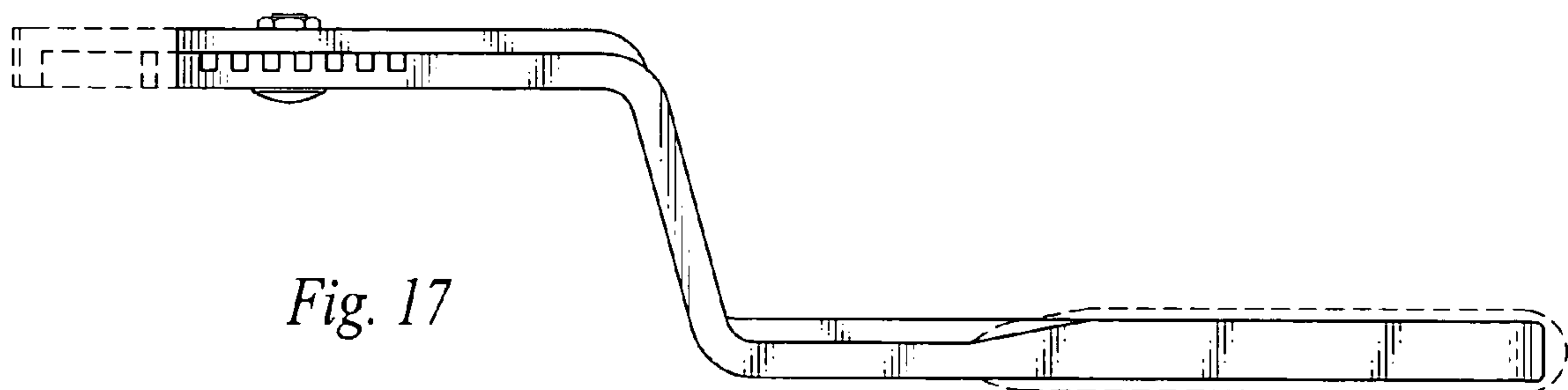

Fig. 17

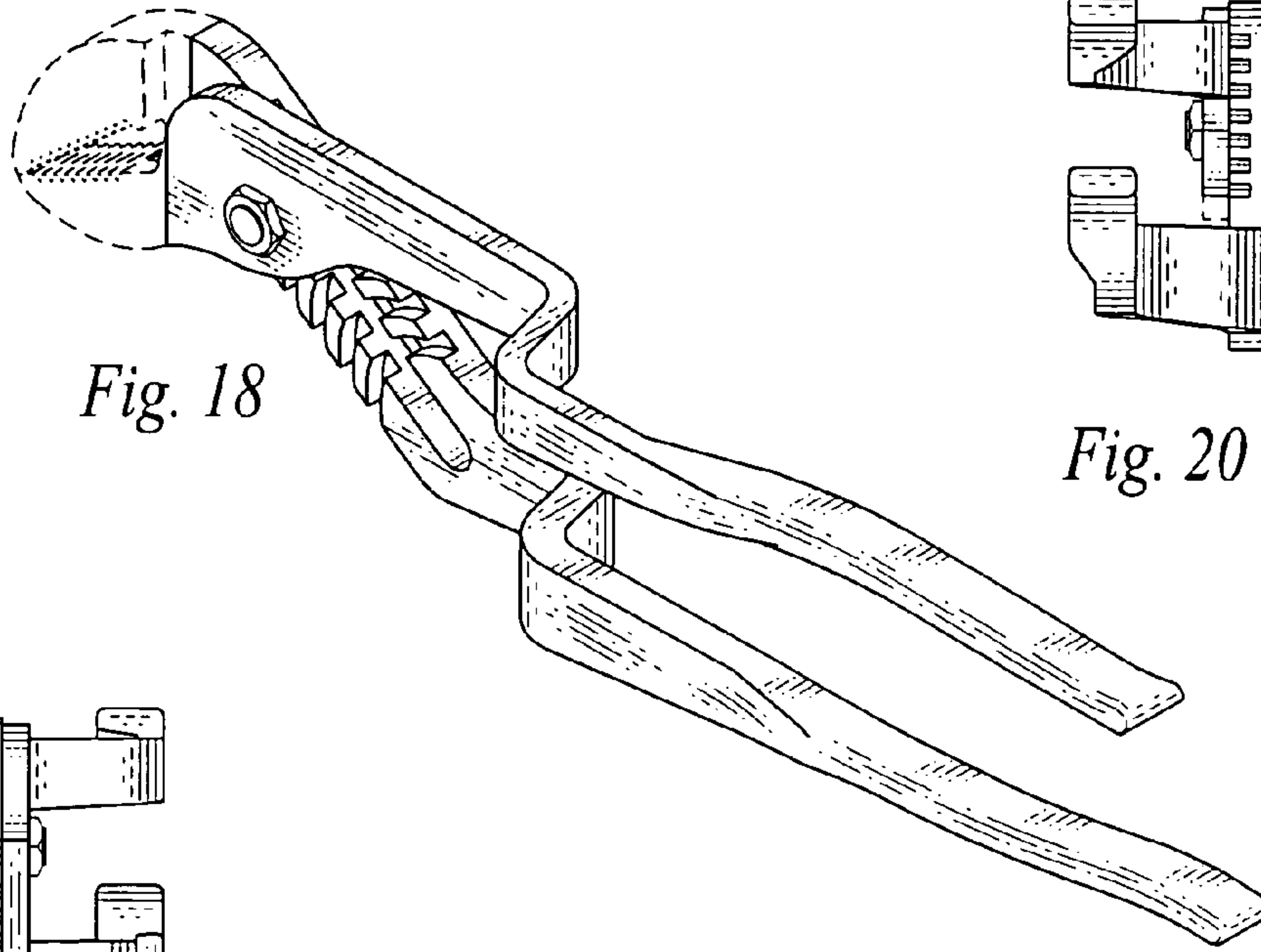

Fig. 18

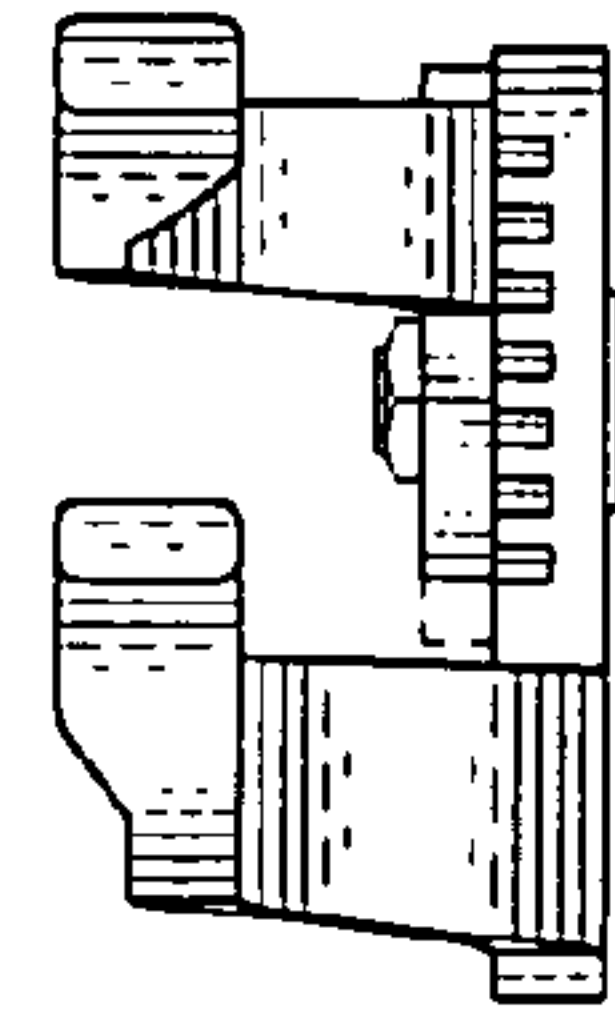

Fig. 20

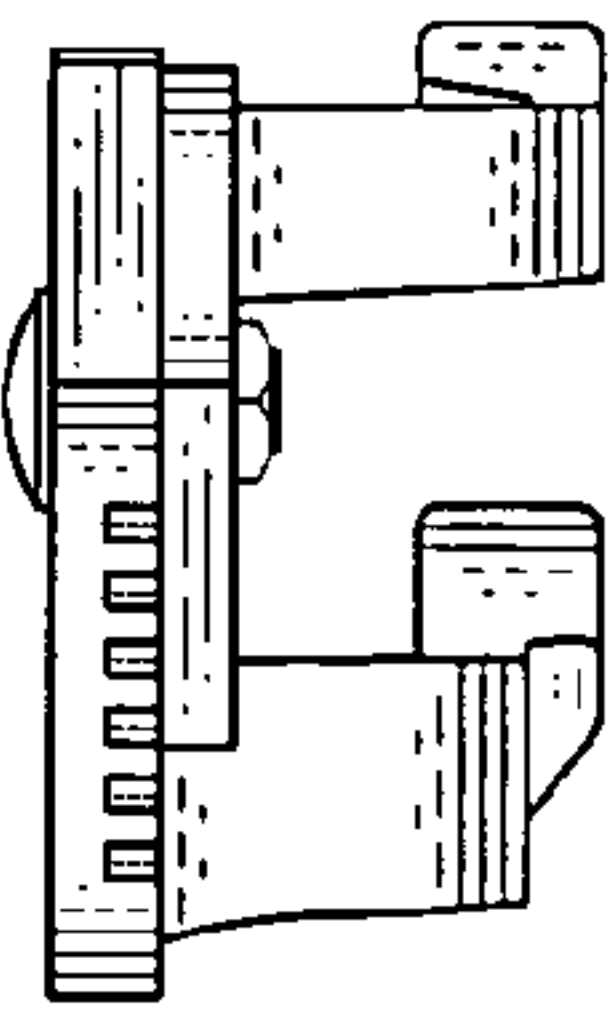

Fig. 19

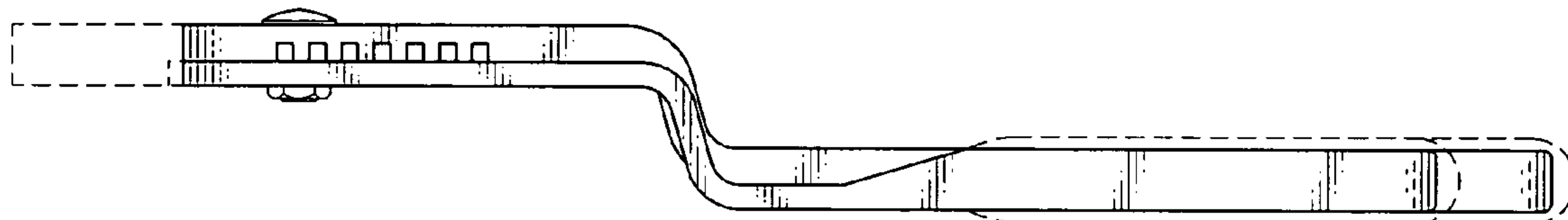

Fig. 21

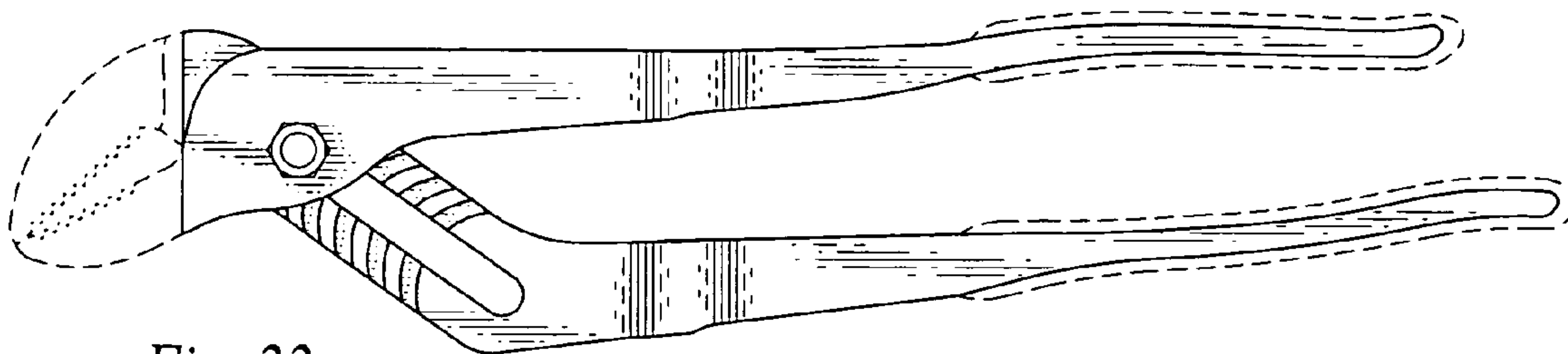

Fig. 22

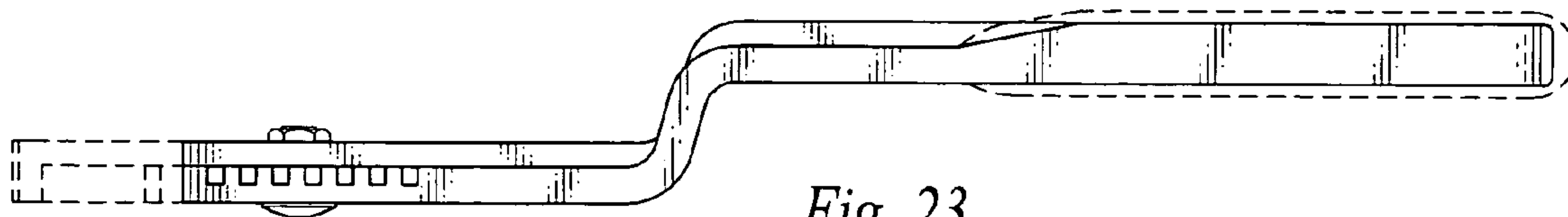

Fig. 23

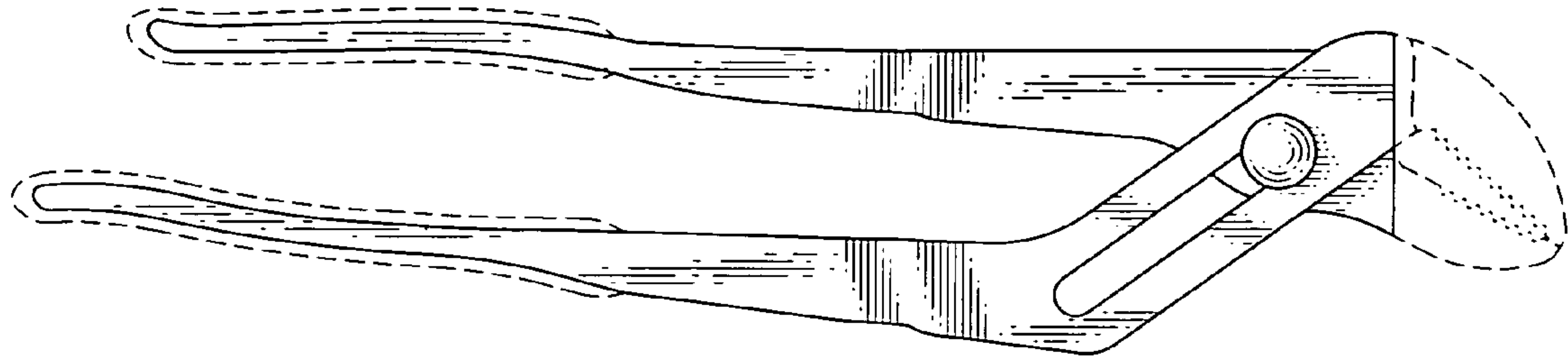

Fig. 24

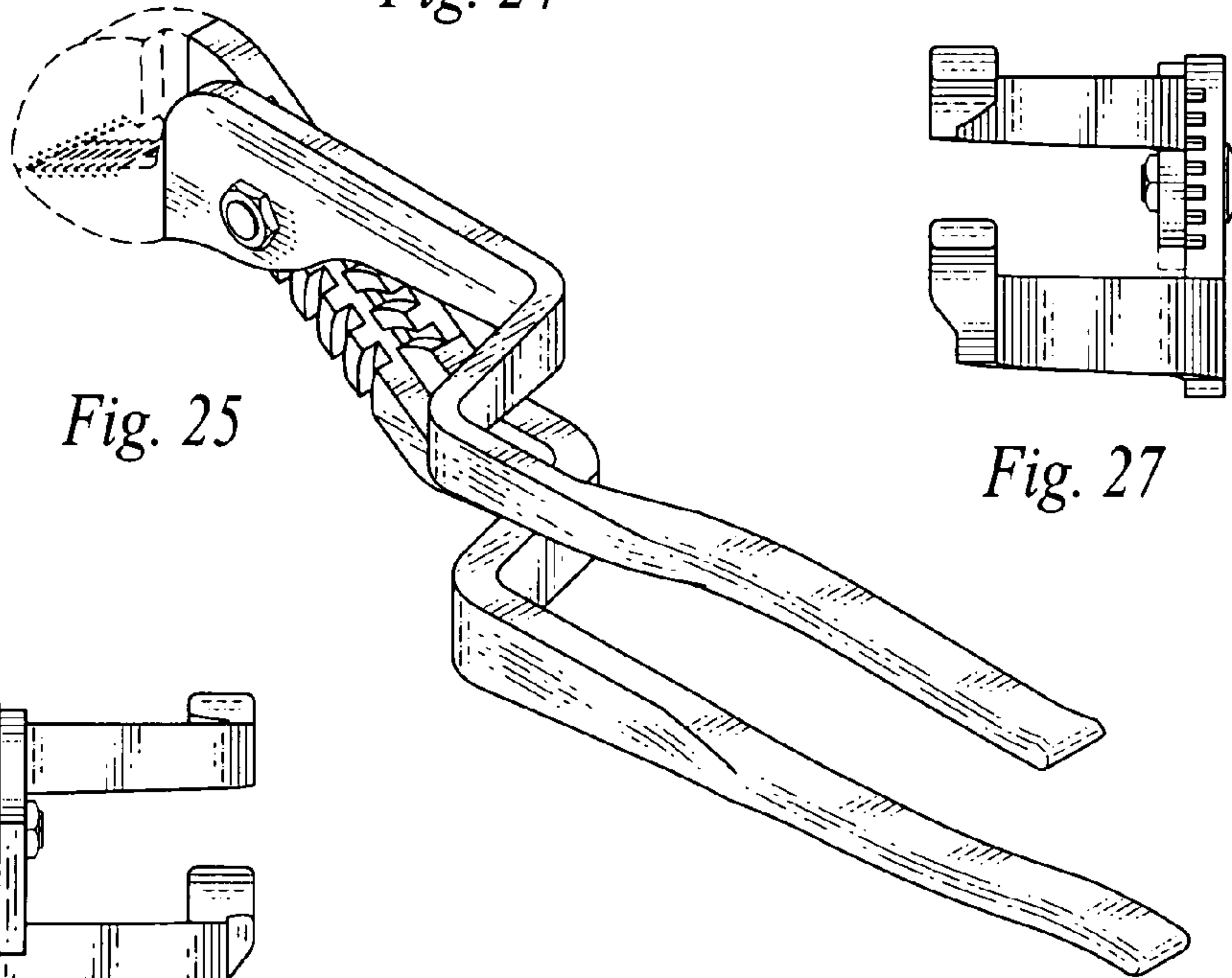

Fig. 25

Fig. 27

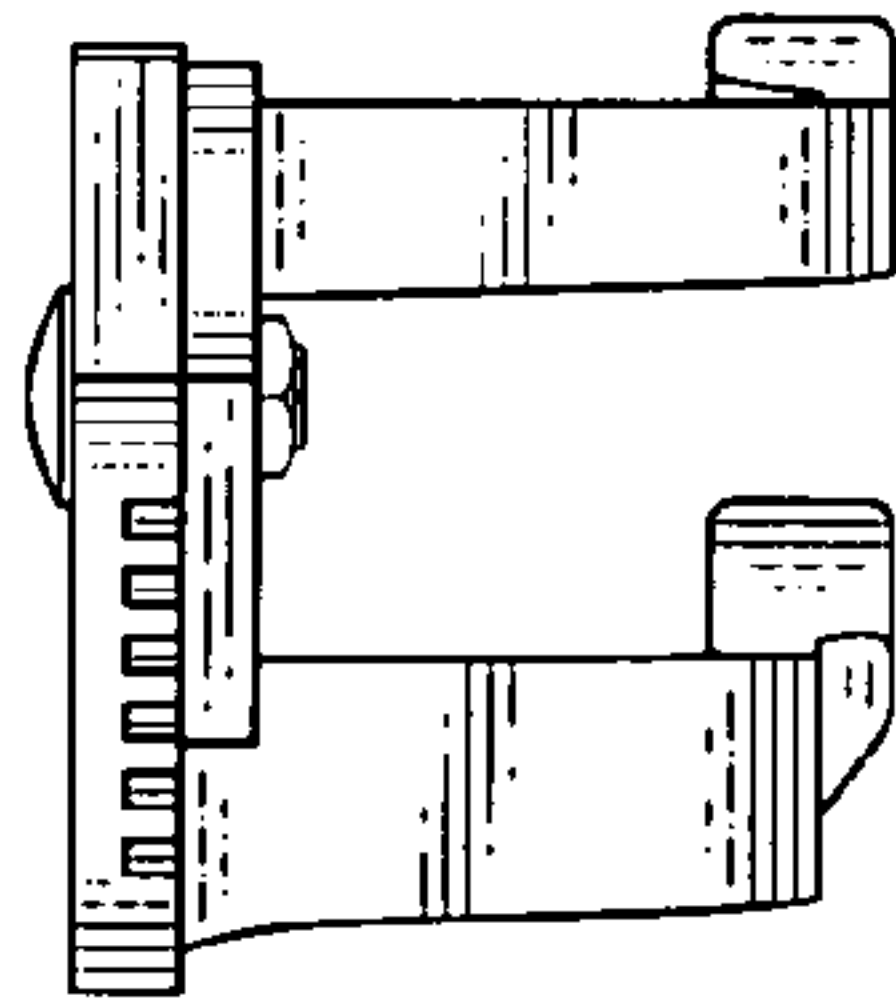

Fig. 26

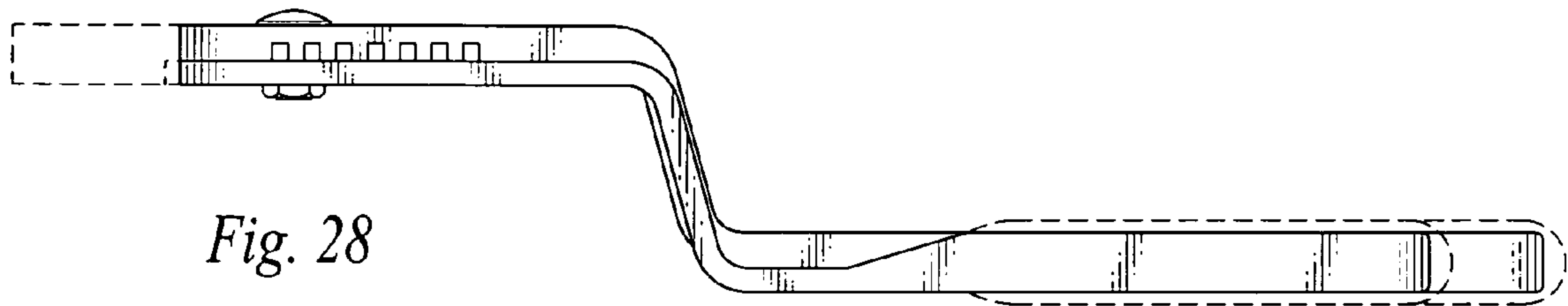

Fig. 28

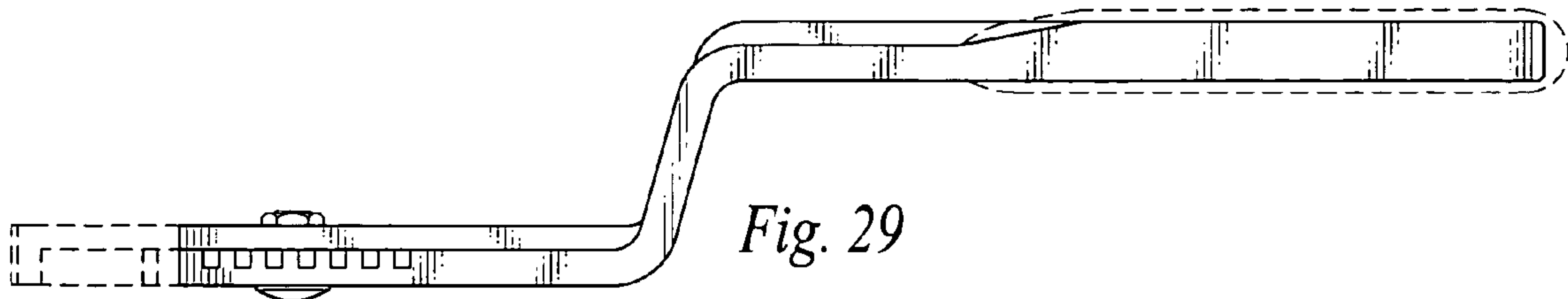

Fig. 29

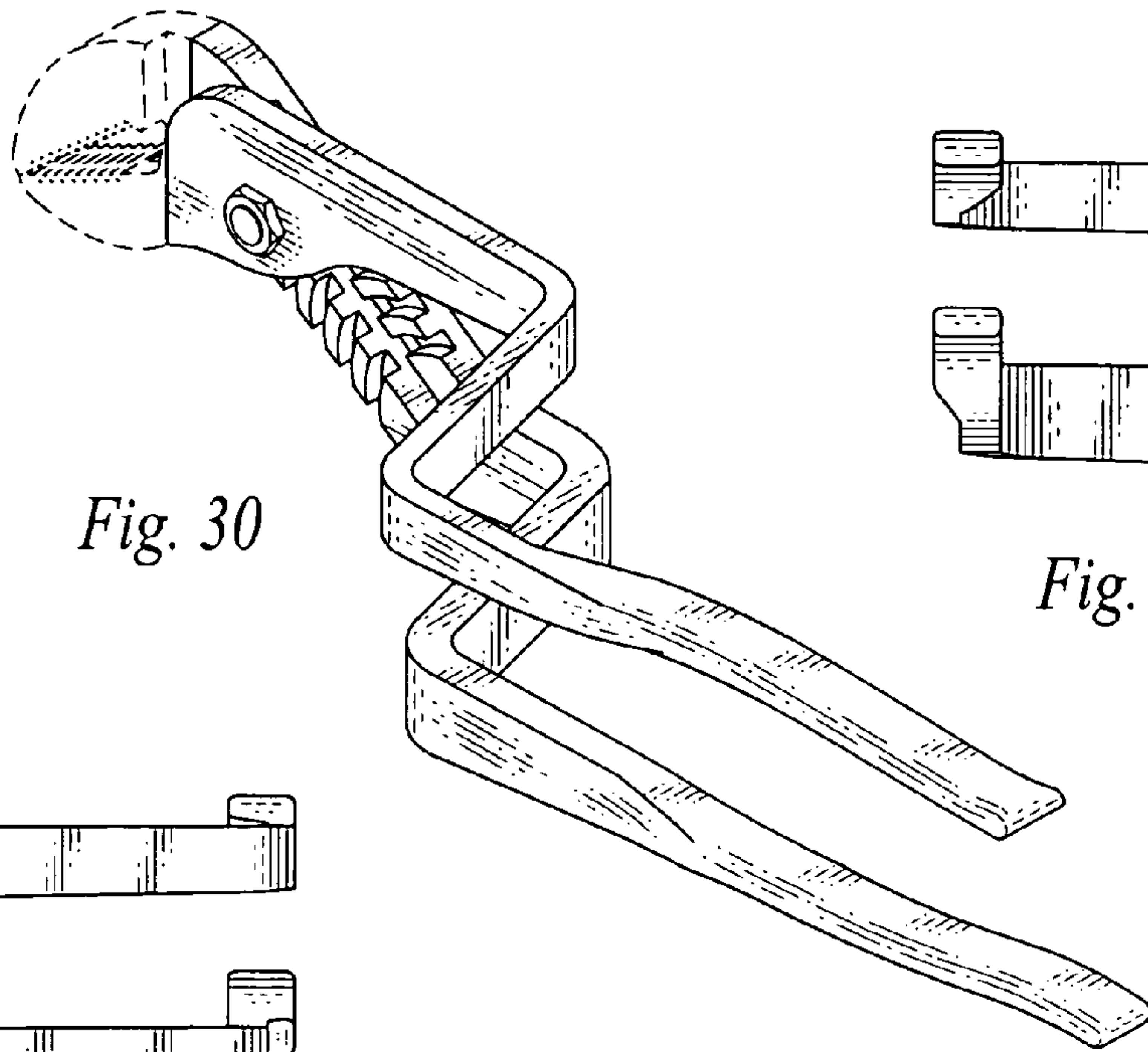

Fig. 30

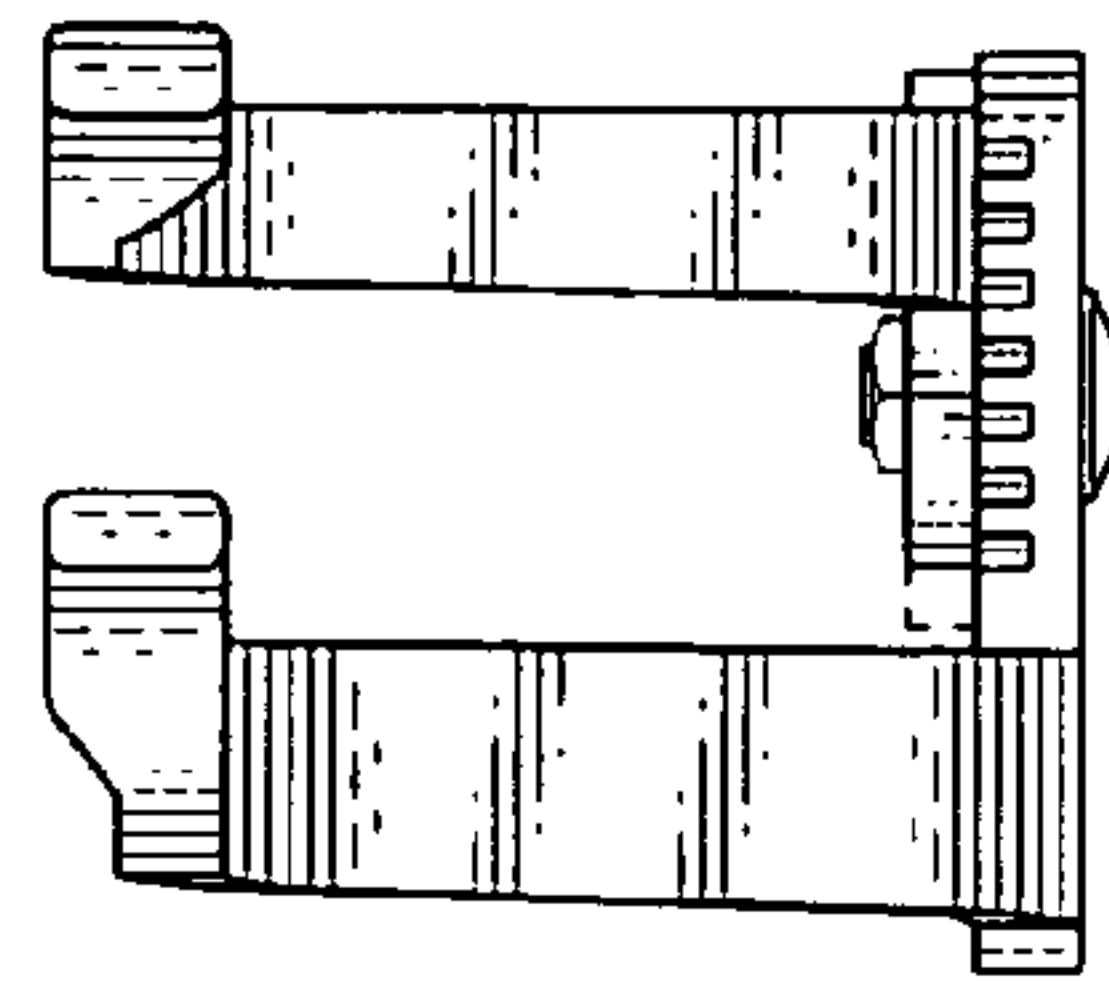

Fig. 32

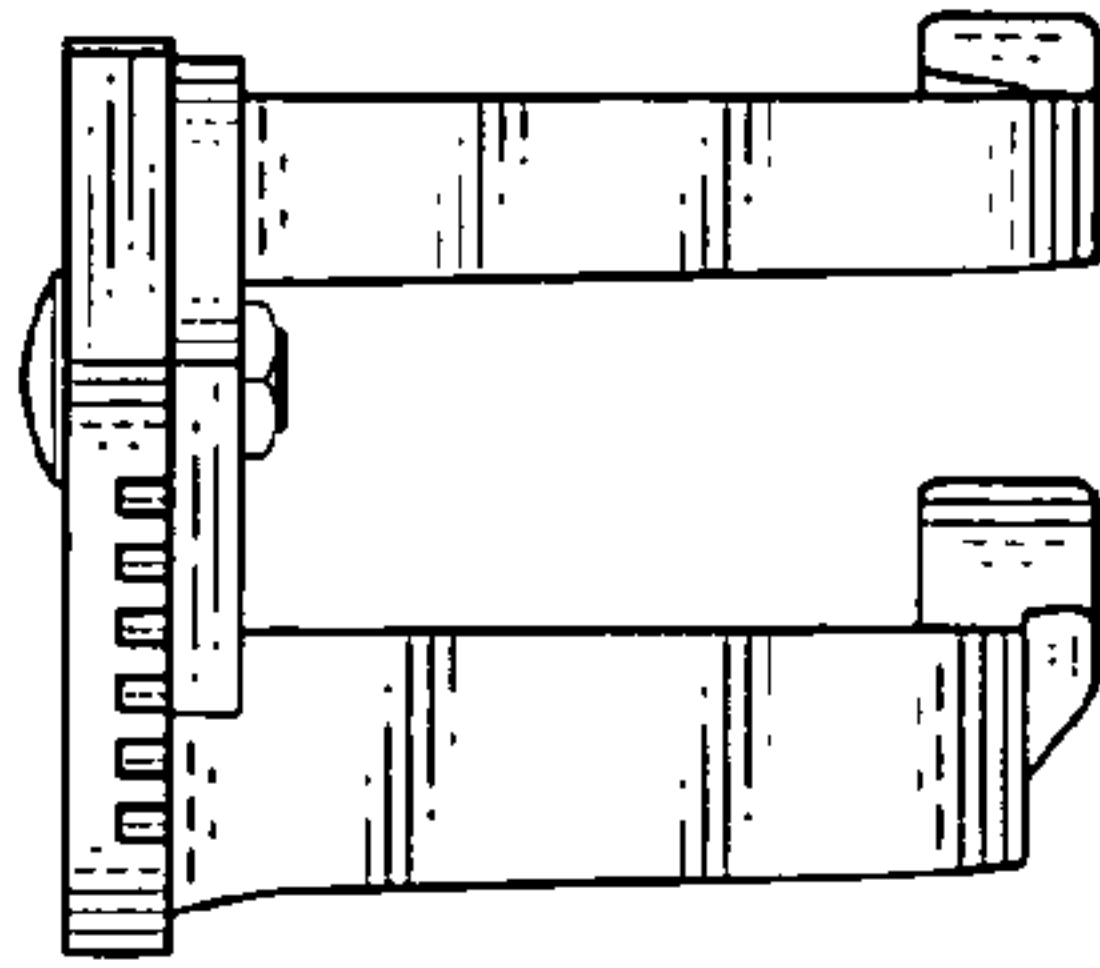

Fig. 31

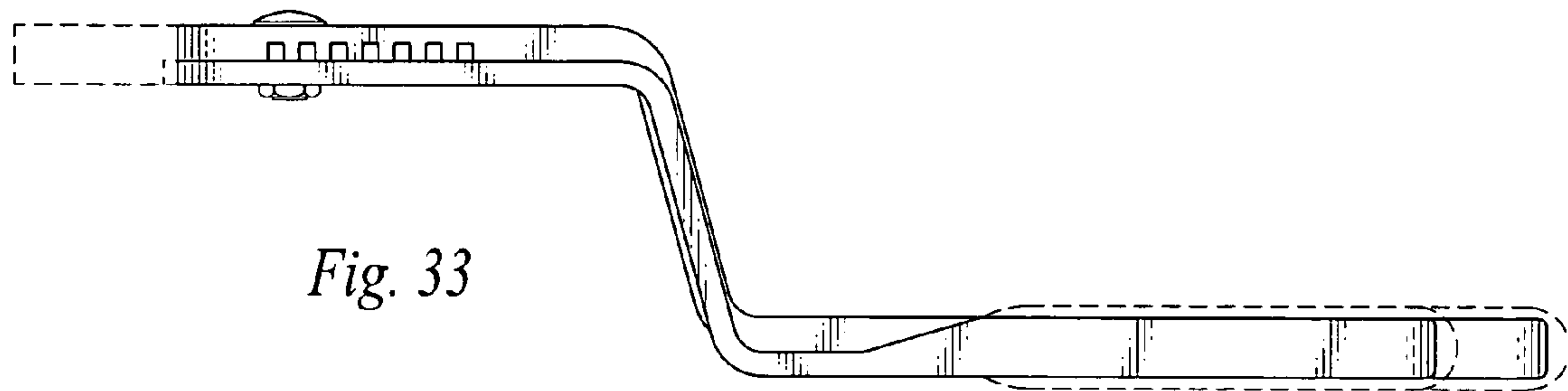

Fig. 33

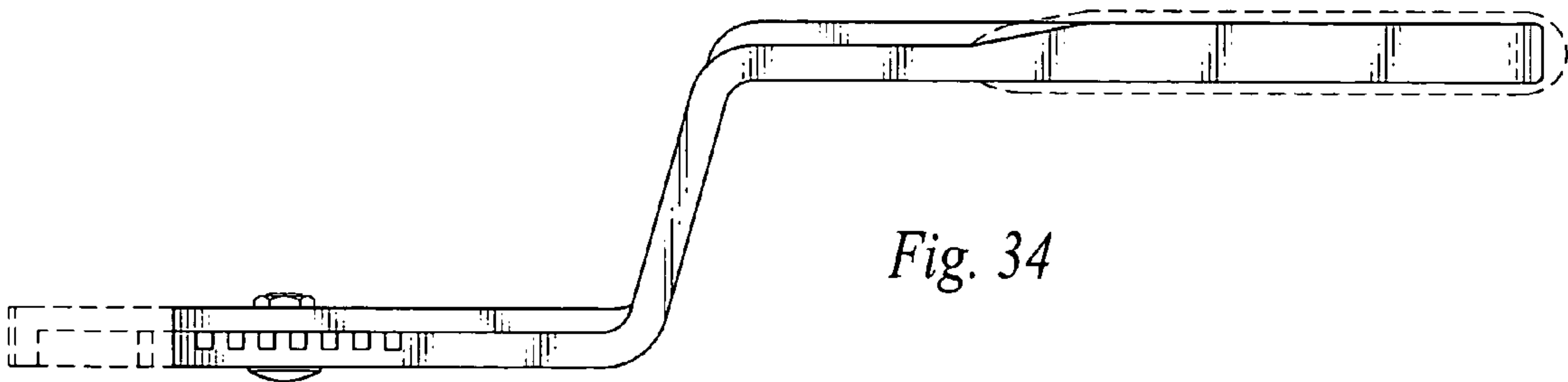

Fig. 34