



US00D607652S

(12) **United States Design Patent**  
**Karremans**

(10) **Patent No.:** **US D607,652 S**  
(45) **Date of Patent:** **\*\* Jan. 12, 2010**

(54) **INFANT CARRIER**

(75) Inventor: **Taco Karremans**, Eindhoven (NL)

(73) Assignee: **Cosco Management, Inc.**, Wilmington, DE (US)

(\*\*) Term: **14 Years**

(21) Appl. No.: **29/335,376**

(22) Filed: **Apr. 14, 2009**

(30) **Foreign Application Priority Data**

Oct. 15, 2008 (EM) ..... 001019871

(51) **LOC (9) Cl.** ..... **06-01**

(52) **U.S. Cl.** ..... **D6/333**

(58) **Field of Classification Search** ..... D6/333,  
D6/335, 339, 491, 500-502; 297/183.1,  
297/183.2, 183.3, 183.4, 184.13, 184.15,  
297/184.17, 250.1, 255, 256.1, 256.15, 256.16;  
5/94, 98.1, 99.1, 101, 102, 105, 655; 280/30,  
280/31; D21/412, 419; D12/129

See application file for complete search history.

(56) **References Cited**

**U.S. PATENT DOCUMENTS**

1,363,667 A \* 12/1920 Mahr ..... 5/94  
D232,137 S \* 7/1974 Peltier ..... D6/333  
4,997,231 A \* 3/1991 Smith ..... 297/184.13

D347,737 S \* 6/1994 Allard et al. .... D6/333  
5,522,639 A \* 6/1996 Jaime ..... 297/184.13  
D429,075 S \* 8/2000 Cone, II ..... D6/333  
D431,116 S \* 9/2000 Gibson et al. .... D6/333  
D438,731 S \* 3/2001 Brown et al. .... D6/491  
D589,268 S \* 3/2009 Jane Stopp ..... D6/333

\* cited by examiner

*Primary Examiner*—Sandra Snapp

(74) *Attorney, Agent, or Firm*—Barnes & Thornburg LLP

(57) **CLAIM**

The ornamental design for an infant carrier, as shown and described.

**DESCRIPTION**

FIG. 1 is a perspective view, taken from the front, right side, of the infant carrier according to my design;

FIG. 2 is a front view thereof;

FIG. 3 is a rear view thereof;

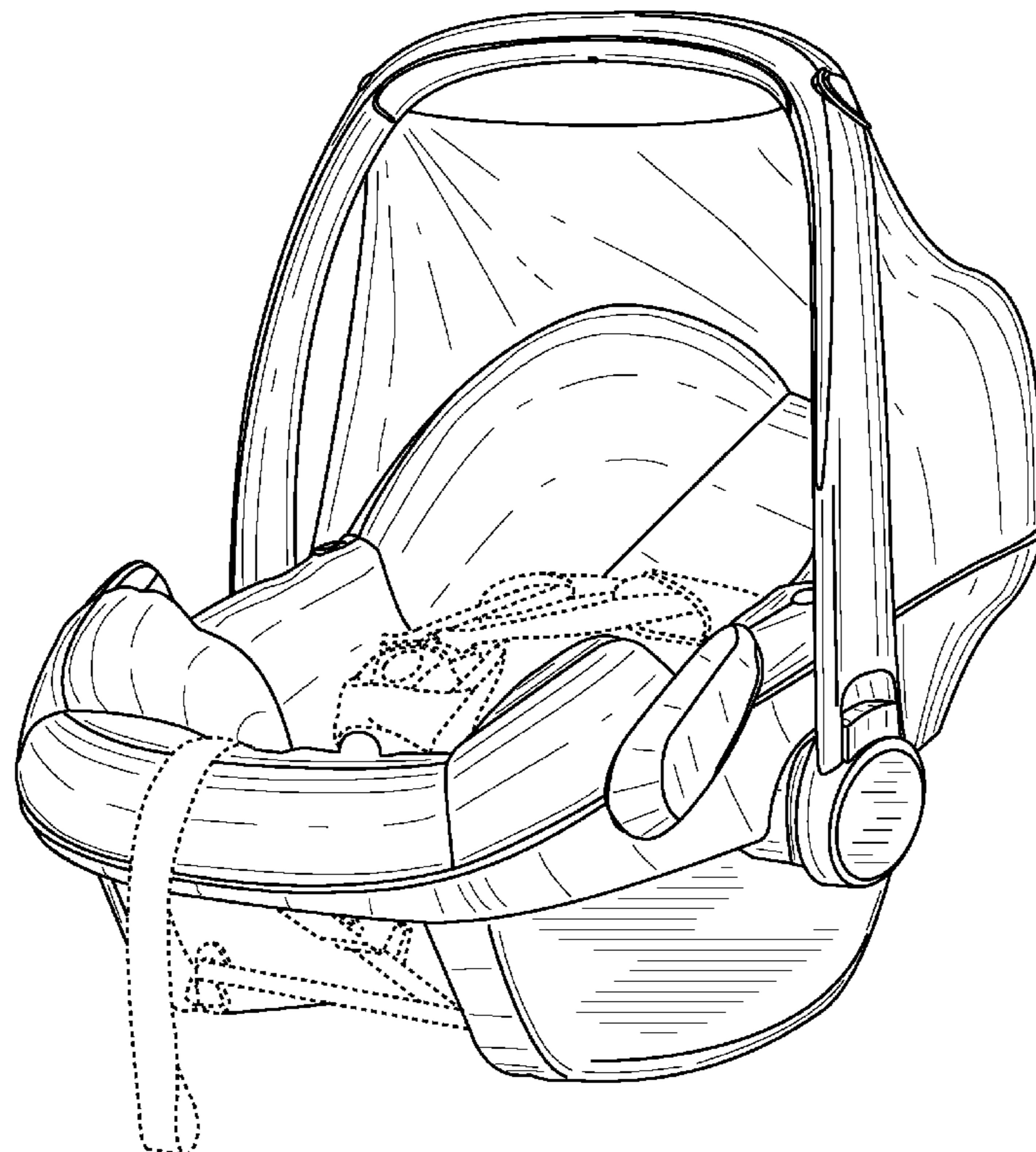
FIG. 4 is left side view thereof, the right side view being a mirror image thereof;

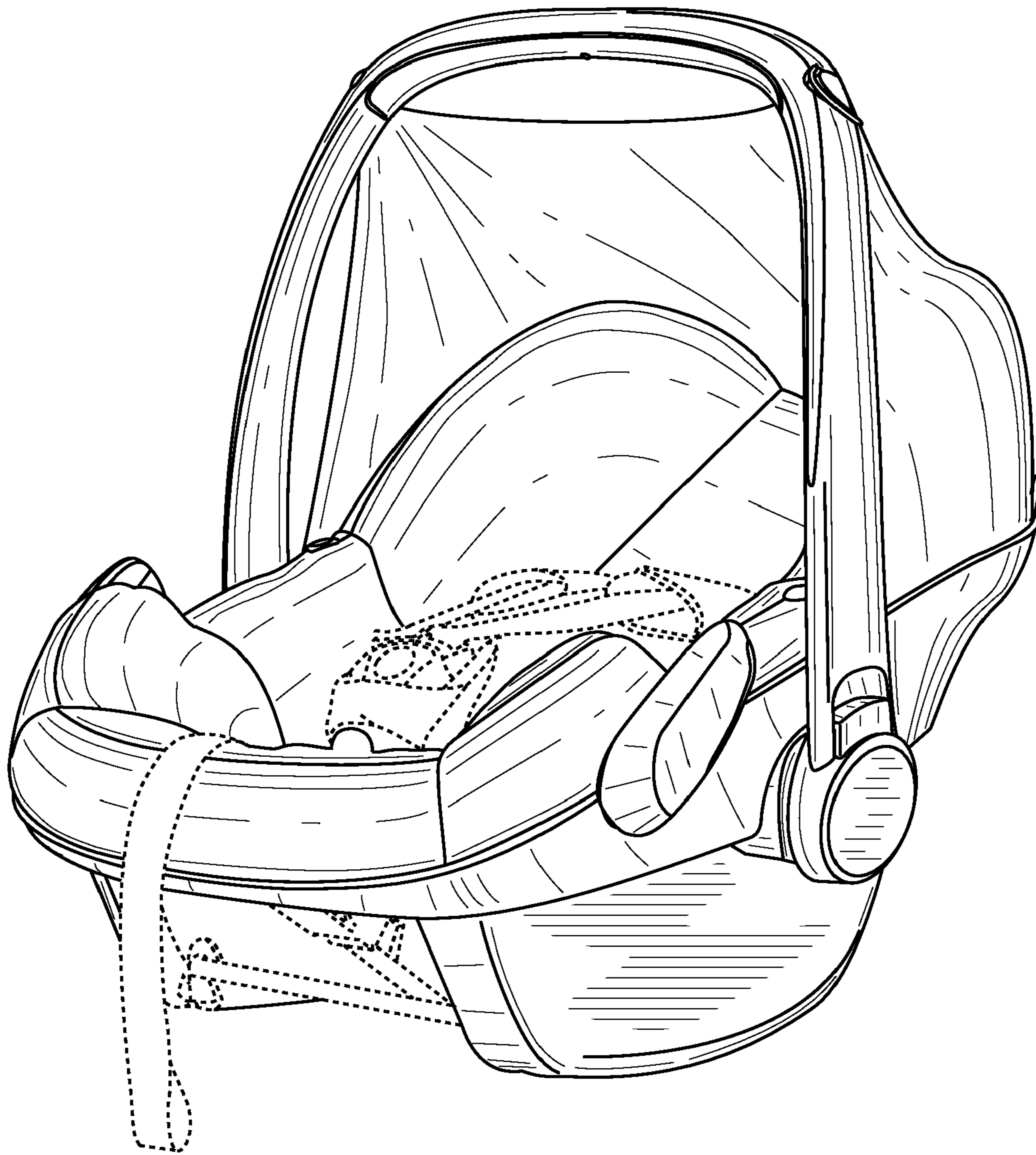
FIG. 5 is a top view thereof; and,

FIG. 6 is a bottom view thereof.

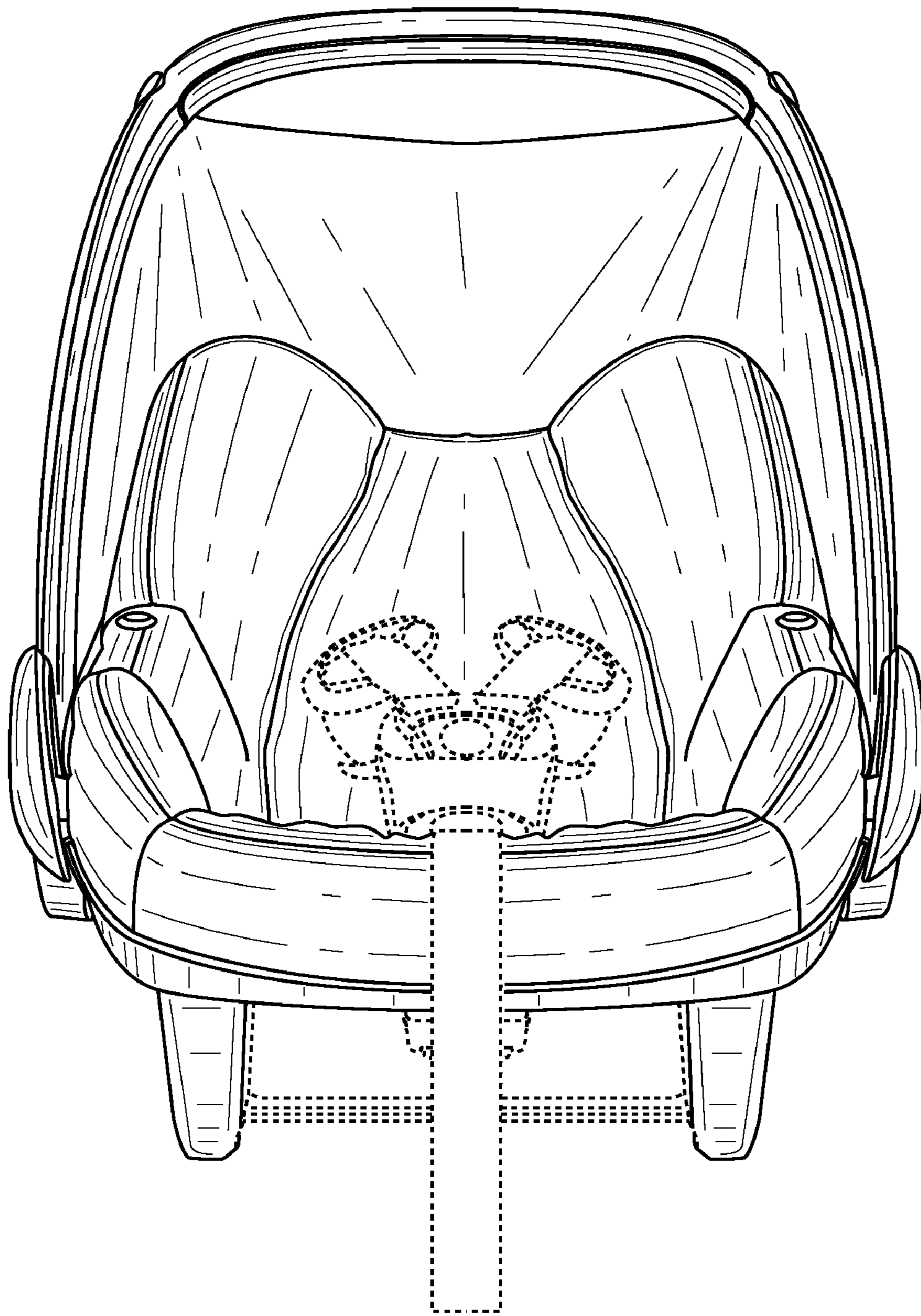
The broken lines for various components illustrated in FIGS. 1-2 and 4-6 are for illustrative purposes only and form no part of the claimed design.

**1 Claim, 6 Drawing Sheets**

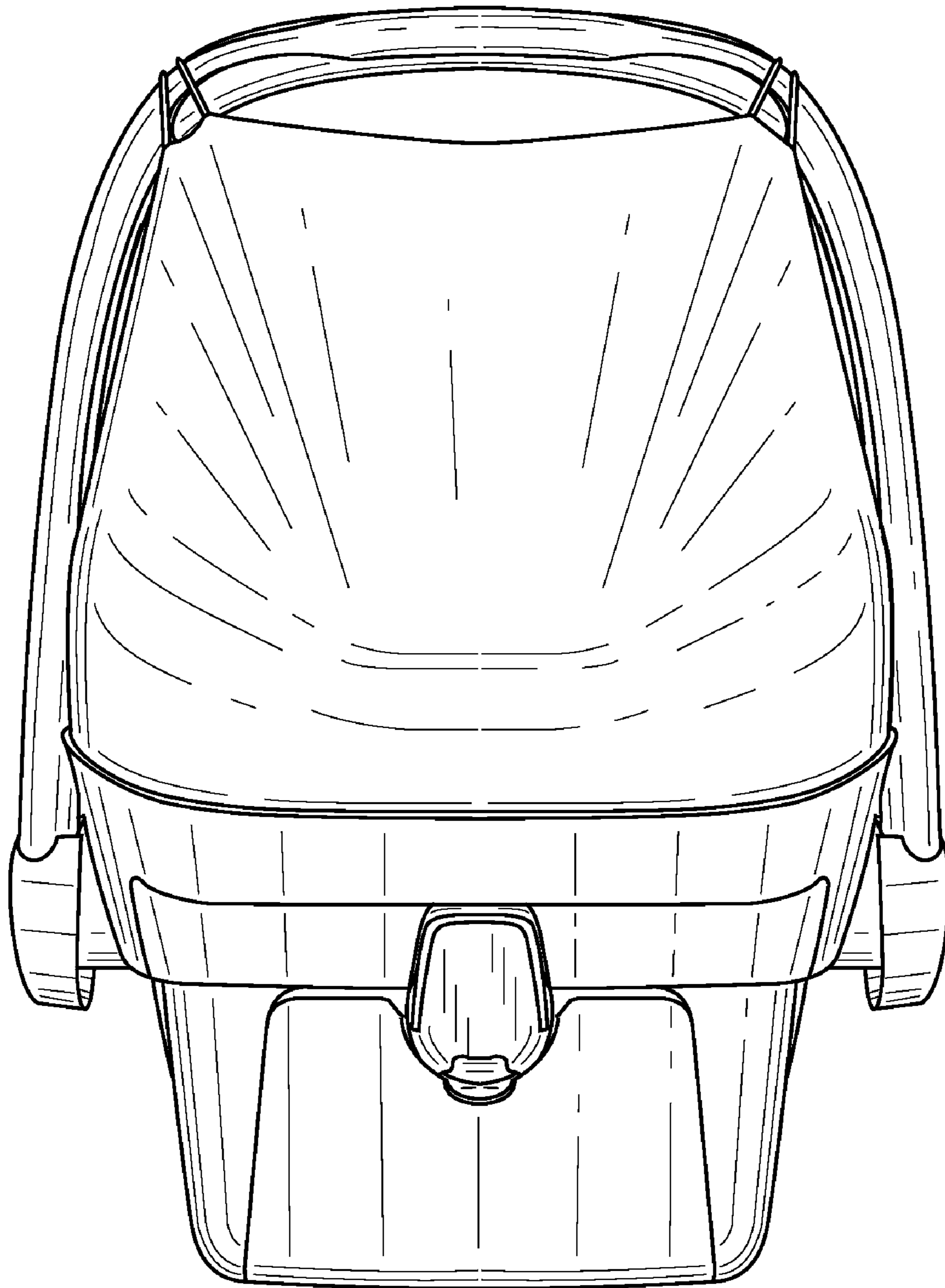




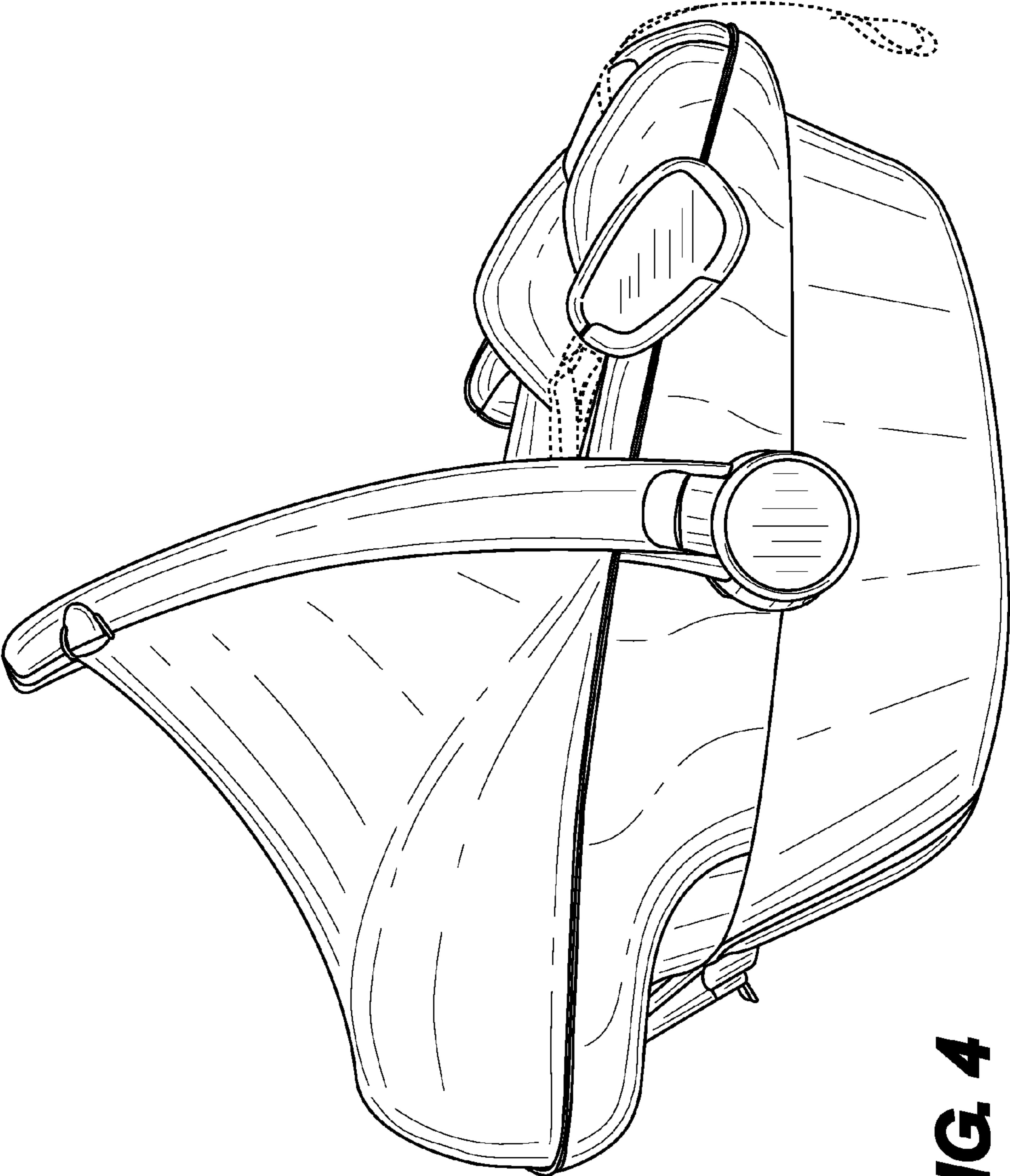
**FIG. 1**



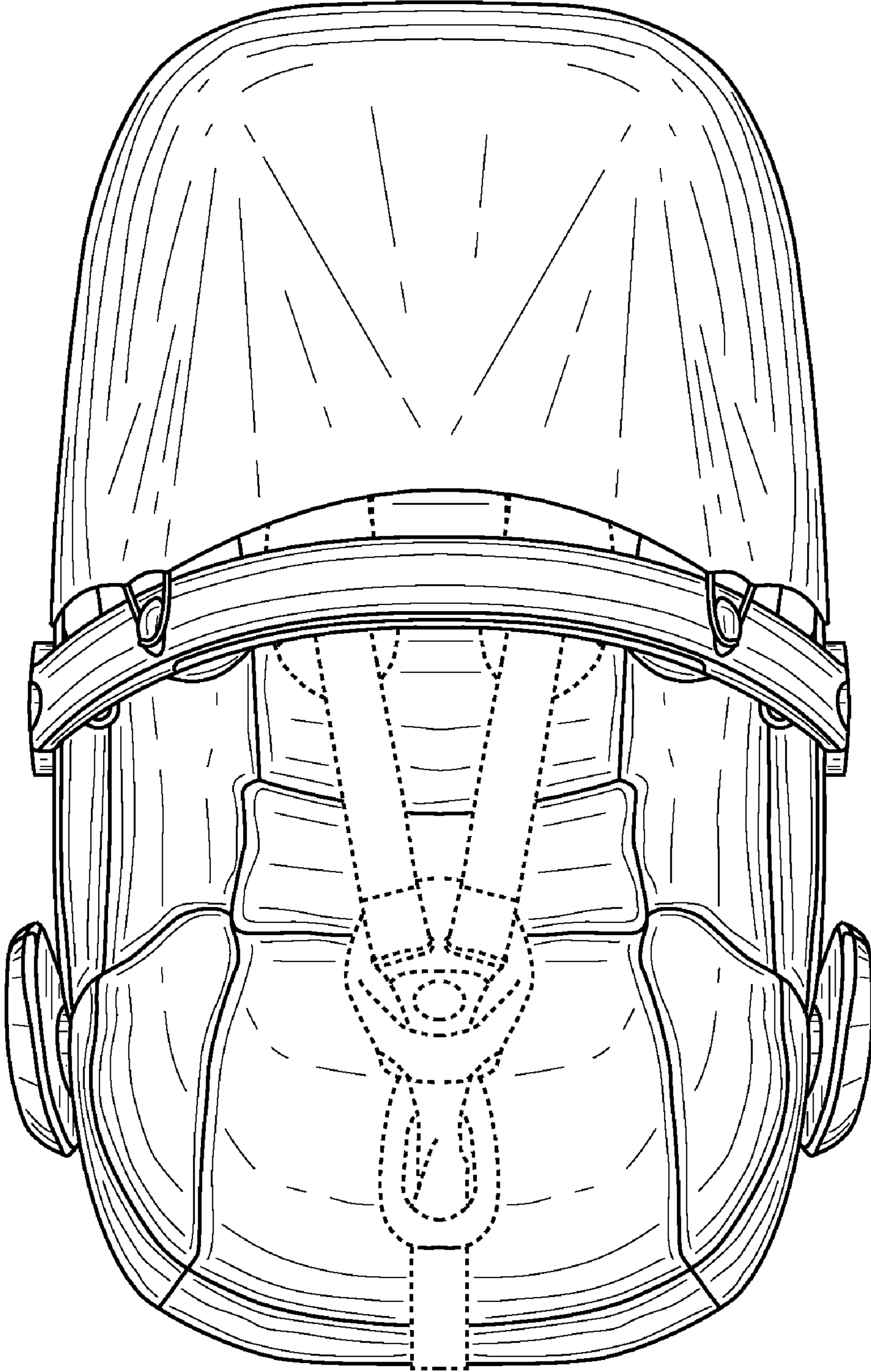
**FIG. 2**



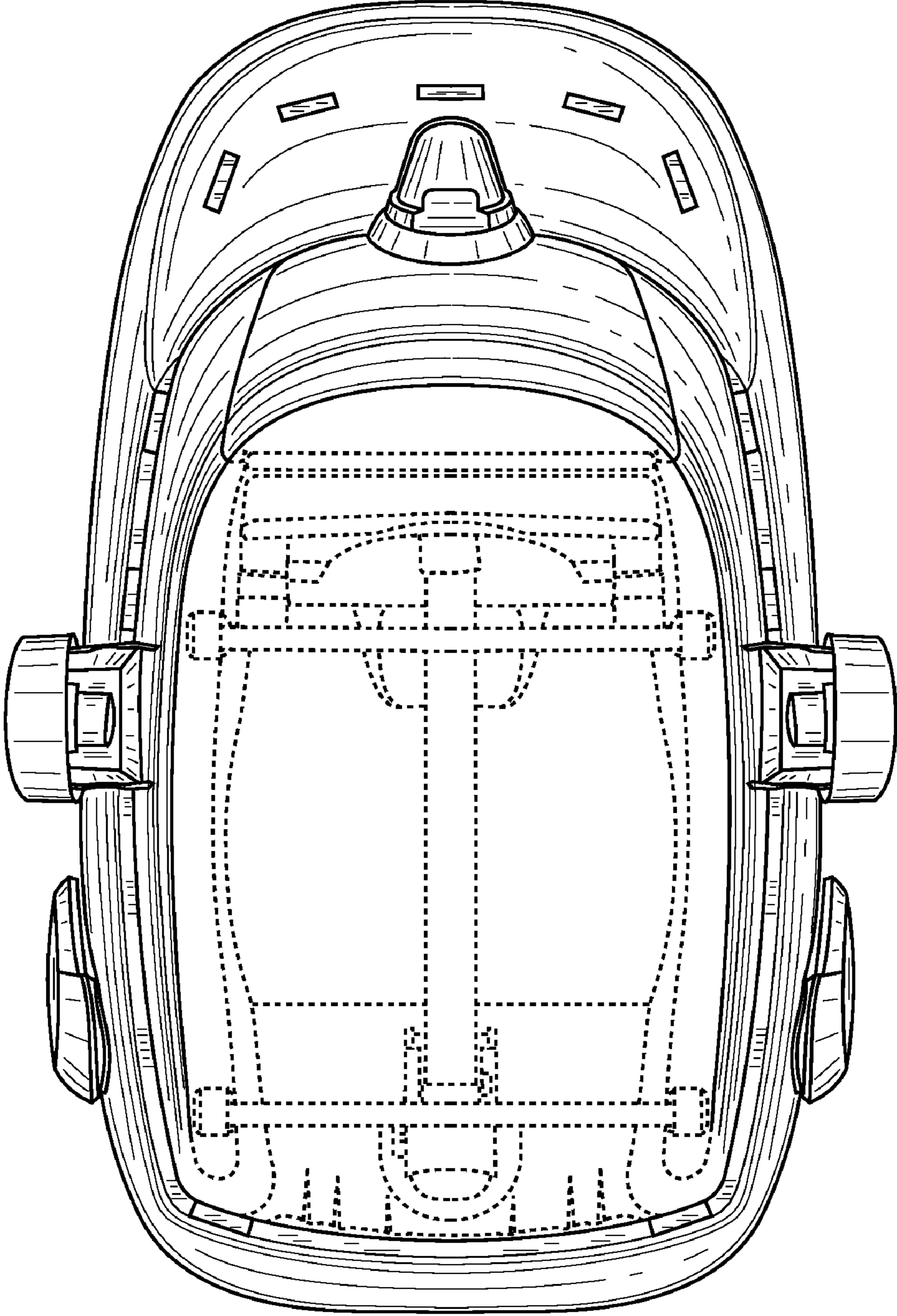
**FIG. 3**



**FIG. 4**



**FIG. 5**



**FIG. 6**