



US00D607651S

(12) **United States Design Patent**
Karremans

(10) **Patent No.:** **US D607,651 S**
(45) **Date of Patent:** **** Jan. 12, 2010**

(54) **INFANT CARRIER**

(75) Inventor: **Taco Karremans**, Eindhoven (NL)

(73) Assignee: **Cosco Management, Inc.**, Wilmington, DE (US)

(**) Term: **14 Years**

(21) Appl. No.: **29/335,373**

(22) Filed: **Apr. 14, 2009**

(30) **Foreign Application Priority Data**

Oct. 15, 2008 (EM) 001019871

(51) **LOC (9) Cl.** **06-01**

(52) **U.S. Cl.** **D6/333**

(58) **Field of Classification Search** D6/333,
D6/335, 339, 491, 500-502; 297/183.1,
297/183.2, 183.3, 183.4, 184.13, 184.15,
297/184.17, 250.1, 255, 256.1, 256.15, 256.16;
5/94, 98.1, 99.1, 101, 102, 105, 655; 280/30,
280/31; D21/412, 419; D12/129
See application file for complete search history.

(56) **References Cited**

U.S. PATENT DOCUMENTS

4,943,113	A *	7/1990	Meeker	297/256.16
4,958,887	A *	9/1990	Meeker	297/256.17
5,322,343	A *	6/1994	Parker et al.	297/183.3
D373,028	S *	8/1996	Kain	D6/333
D374,558	S *	10/1996	Kain	D6/333
5,727,798	A *	3/1998	Walters et al.	280/30
D402,124	S *	12/1998	Haut et al.	D6/333

D402,477	S *	12/1998	Cone, II	D6/333
D429,075	S *	8/2000	Cone, II	D6/333
D545,074	S *	6/2007	Loew et al.	D6/356
D555,402	S *	11/2007	Hou et al.	D6/500
D558,467	S *	1/2008	Hou et al.	D6/333
D572,027	S *	7/2008	Hui	D6/333
2004/0207241	A1 *	10/2004	Sedlack	297/250.1
2004/0212232	A1 *	10/2004	Sedlack	297/250.1
2005/0168023	A1 *	8/2005	Gangadharan et al.	...	297/250.1
2005/0189797	A1 *	9/2005	Robertson	297/183.3
2005/0264062	A1 *	12/2005	Longenecker et al.	297/250.1

* cited by examiner

Primary Examiner—Sandra Snapp

(74) *Attorney, Agent, or Firm*—Barnes & Thornburg LLP

(57) **CLAIM**

The ornamental design for an infant carrier, as shown and described.

DESCRIPTION

FIG. 1 is a perspective view, taken from the front, right side, of the infant carrier according to my design;

FIG. 2 is a front view thereof;

FIG. 3 is rear view thereof;

FIG. 4 is a left side view thereof, the right side view being a mirror image thereof;

FIG. 5 is a top view thereof; and,

FIG. 6 is a bottom view thereof.

The broken lines for various components illustrated in FIGS. 1-2 and 4-6 are for illustrative purposes only and form no part of the claimed design.

1 Claim, 6 Drawing Sheets

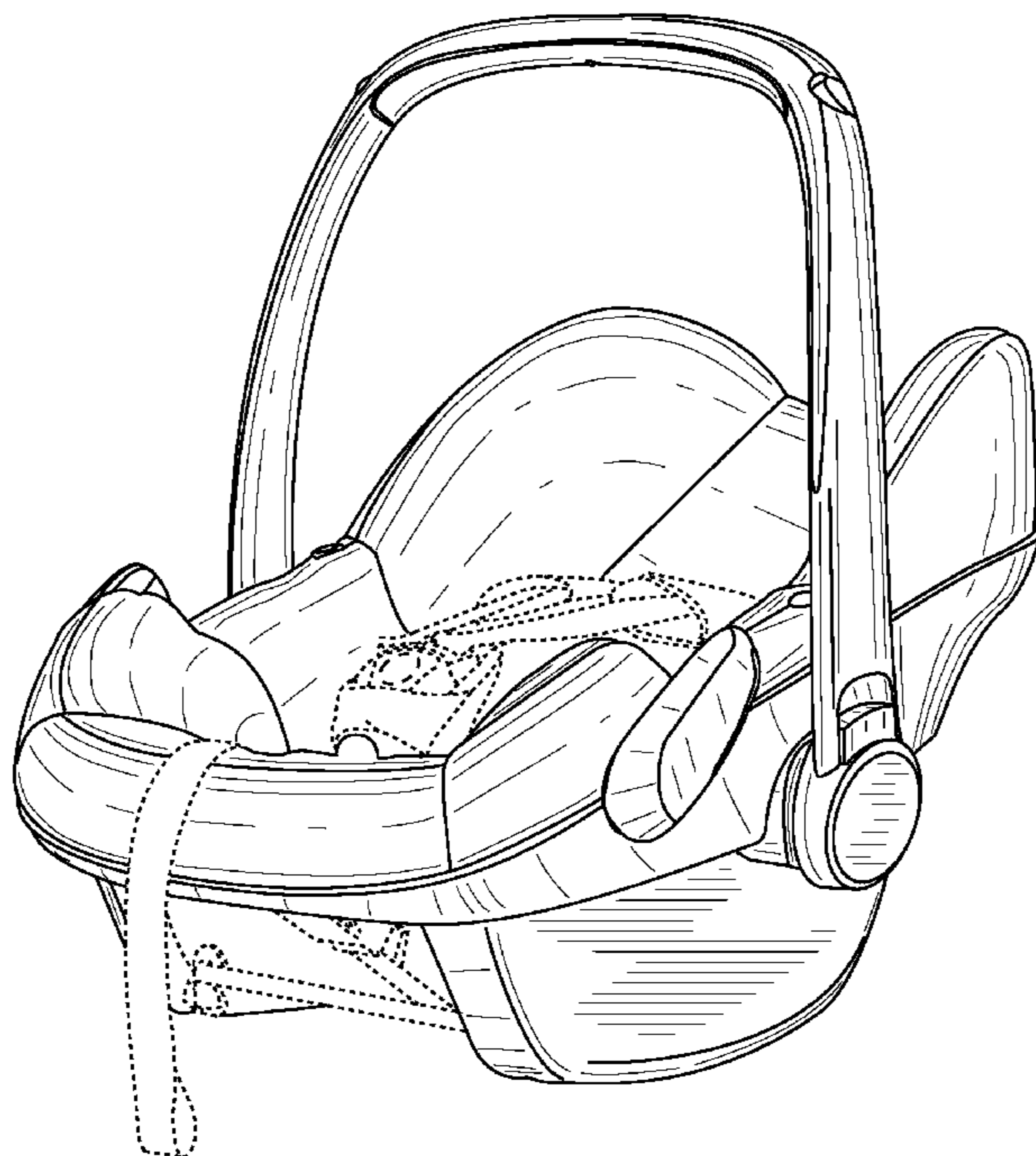

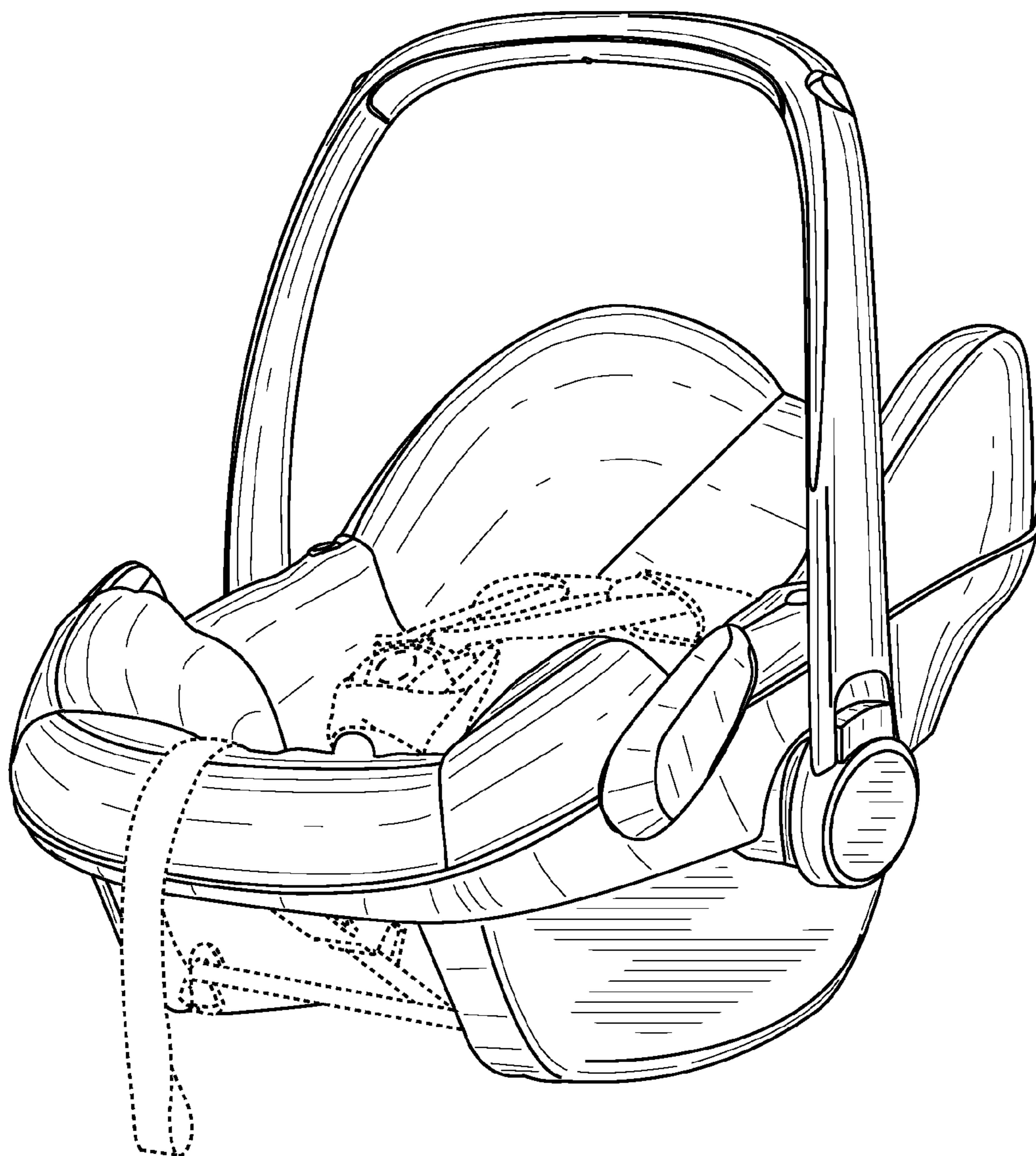

FIG. 1

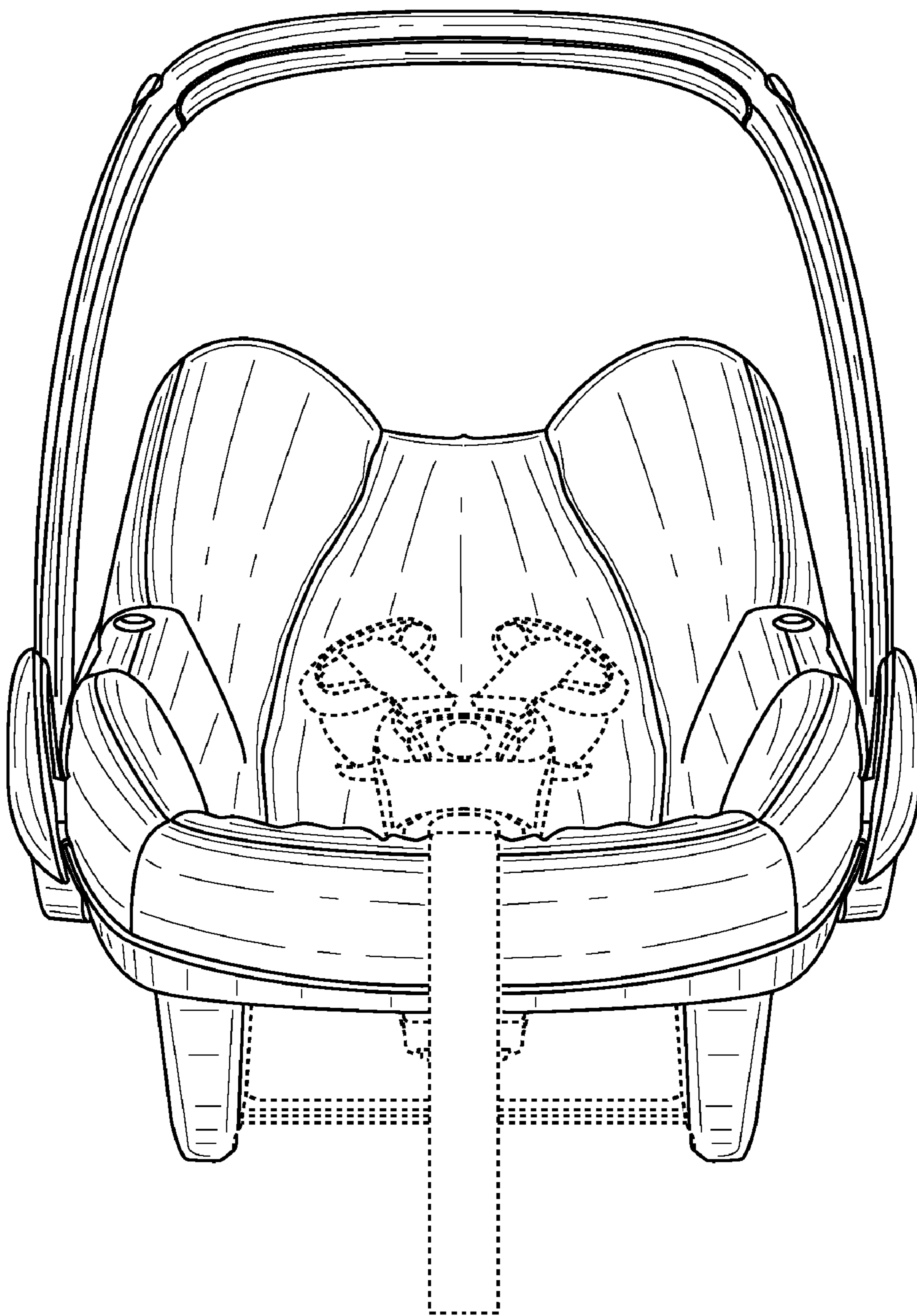

FIG. 2

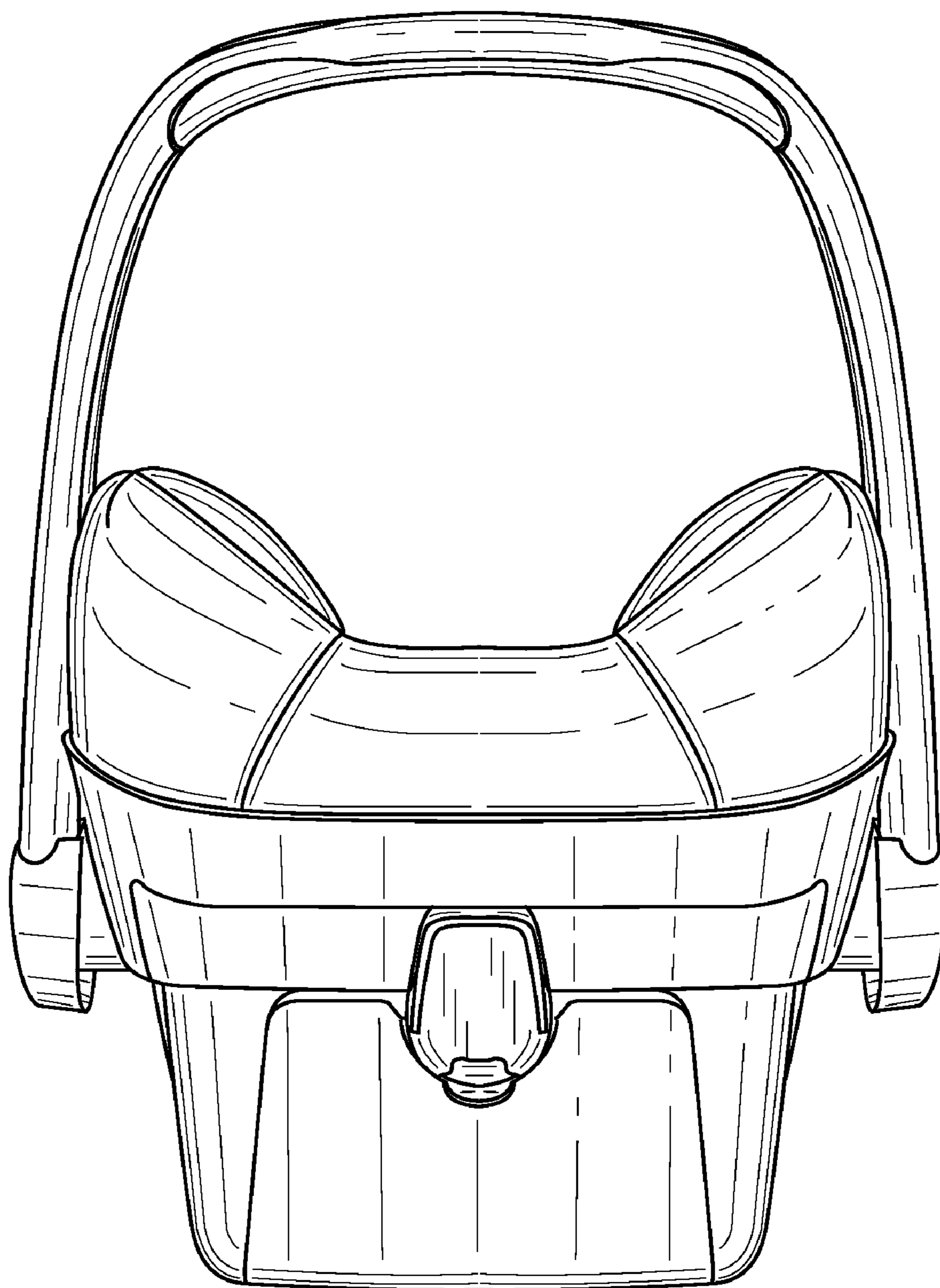

FIG. 3

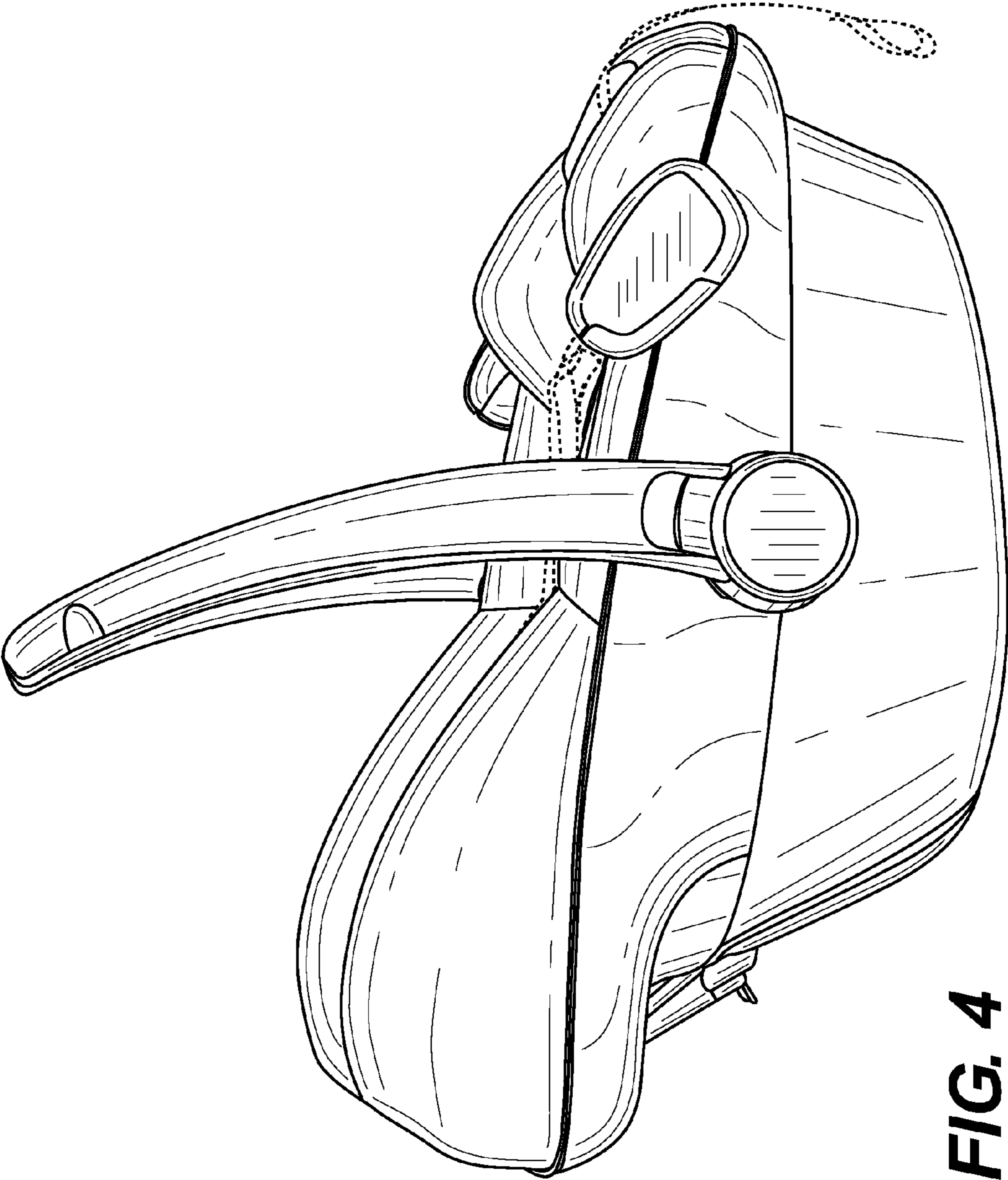

FIG. 4

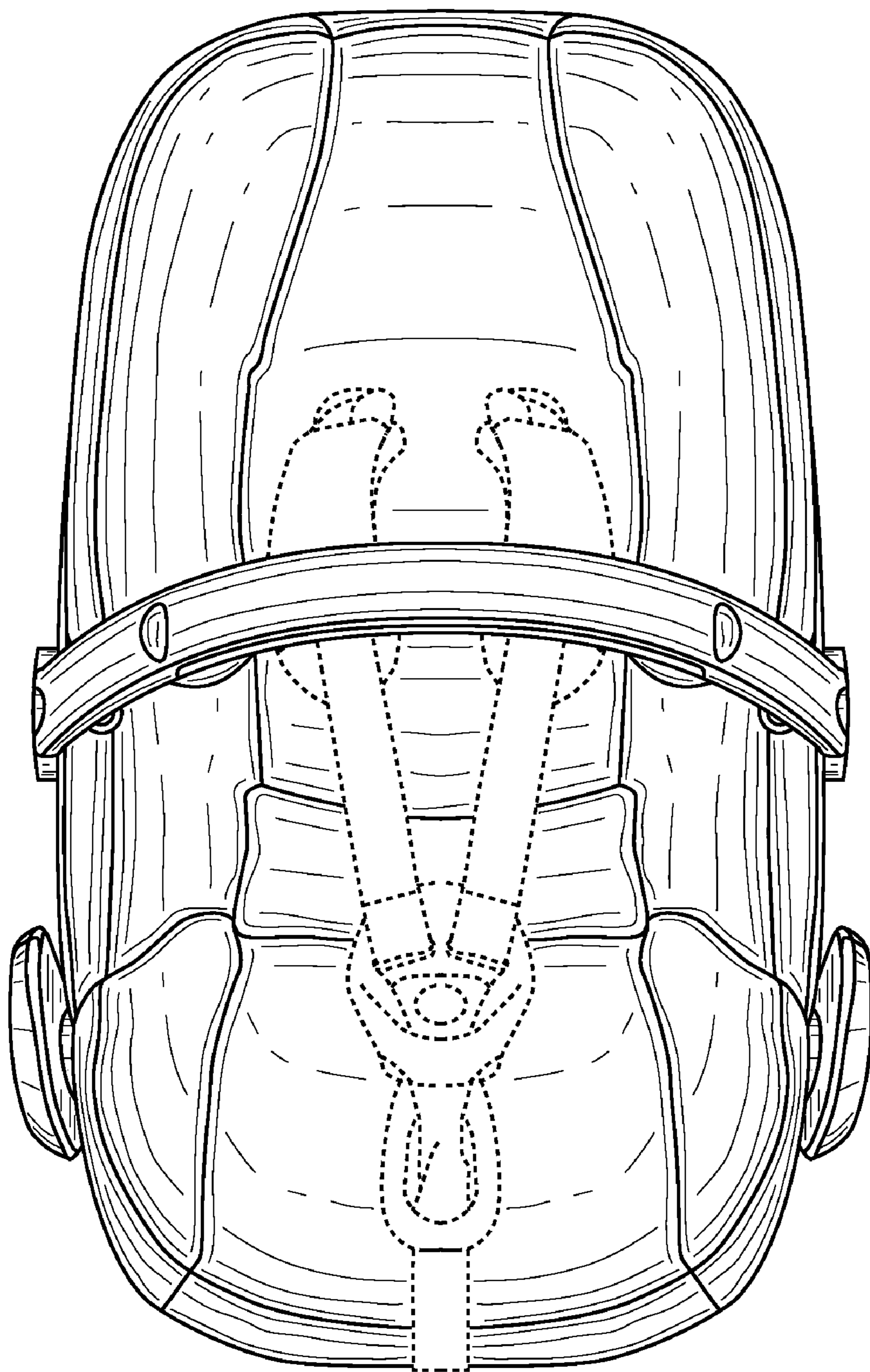

FIG. 5

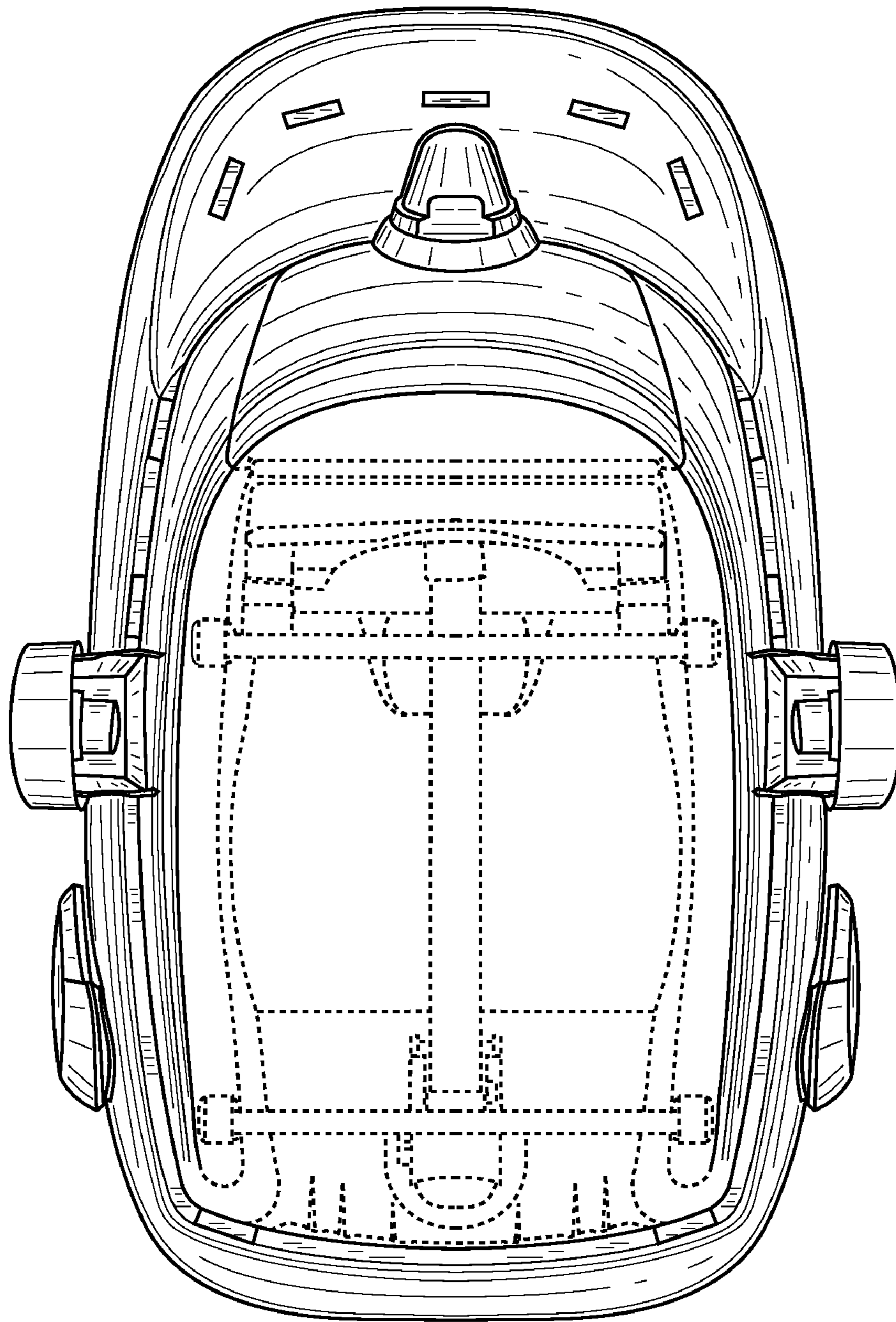

FIG. 6