



US00D607541S

(12) **United States Design Patent**
German et al.

(10) **Patent No.:** **US D607,541 S**
(45) **Date of Patent:** **** Jan. 5, 2010**

(54) **FLAPPER DISC**

(75) Inventors: **Mikhail German**, Johnston, RI (US);
Leo W. Fleury, North Smithfield, RI
(US); **Ken Clark**, Oreana, IL (US)

(73) Assignee: **Mueller International, Inc.**,
Portsmouth, NH (US)

(**) Term: **14 Years**

(21) Appl. No.: **29/280,982**

(22) Filed: **Jun. 12, 2007**

(51) **LOC (9) Cl.** **23-01**

(52) **U.S. Cl.** **D23/249**

(58) **Field of Classification Search** D23/254,
D23/249, 213, 258, 236, 233; D10/106;
700/85, 83; 345/156; 138/46; 340/407.2;
D13/168, 164; 137/299, 300, 138, 218

See application file for complete search history.

(56) **References Cited**

U.S. PATENT DOCUMENTS

2,083,319	A	6/1937	Daviet	
2,378,613	A	6/1945	Young et al.	
2,741,775	A	4/1956	Schmidt	
3,541,945	A	11/1970	Wexler	
3,566,905	A	3/1971	Noland	
3,814,542	A	6/1974	Iglesias et al.	
D246,958	S *	1/1978	Rakocy et al.	D10/106
D268,048	S *	2/1983	Ueda	D23/248
4,390,038	A	6/1983	Salvato	
4,393,891	A	7/1983	Snoek et al.	
4,475,570	A	10/1984	Pike et al.	
4,499,616	A	2/1985	Johnson	
D281,713	S	12/1985	Mikol	
D290,640	S *	6/1987	Andersson	D23/249
4,909,270	A	3/1990	Enterante, Sr. et al.	
D316,292	S *	4/1991	Baker	D23/249
5,029,603	A	7/1991	Ackroyd	
5,117,871	A *	6/1992	Gardner et al.	137/855
5,129,416	A	7/1992	Ackroyd	
D424,168	S	5/2000	Higgins	
6,401,745	B1	6/2002	Corder	
D493,209	S	7/2004	Wade	
D498,514	S *	11/2004	Haug et al.	D23/223
6,910,495	B2	6/2005	Lafalce	

D522,619	S *	6/2006	Scaramucci et al.	D23/249
7,055,544	B2	6/2006	Davidson	
7,128,091	B2	10/2006	Istre, Jr.	
7,174,911	B2	2/2007	Davidson	
7,191,666	B2 *	3/2007	Parris et al.	73/861.27
7,240,688	B2	7/2007	Davidson, Sr. et al.	
D550,816	S *	9/2007	Grether	D23/249
D584,384	S *	1/2009	Schönherr et al.	D23/254
D591,403	S *	4/2009	Grether	D23/249
D591,831	S *	5/2009	German et al.	D23/249
D598,008	S *	8/2009	Shimizu	D14/218
2001/0019119	A1 *	9/2001	Alves et al.	251/305
2005/0092372	A1 *	5/2005	Wade	137/527.6

FOREIGN PATENT DOCUMENTS

EP	0 113 913	B1	7/1984
EP	1 010 821	A1	6/2000
EP	1 010 822	A1	6/2000

* cited by examiner

Primary Examiner—Cathron C Brooks

Assistant Examiner—Austin Murphy

(74) *Attorney, Agent, or Firm*—Alston & Bird LLP

(57) **CLAIM**

The ornamental design for a flapper disc, as shown and described.

DESCRIPTION

FIG. 1 is a perspective view of a flapper disc design of the present invention;

FIG. 2 is a front view of the flapper disc design of the present invention;

FIG. 3 is a rear view of the flapper disc design of the present invention;

FIG. 4 is a side view of the flapper disc design of the present invention;

FIG. 5 is top view of the flapper disc design of the present invention;

FIG. 6 is a bottom view of the flapper disc design of the present invention; and,

FIG. 7 is another side view of the flapper disc design of the present invention.

1 Claim, 7 Drawing Sheets

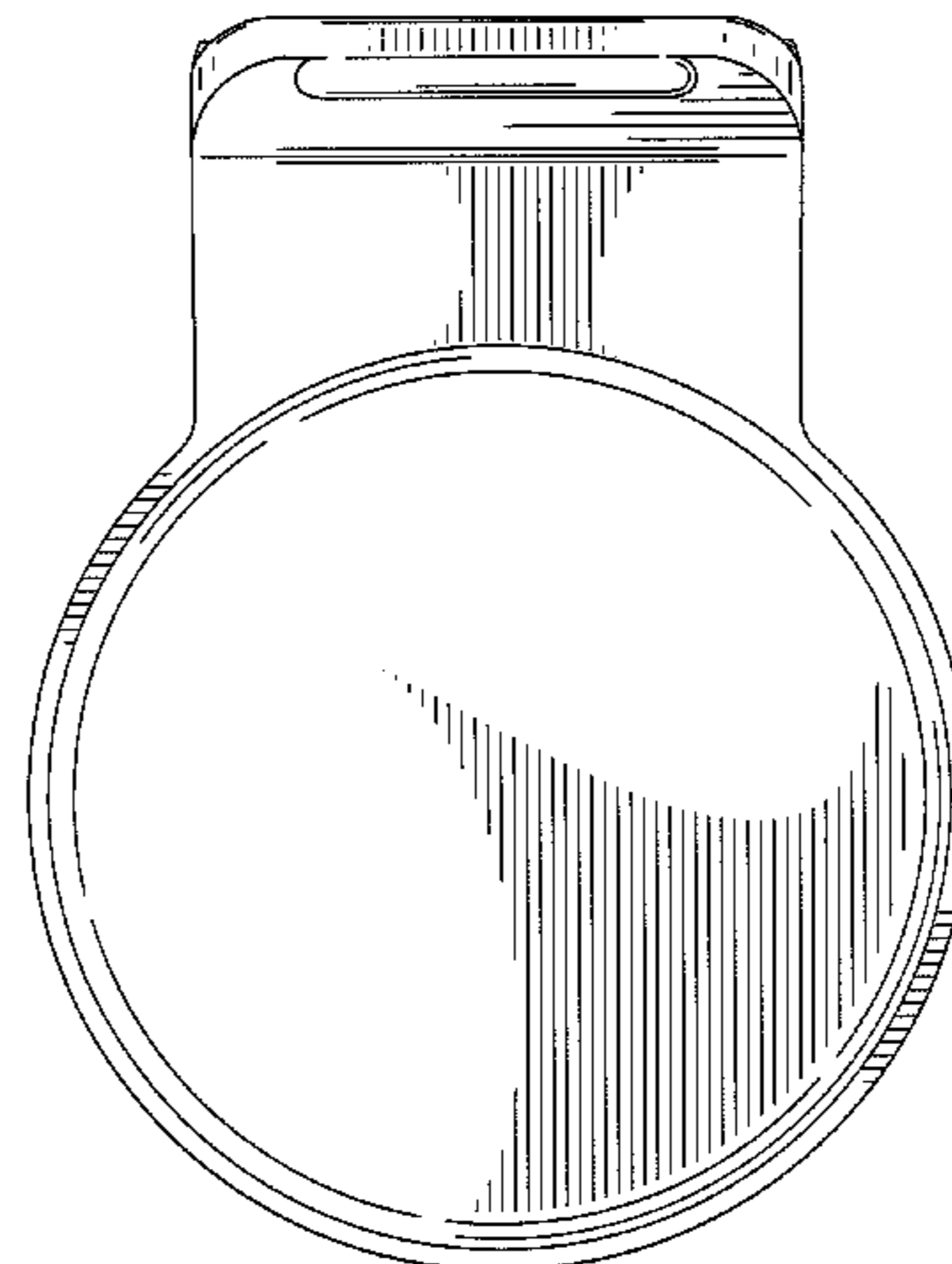
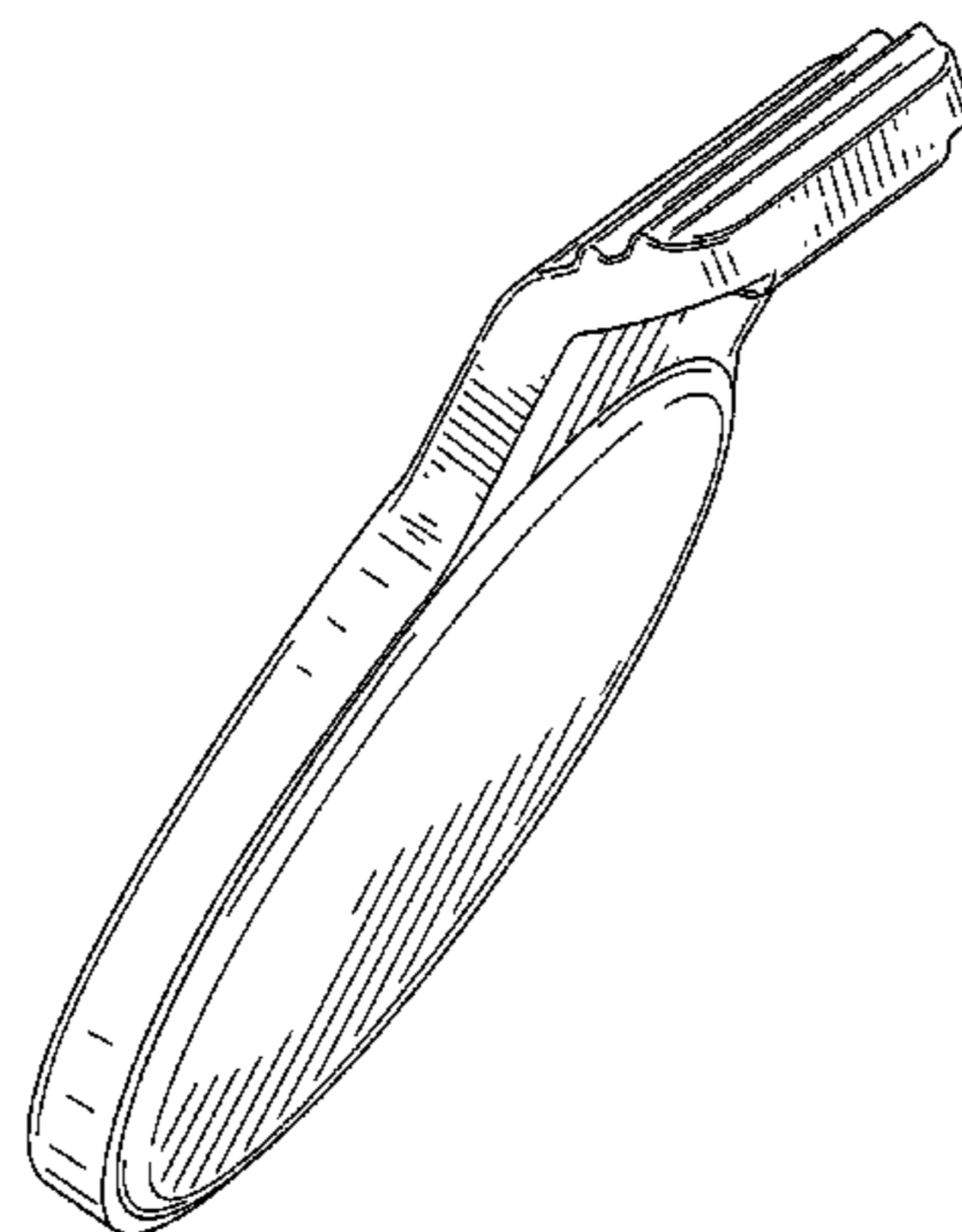

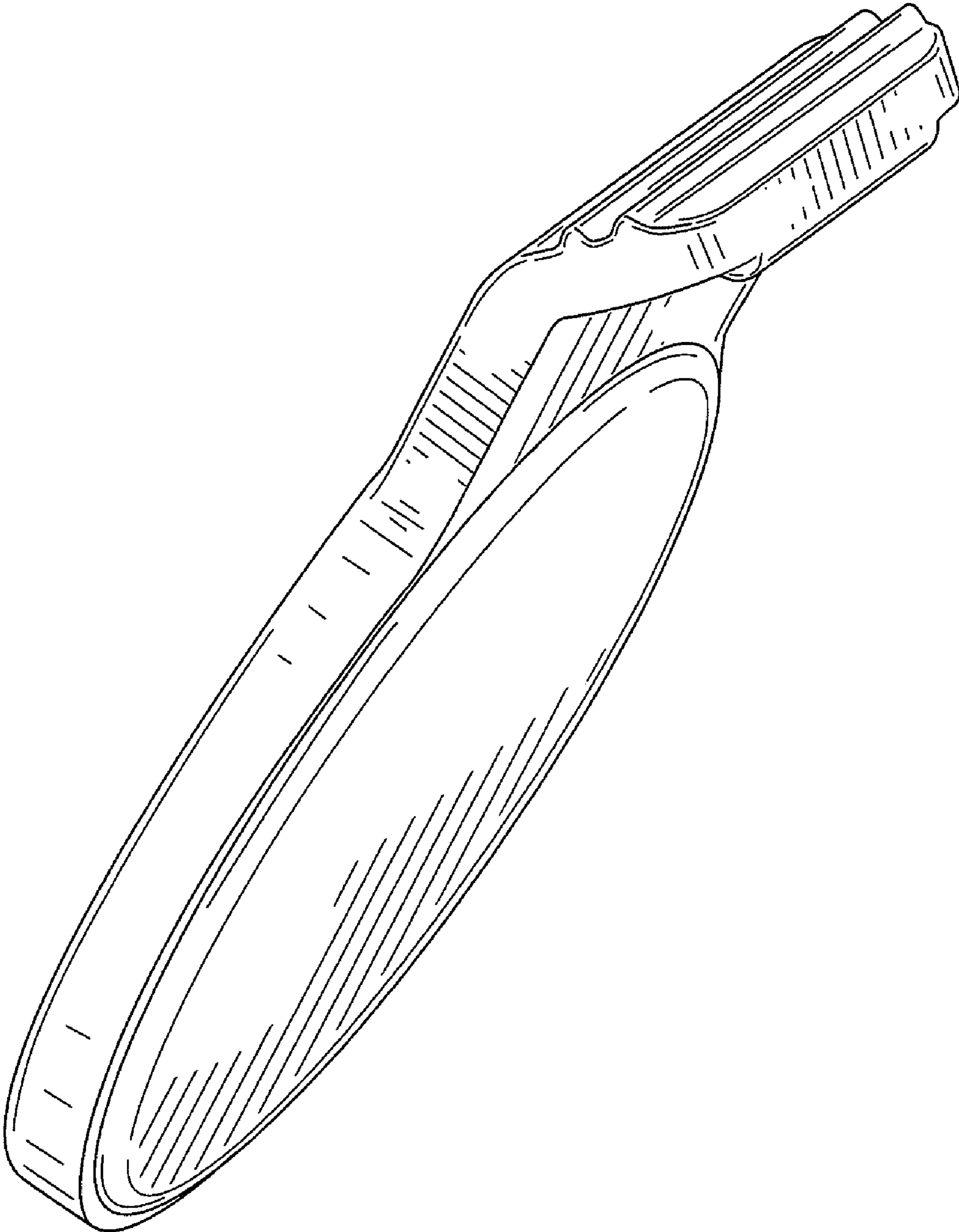

FIG. 1

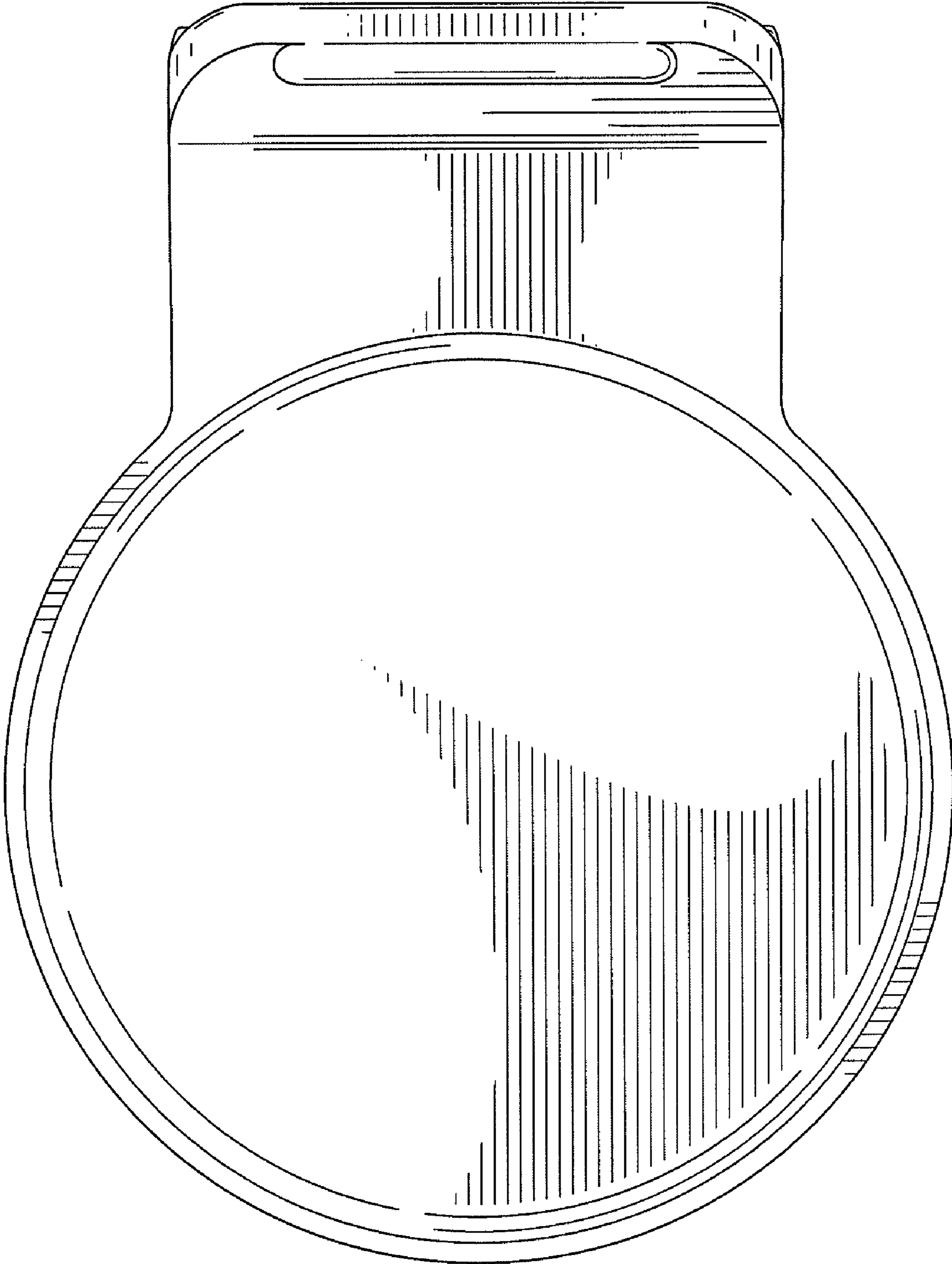

FIG. 2

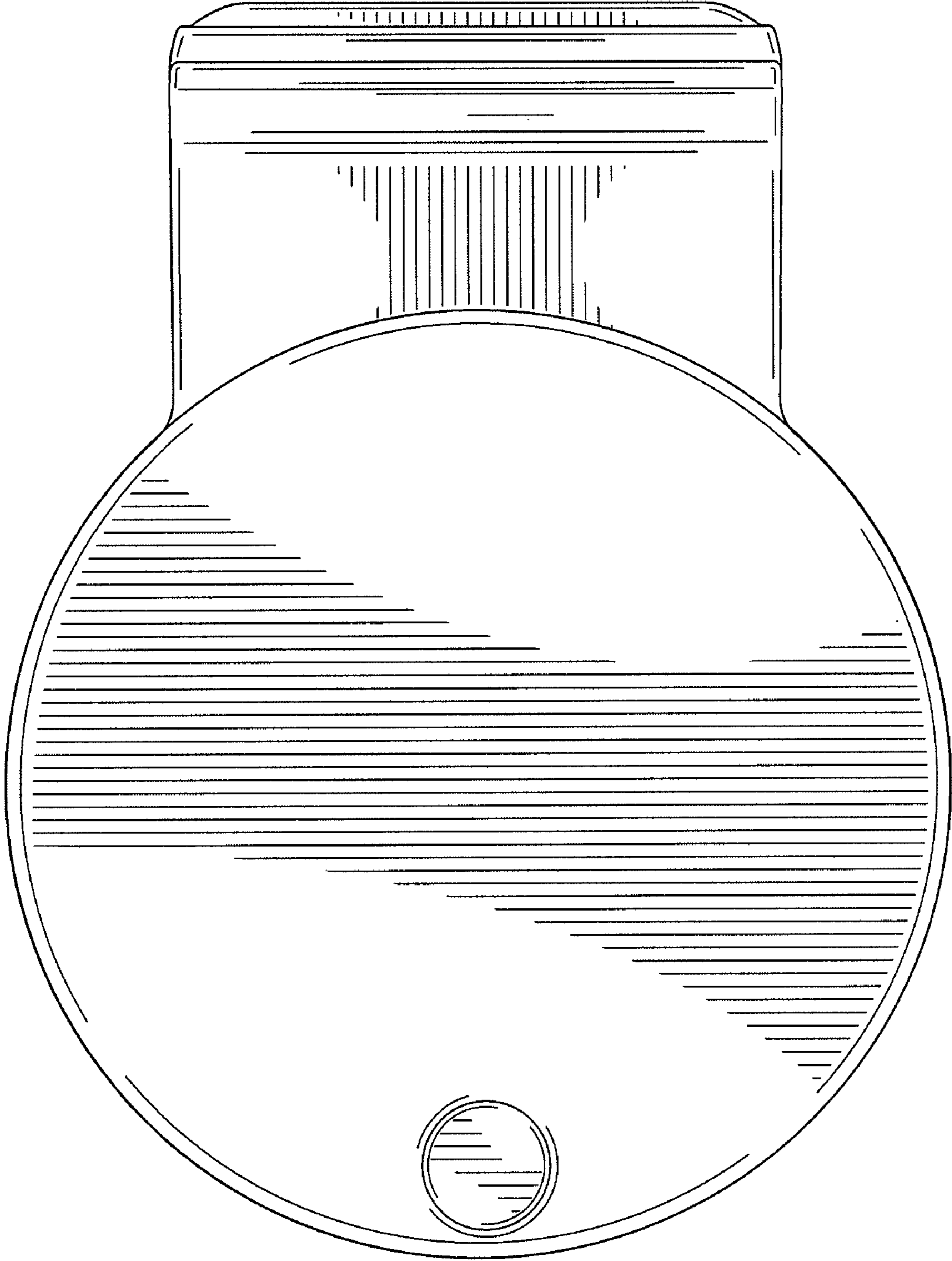

FIG. 3

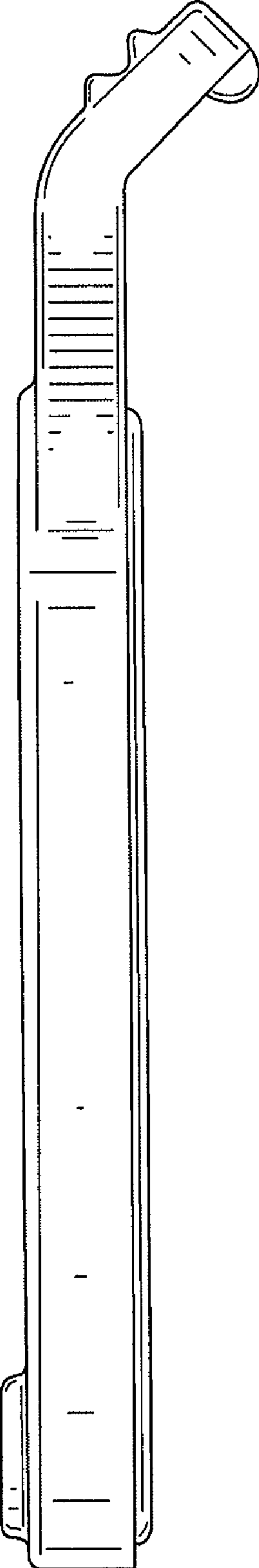

FIG. 4

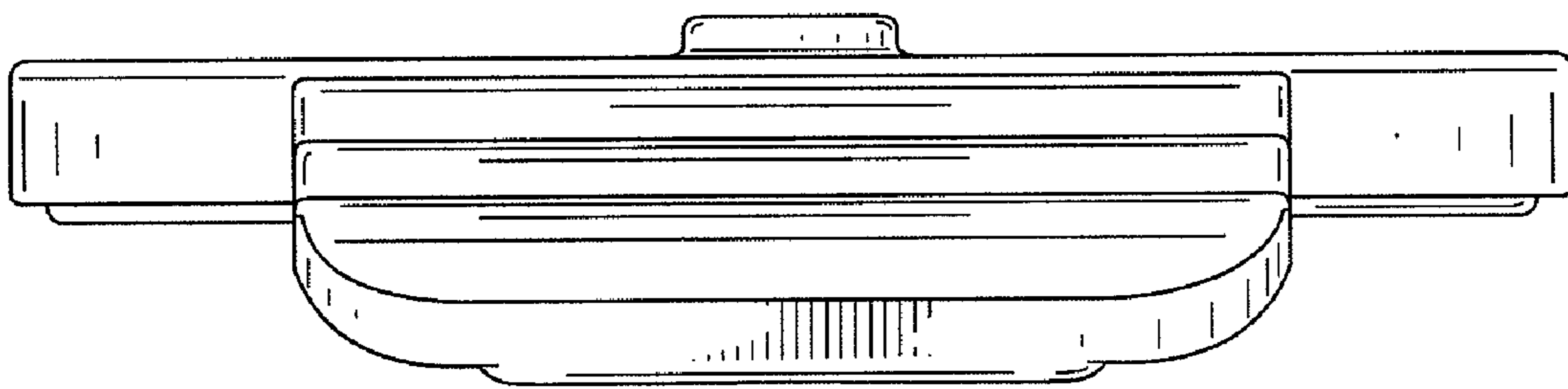

FIG. 5

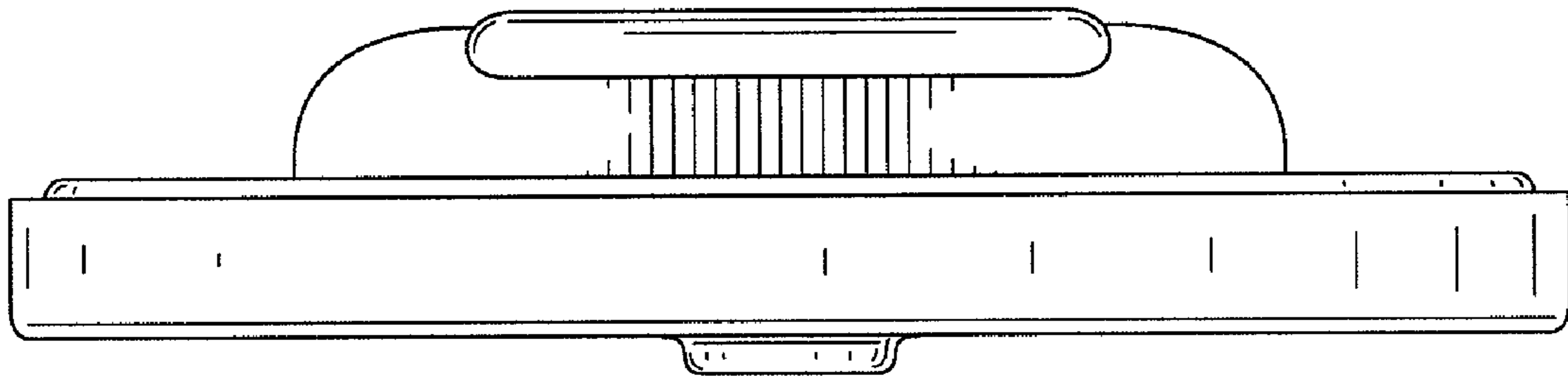

FIG. 6

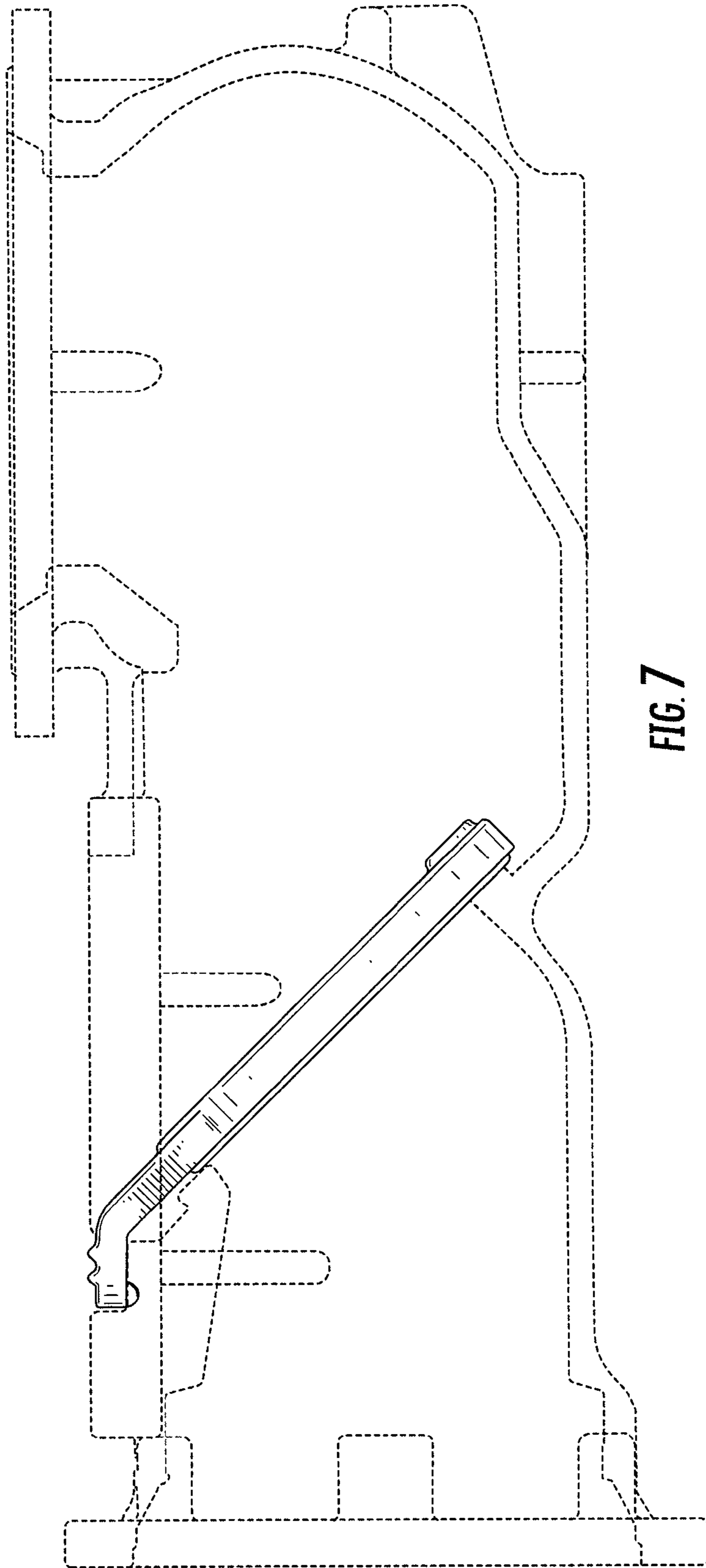

FIG. 7