

US00D607534S

(12) **United States Design Patent**
Akiba et al.

(10) **Patent No.:** **US D607,534 S**
(45) **Date of Patent:** **** Jan. 5, 2010**

(54) **REEL SEAT FOR FISHING ROD**

D593,639 S * 6/2009 Akiba et al. D22/142

(75) Inventors: **Masaru Akiba**, Higashikurume (JP);
Ryosuke Imai, Higashikurume (JP);
Shinya Takizawa, Musashino (JP)

* cited by examiner

Primary Examiner—Catherine R Oliver
(74) *Attorney, Agent, or Firm*—Sughrue Mion, PLLC

(73) Assignee: **Daiwa Seiko, Inc.**, Higashikurume (JP)

(57) **CLAIM**

(**) Term: **14 Years**

The ornamental design for a reel seat for fishing rod, as shown and described.

(21) Appl. No.: **29/334,310**

(22) Filed: **Mar. 24, 2009**

DESCRIPTION

(30) **Foreign Application Priority Data**

Nov. 28, 2008 (JP) 2008-030630

FIG. 1 is a top perspective view of the reel seat for fishing rod according to the present invention;

FIG. 2 is a bottom perspective view thereof;

FIG. 3 is a side view thereof;

(51) **LOC (9) Cl.** **22-05**

(52) **U.S. Cl.** **D22/142**

(58) **Field of Classification Search** D22/142,
D22/134, 137–139; 43/20, 22–23

FIG. 4 is a side view thereof opposite from the side view of FIG. 3;

FIG. 5 is an end view thereof;

See application file for complete search history.

FIG. 6 is an end view thereof opposite from the end view of FIG. 5;

FIG. 7 is a top view thereof;

(56) **References Cited**

U.S. PATENT DOCUMENTS

D316,738 S *	5/1991	Oyama	D22/142
D317,345 S *	6/1991	Oyama	D22/142
D389,554 S *	1/1998	Ohmura	D22/142
D569,945 S *	5/2008	Omura	D22/142
D569,946 S *	5/2008	Omura	D22/142

FIG. 8 is a bottom view thereof; and,

FIG. 9 is a cross-sectional view taken along line 9—9 in FIG. 7.

1 Claim, 6 Drawing Sheets

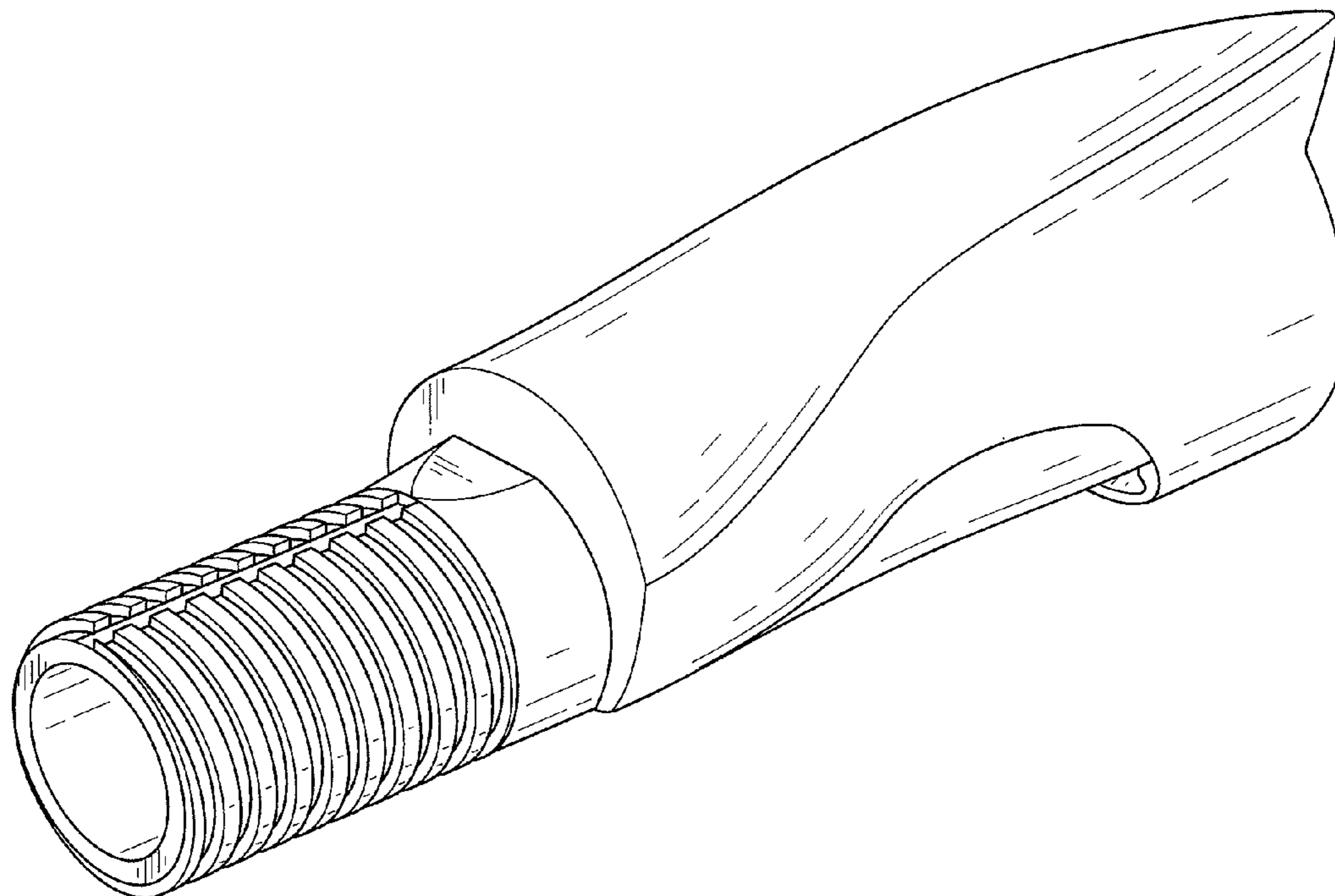

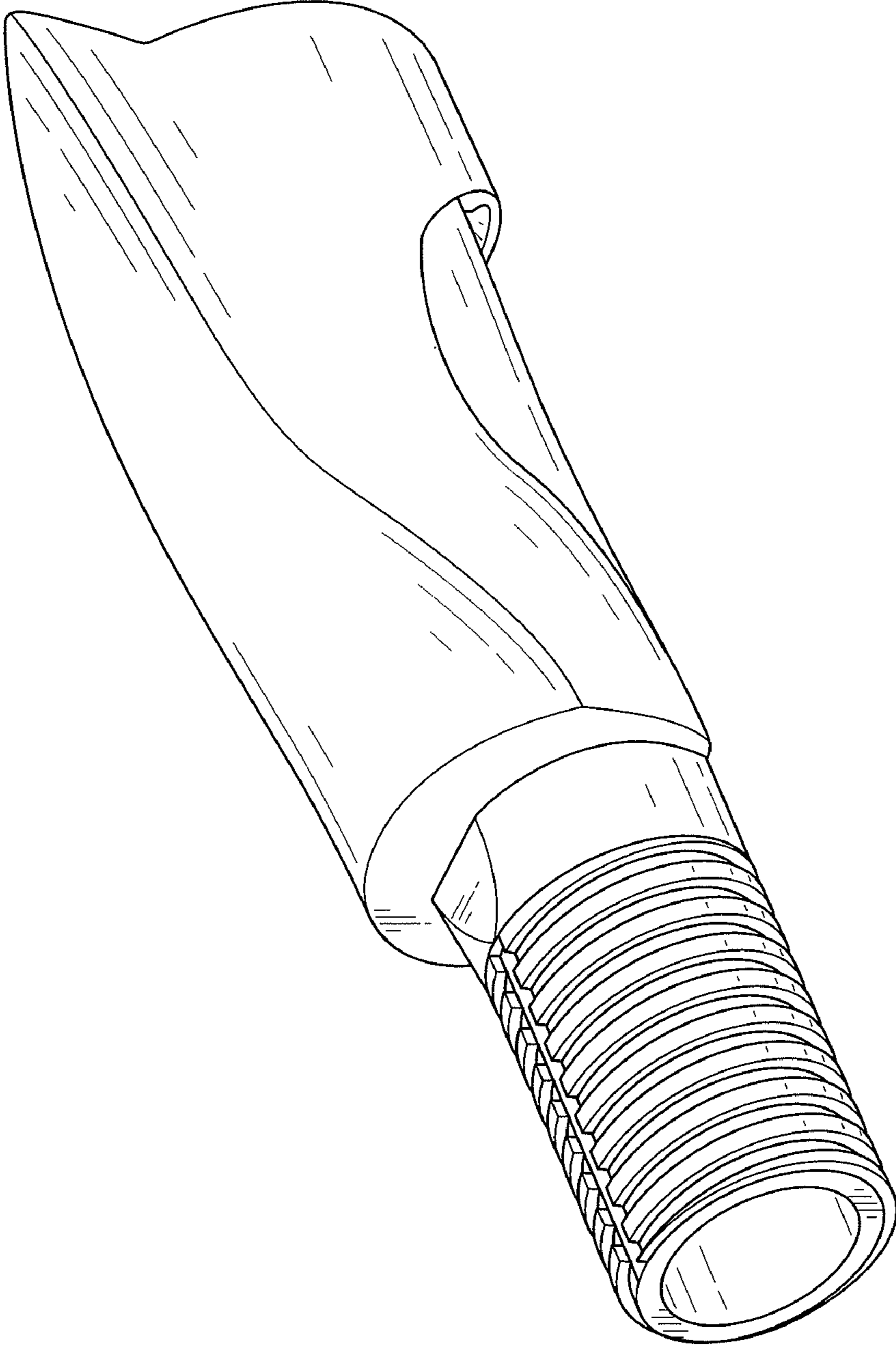

FIG. 1

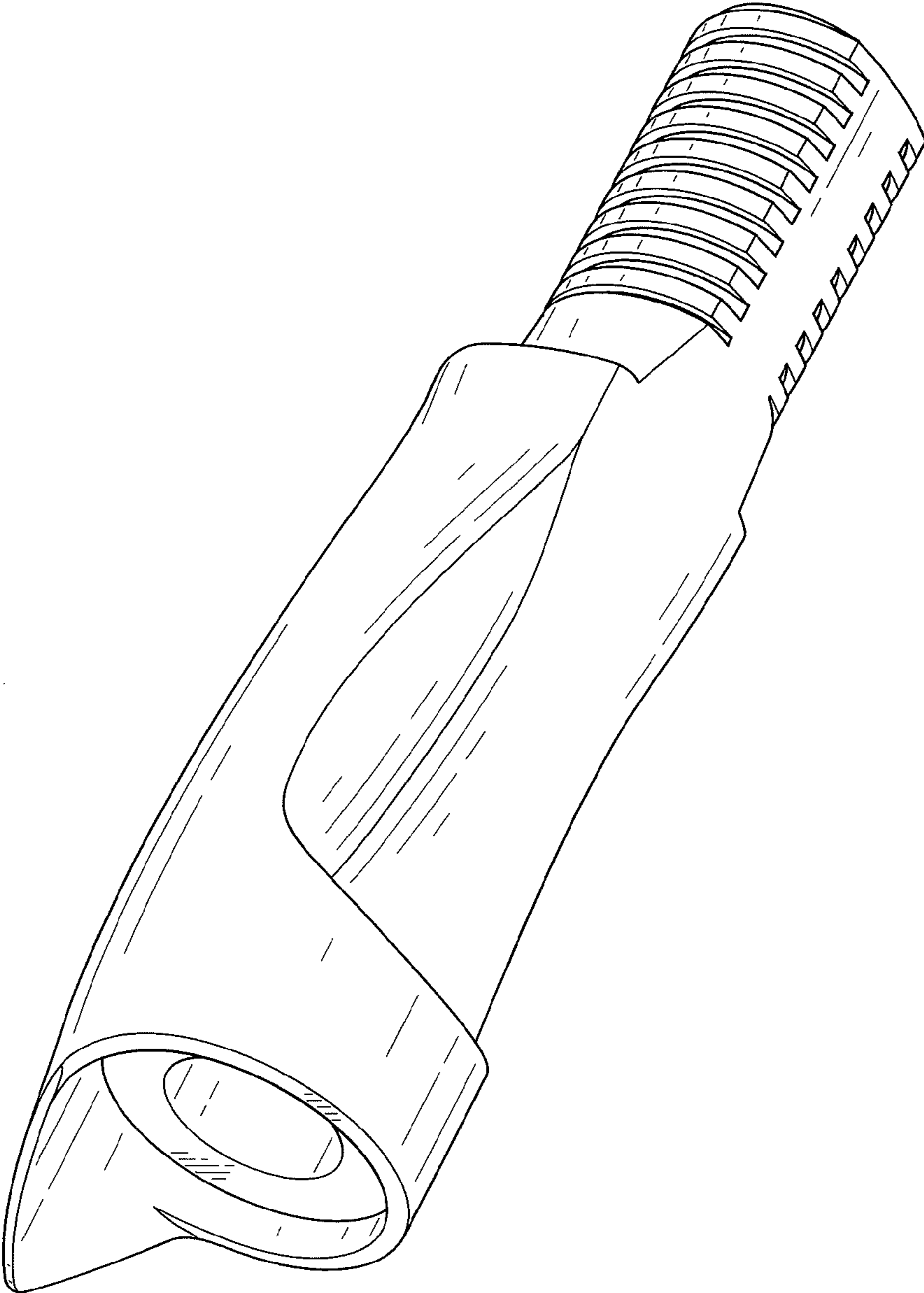

FIG. 2

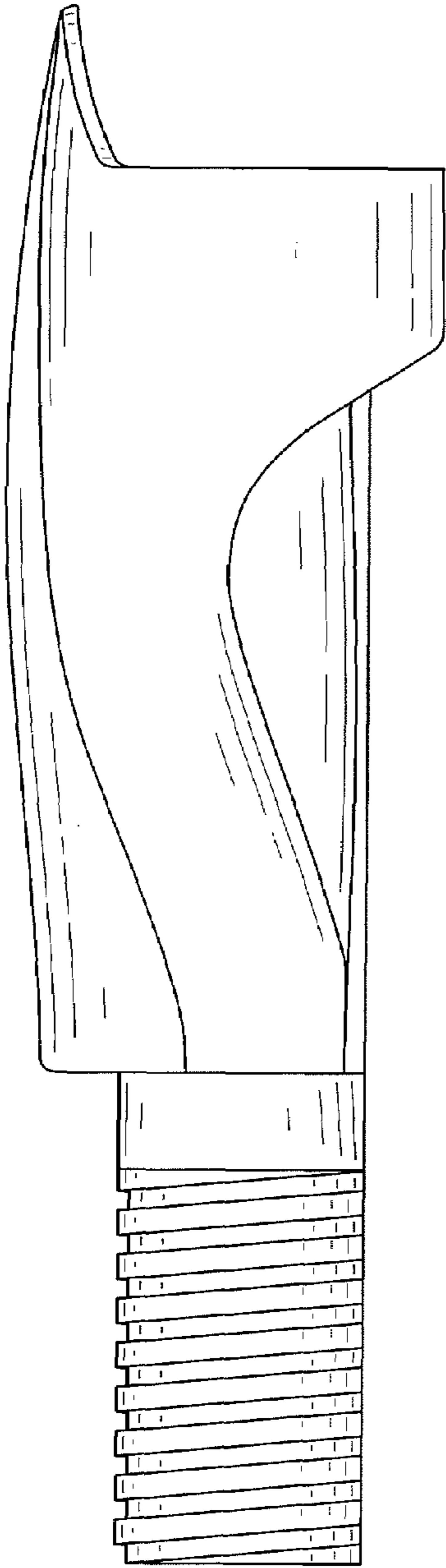

FIG. 3

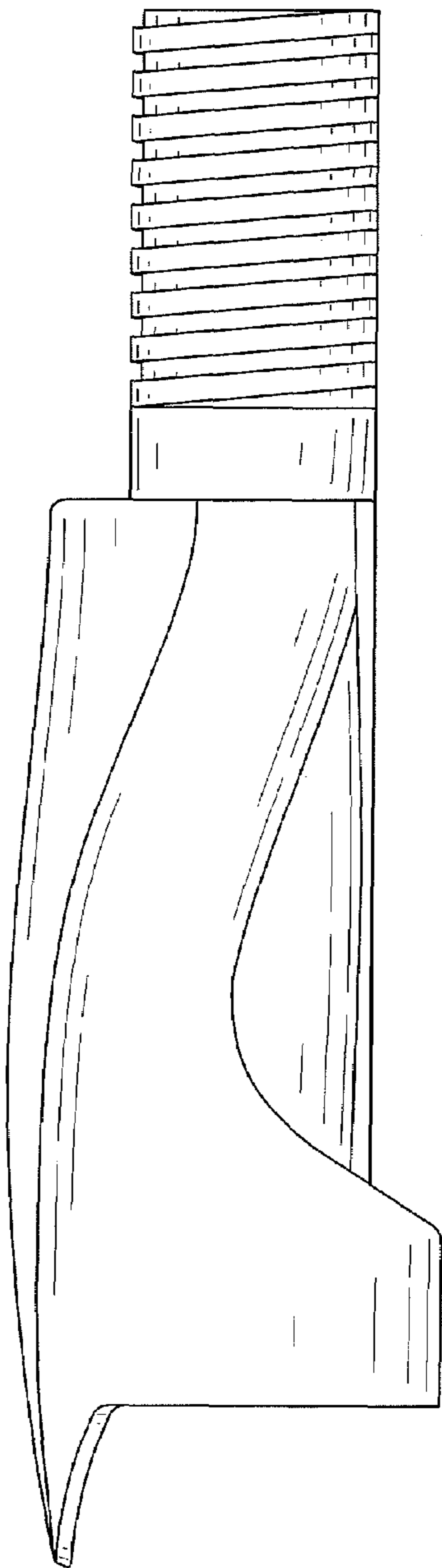

FIG. 4

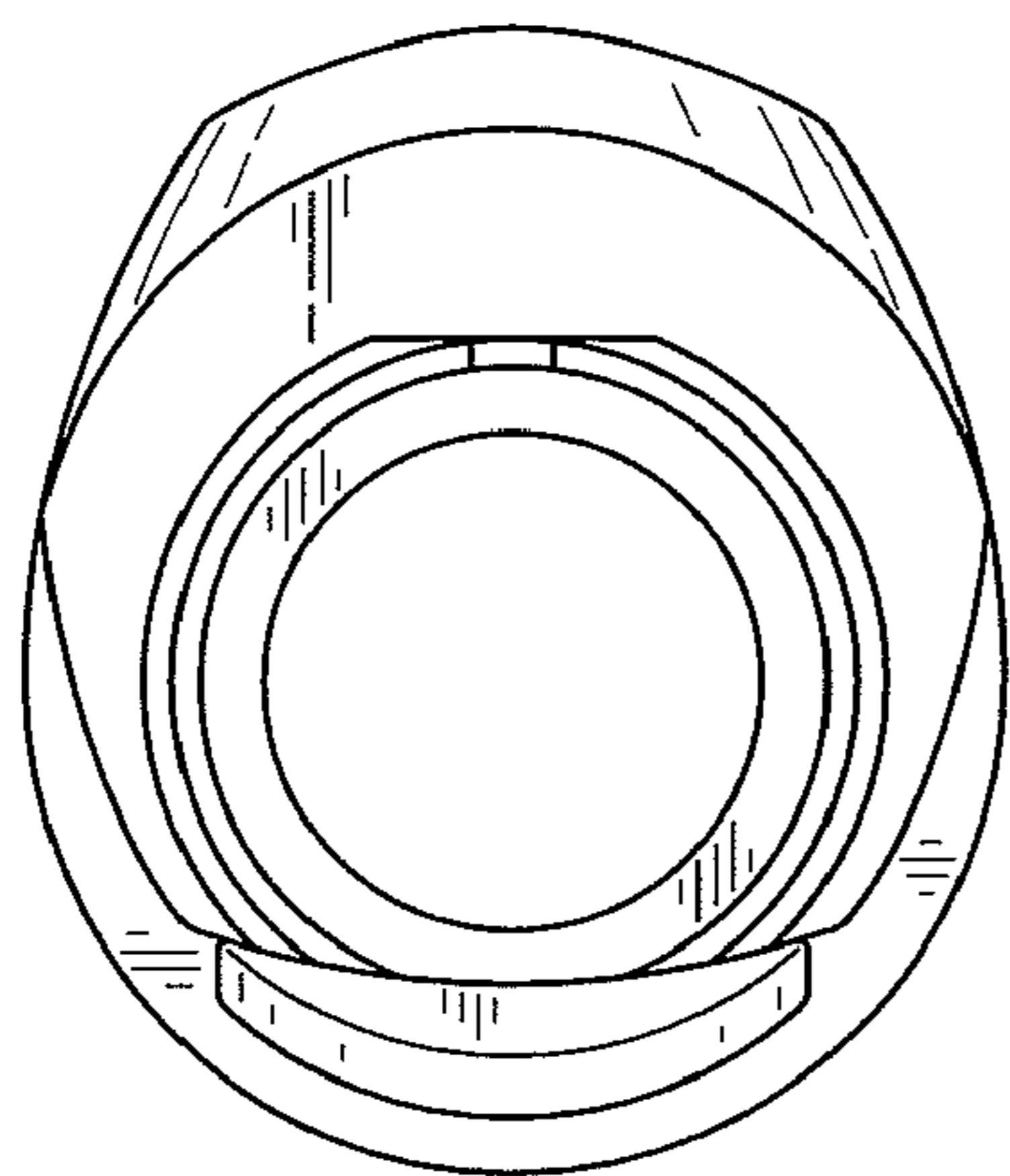

FIG. 5

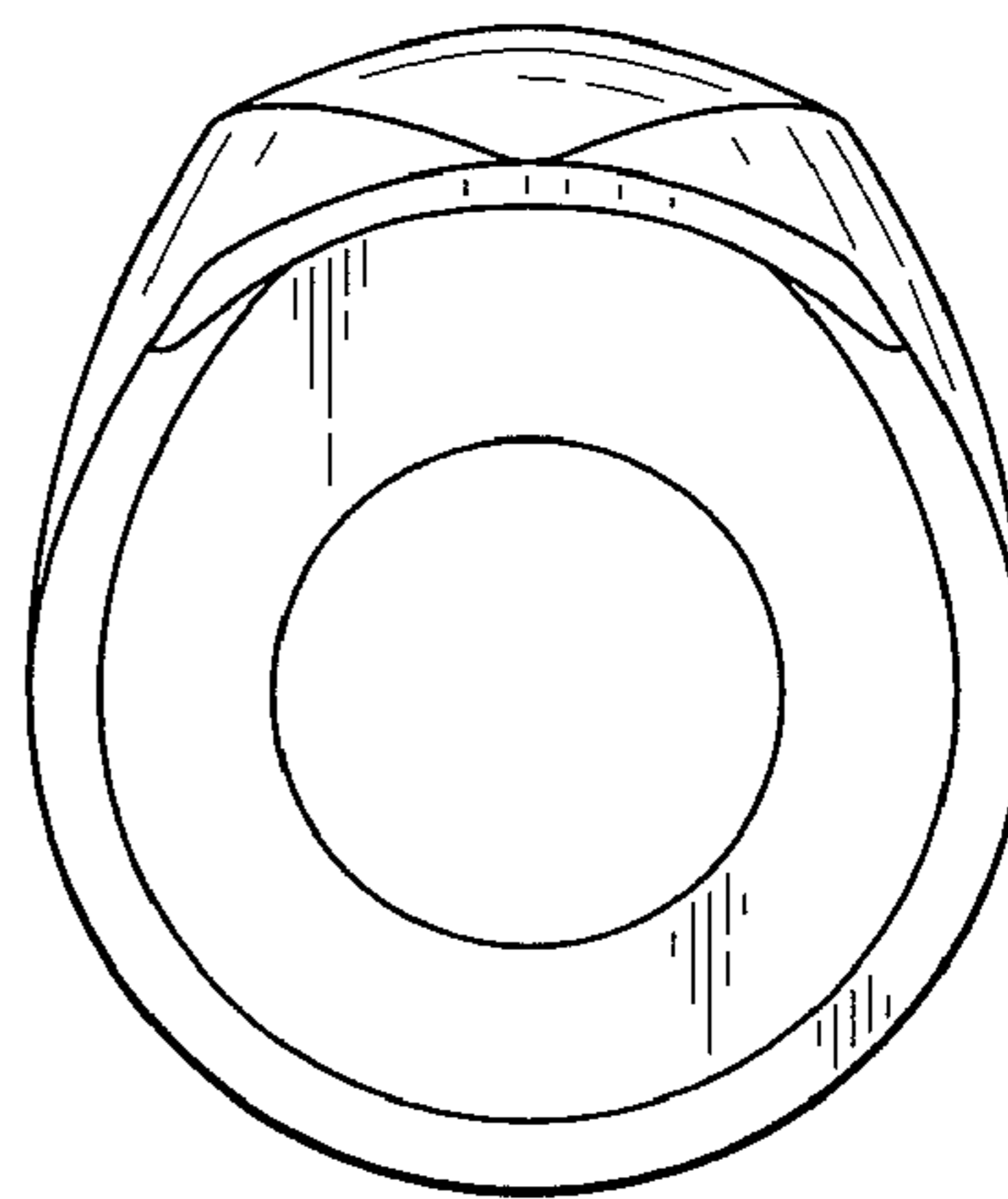

FIG. 6

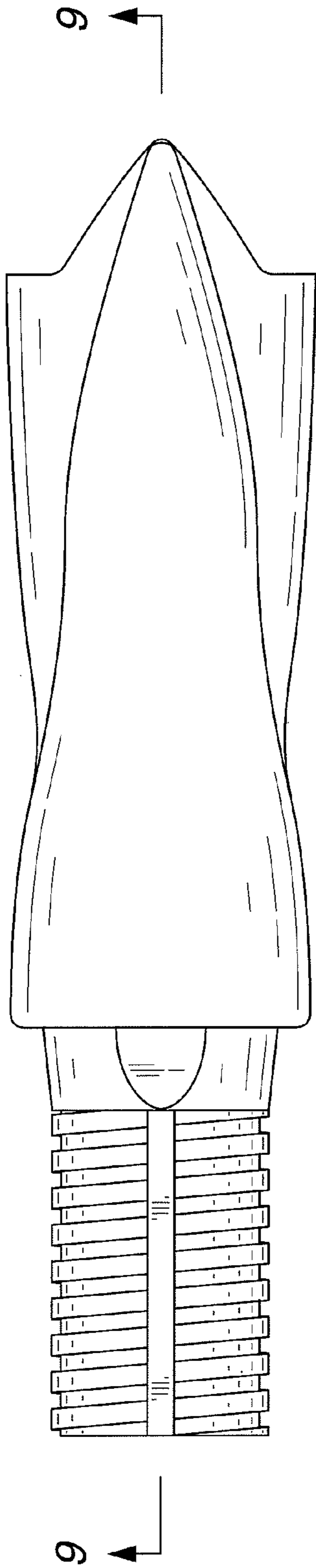

FIG. 7



FIG. 8

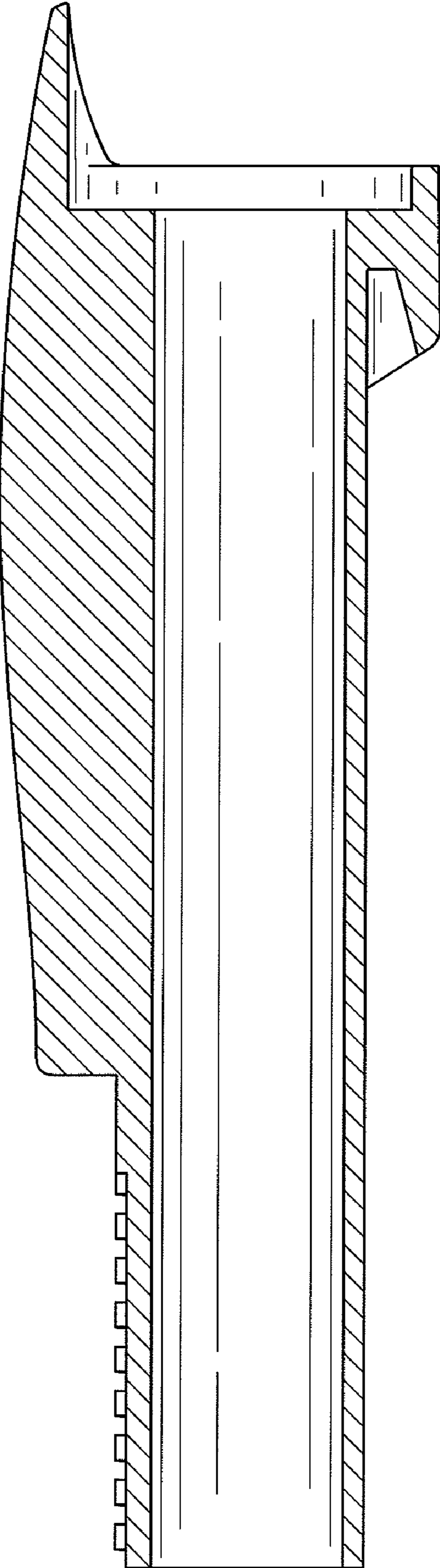

FIG. 9