



US00D607428S

(12) **United States Design Patent**  
**Kim et al.**

(10) **Patent No.:** **US D607,428 S**  
(45) **Date of Patent:** **\*\* Jan. 5, 2010**

(54) **MOBILE PHONE**

(75) Inventors: **Eun-Young Kim**, Seoul (KR);  
**Young-Ju Yeo**, Seoul (KR);  
**Chang-Hwan Hwang**, Goyang-si (KR)

(73) Assignee: **Samsung Electronics Co., Ltd.**,  
Suwon-si (KR)

(\*\*) Term: **14 Years**

(21) Appl. No.: **29/332,134**

(22) Filed: **Feb. 10, 2009**

(30) **Foreign Application Priority Data**

Nov. 27, 2008 (KR) ..... 30-2008-0051035

(51) **LOC (9) Cl.** ..... **14-03**

(52) **U.S. Cl.** ..... **D14/138 AD**

(58) **Field of Classification Search** ..... D14/138 R,  
D14/138 AD, 138 AC, 138 C, 138 G, 191,  
D14/203.1–203.8, 496, 138 AA, 138 AB,  
D14/247–248, 137, 147, 218, 341–347; D10/65,  
D10/78, 104; D13/168; D18/7; 455/566,  
455/575.1, 575.3

See application file for complete search history.

(56) **References Cited**

**U.S. PATENT DOCUMENTS**

D498,754 S \* 11/2004 Blyth ..... D14/341  
D503,699 S \* 4/2005 Lee et al. .... D14/138 AD  
D509,202 S \* 9/2005 Lee et al. .... D14/138 AD  
D512,393 S \* 12/2005 Lee et al. .... D14/138 AD  
D527,717 S \* 9/2006 Kim ..... D14/138 AD  
D530,295 S \* 10/2006 Chung et al. .... D14/138 AD  
D533,531 S \* 12/2006 Hyun et al. .... D14/138 AD  
D537,063 S \* 2/2007 Kim et al. .... D14/138 AD  
D541,249 S \* 4/2007 Hirano ..... D14/138 AC  
D544,459 S \* 6/2007 Wang ..... D14/138 AD  
D549,683 S \* 8/2007 Cho et al. .... D14/138 AD  
D556,169 S \* 11/2007 Choi ..... D14/138 AD  
D561,781 S \* 2/2008 Park ..... D14/496

D565,533 S \* 4/2008 Kim et al. .... D14/138 AD  
D567,125 S \* 4/2008 Okabe et al. .... D10/81  
D571,765 S \* 6/2008 Hsu ..... D14/138 AD  
D572,695 S \* 7/2008 Tu ..... D14/138 AD  
D573,129 S \* 7/2008 Park et al. .... D14/138 AD  
D574,806 S \* 8/2008 Lee et al. .... D14/138 AD  
D579,899 S \* 11/2008 Park et al. .... D14/138 AD  
D581,390 S \* 11/2008 Ma et al. .... D14/138 AD  
D582,382 S \* 12/2008 Kim ..... D14/138 AD  
D585,416 S \* 1/2009 Kim ..... D14/138 AD  
D596,607 S \* 7/2009 Kim et al. .... D14/138 AD  
2005/0014538 A1 \* 1/2005 Hyun et al. .... 455/575.4  
2008/0266378 A1 \* 10/2008 Ryu ..... 348/14.02

**OTHER PUBLICATIONS**

Asus P320, announced Mar. 2008, [online], [retrieved on May 14, 2008]. Retrieved from Internet, <URL: <http://www.gsmarena.com>>.\*

(Continued)

*Primary Examiner*—Jeffrey D Asch  
*Assistant Examiner*—Bridget L Eland  
(74) *Attorney, Agent, or Firm*—Staas & Halsey LLP

(57) **CLAIM**

The ornamental design for a mobile phone, as shown and described.

**DESCRIPTION**

FIG. 1 is a front perspective view of a mobile phone;  
FIG. 2 is a front view of the mobile phone of FIG. 1;  
FIG. 3 is a rear view of the mobile phone of FIG. 1;  
FIG. 4 is a left-side view of the mobile phone of FIG. 1;  
FIG. 5 is a right-side view of the mobile phone of FIG. 1;  
FIG. 6 is a top plan view of the mobile phone of FIG. 1;  
FIG. 7 is a bottom plan view of the mobile phone of FIG. 1;  
and,  
FIG. 8 is a slid-open view of the mobile phone of FIG. 1.

**1 Claim, 5 Drawing Sheets**

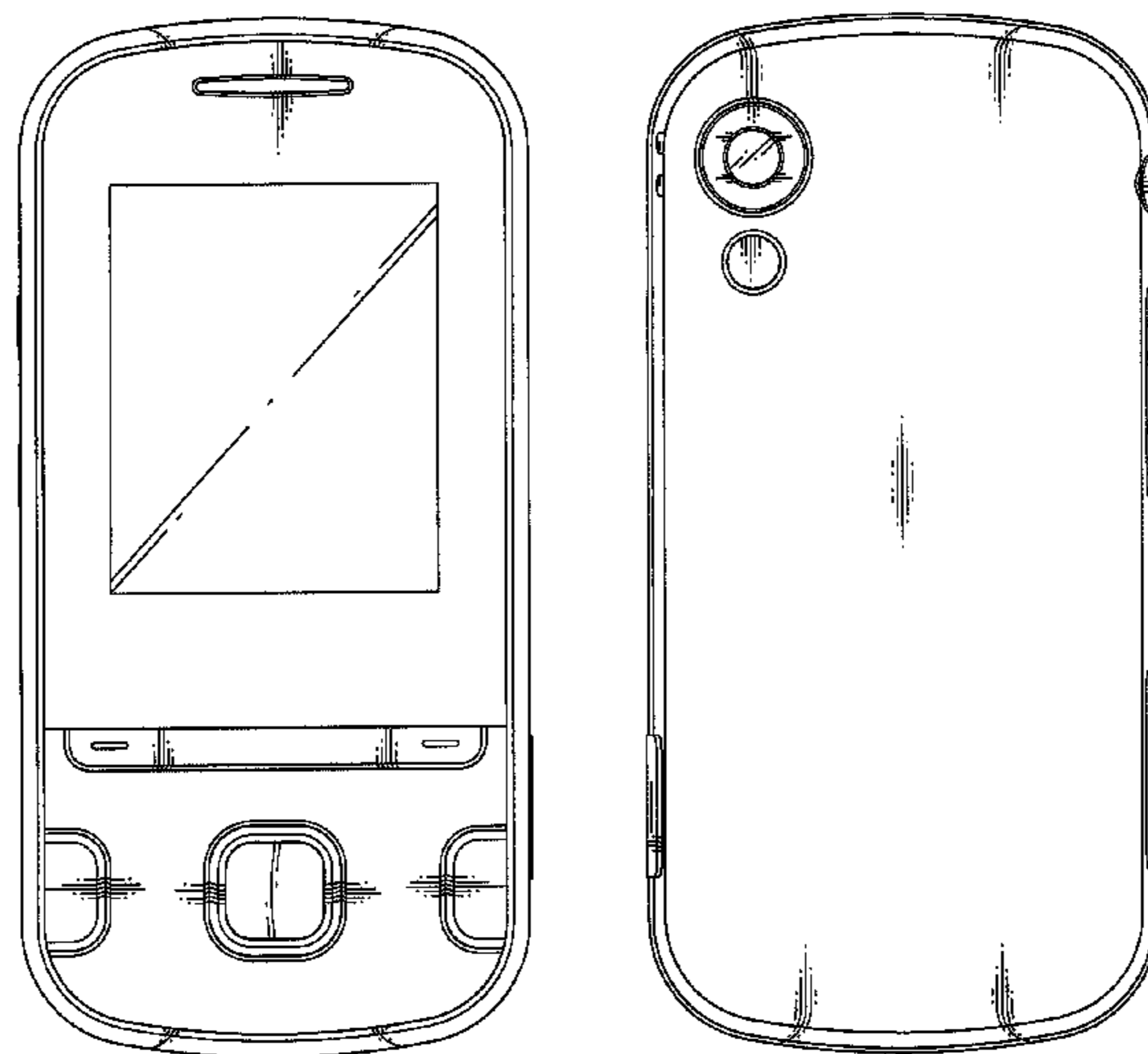

OTHER PUBLICATIONS

LG KE260, announced Nov. 2006, [online], [retrieved on Feb. 20, 2007]. Retrieved from Internet, <URL: <http://www.gsmarena.com>>.\*

LG GM310, announced Feb. 2009, [online], [retrieved on Feb. 20, 2009]. Retrieved from Internet, <URL: <http://www.gsmarena.com>>.\*

Motorola VE75, announced Jul. 2008, [online], [retrieved on Aug. 15, 2008]. Retrieved from Internet, <URL: <http://www.gsmarena.com>>.\*

Qtek A9100, announced Mar. 2006, [online], [retrieved on Nov. 8, 2008]. Retrieved from Internet, <URL: <http://www.gsmarena.com>>.\*

Samsung i8510 INNOV8, announced Jul. 2008, [online], [retrieved on Jul. 25, 2008]. Retrieved from Internet, <URL: <http://www.gsmarena.com>>.\*

Sony Ericsson W760, announced Jan. 2008, [online], [retrieved on Jan. 18, 2008]. Retrieved from Internet, <URL: <http://www.gsmarena.com>>.\*

Sony Ericsson W995, announced Feb. 2009, [online], [retrieved on Feb. 20, 2009]. Retrieved from Internet, <URL: <http://www.gsmarena.com>>.\*

\* cited by examiner

FIG. 1

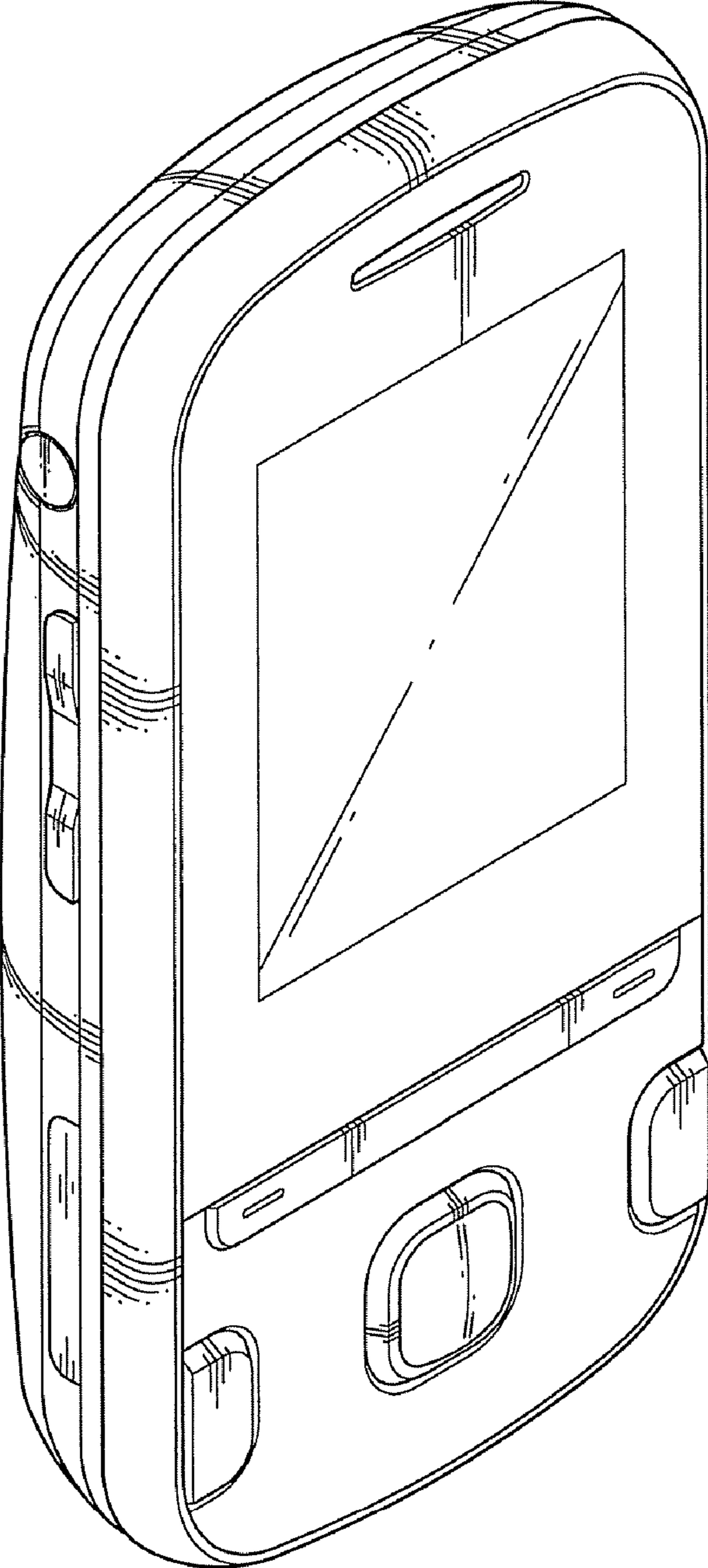

FIG.2

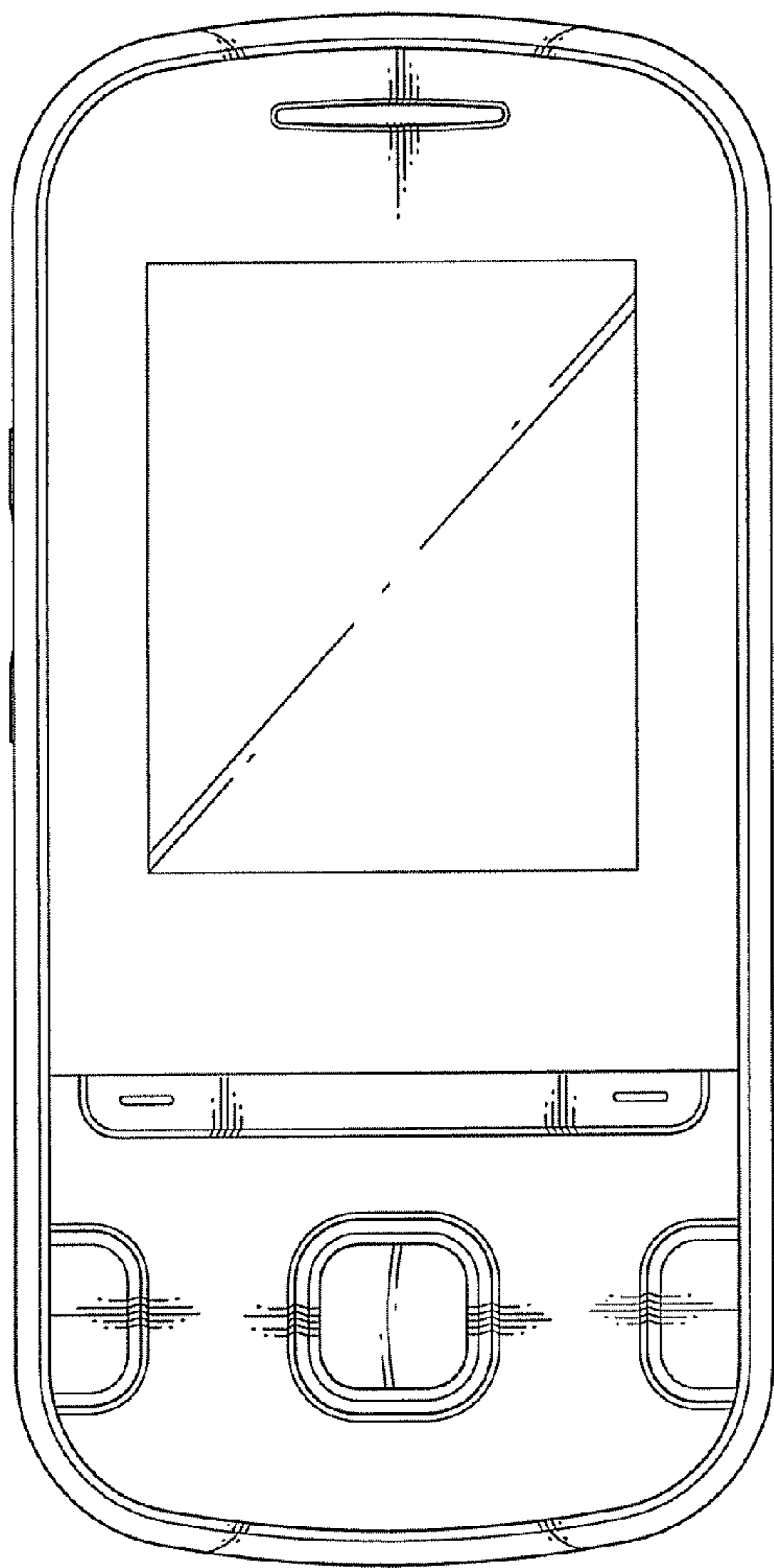

FIG.3

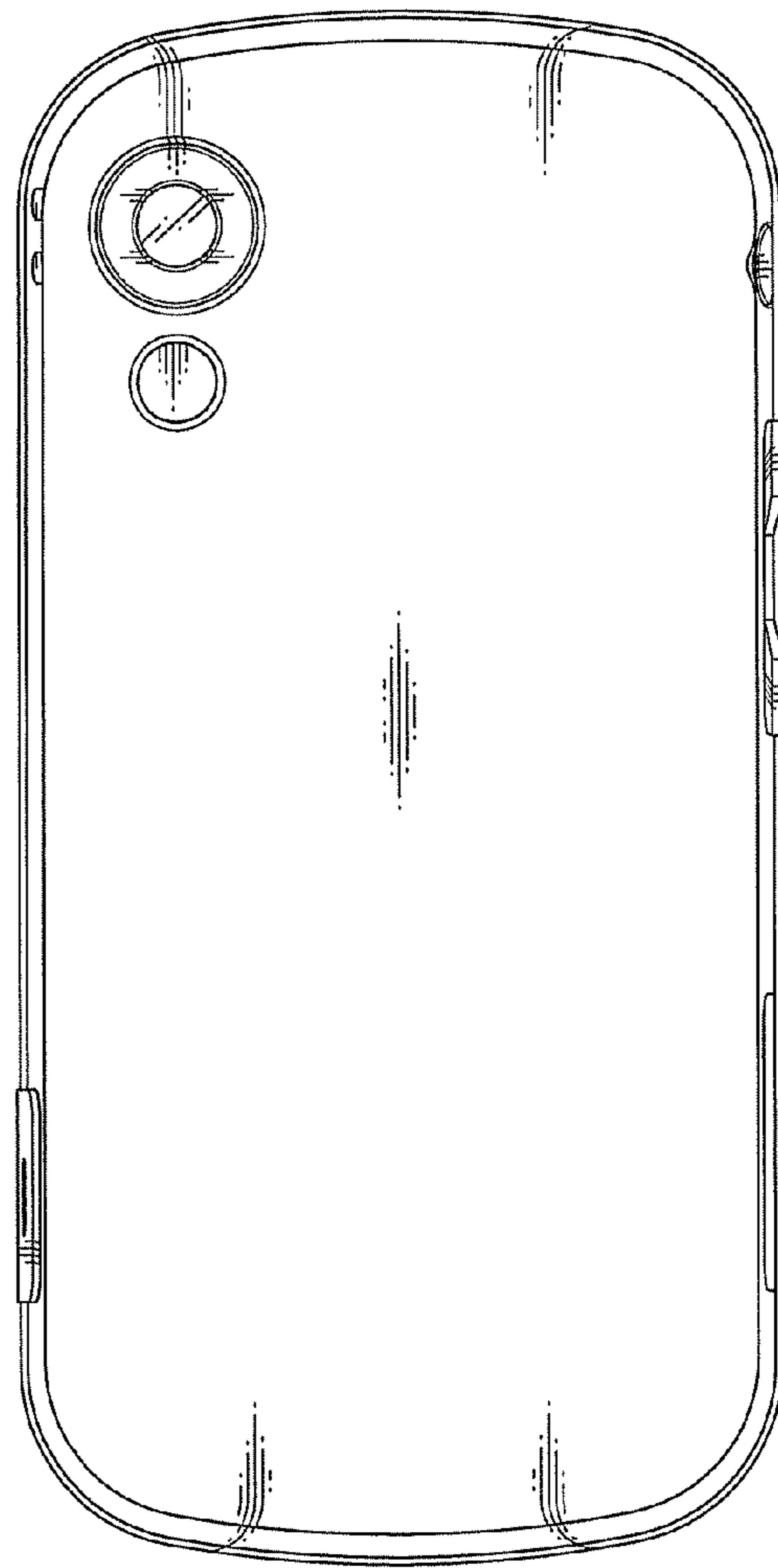



FIG. 4

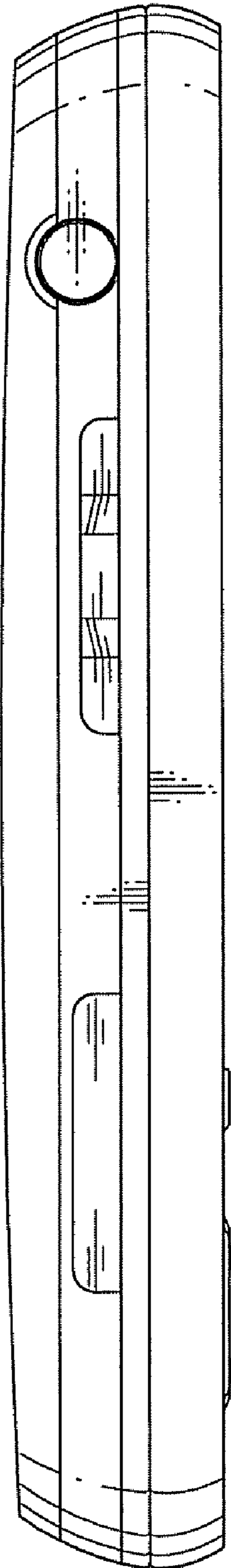

FIG. 5

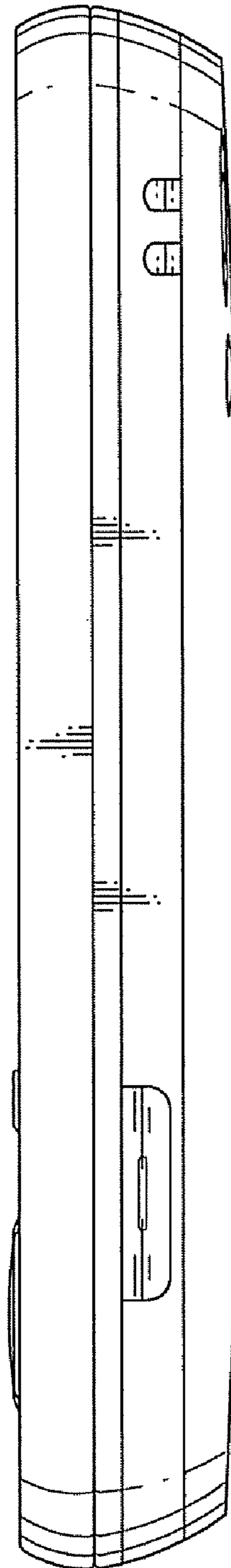

FIG. 6

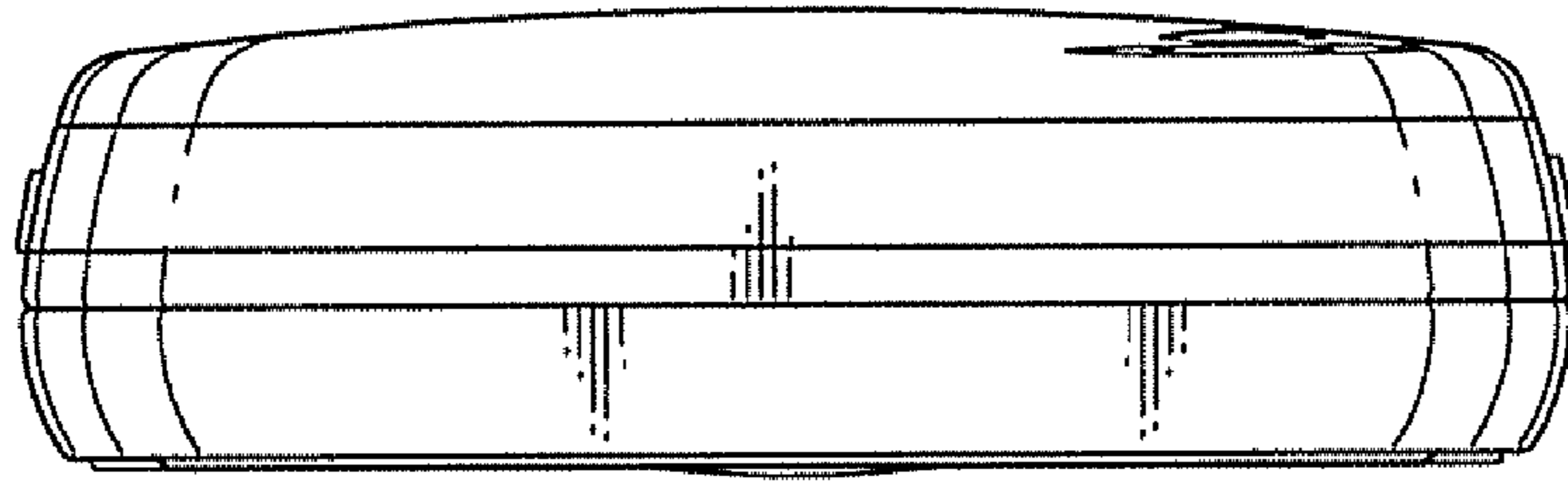

FIG. 7

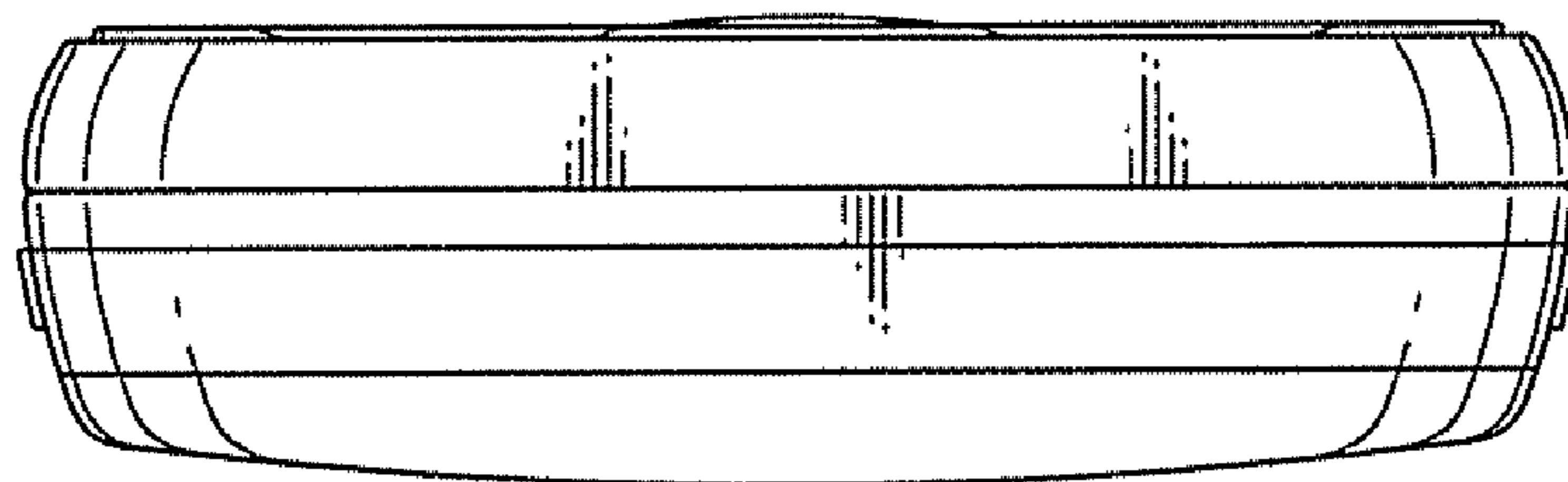

FIG. 8

