



US00D607376S

(12) **United States Design Patent**
Buday

(10) **Patent No.:** **US D607,376 S**
(45) **Date of Patent:** **** Jan. 5, 2010**

(54) **BUCKLE**

(76) Inventor: **Alexander Buday**, Visnova 18, Nitra
SK-949 01 (SK)

(**) Term: **14 Years**

(21) Appl. No.: **29/308,752**

(22) Filed: **Jul. 3, 2008**

(51) **LOC (9) Cl.** **02-07**

(52) **U.S. Cl.** **D11/212**

(58) **Field of Classification Search** 11/1-2,
11/200-201, 203-206, 210, 212, 214-219,
11/222, 224, 226; 24/163 R, 169-171, 173,
24/177-179, 191, 194-195, 197, 200

See application file for complete search history.

(56) **References Cited**

U.S. PATENT DOCUMENTS

D44,063 S *	5/1913	Hirsh	D11/216
D53,376 S *	5/1919	Rauch	D11/201
D147,934 S *	11/1947	Strub	D11/224
D178,017 S *	6/1956	Savino	D11/201
D196,908 S *	11/1963	Di Mascolo	D11/212
D217,419 S *	5/1970	Rotondo	D11/224
D520,738 S	5/2006	Tarantino		
D521,726 S	5/2006	Tarantino		

OTHER PUBLICATIONS

Anonymous; *Advertising Materials*; www.lanyardsupply.com (3 pages).

* cited by examiner

Primary Examiner—R. Seifert

(74) *Attorney, Agent, or Firm*—James Creighton Wray;
Meera P. Narasimhan

(57) **CLAIM**

The ornamental design for a buckle, as shown and described.

DESCRIPTION

FIG. 1 is a front perspective view of a buckle showing my new design;

FIG. 2 is a front elevational view;

FIG. 3 is a left side elevational view, the right side elevational view being a mirror image thereof;

FIG. 4 is a rear elevational view;

FIG. 5 is a bottom plan view;

FIG. 6 is a front elevational view of the upper portion of the buckle, the lower portion has been removed for ease of illustration;

FIG. 7 is a rear elevational view of FIG. 6;

FIG. 8 is a front elevational view of the lower portion of the buckle reduced in scale for illustrative purposes, the upper portion has been removed for ease of illustration shown;

FIG. 9 is a rear elevational view of FIG. 8, shown slightly enlarged;

FIG. 10 is a rear elevational view of the front segment of the lower section of the buckle shown in FIG. 8, shown slightly enlarged;

FIG. 11 is a rear elevational view of the back segment of the lower section of the buckle of FIG. 9, shown slightly reduced in scale;

FIG. 12 is a rear perspective view of FIG. 1;

FIG. 13 is a rear perspective view of FIG. 12, shown partly disassembled and slightly reduced in scale for ease of illustration; and,

FIG. 14 is rear perspective view, the front and rear segments have been illustrated partly disassembled and the upper section of the buckle removed for ease of illustration.

1 Claim, 2 Drawing Sheets

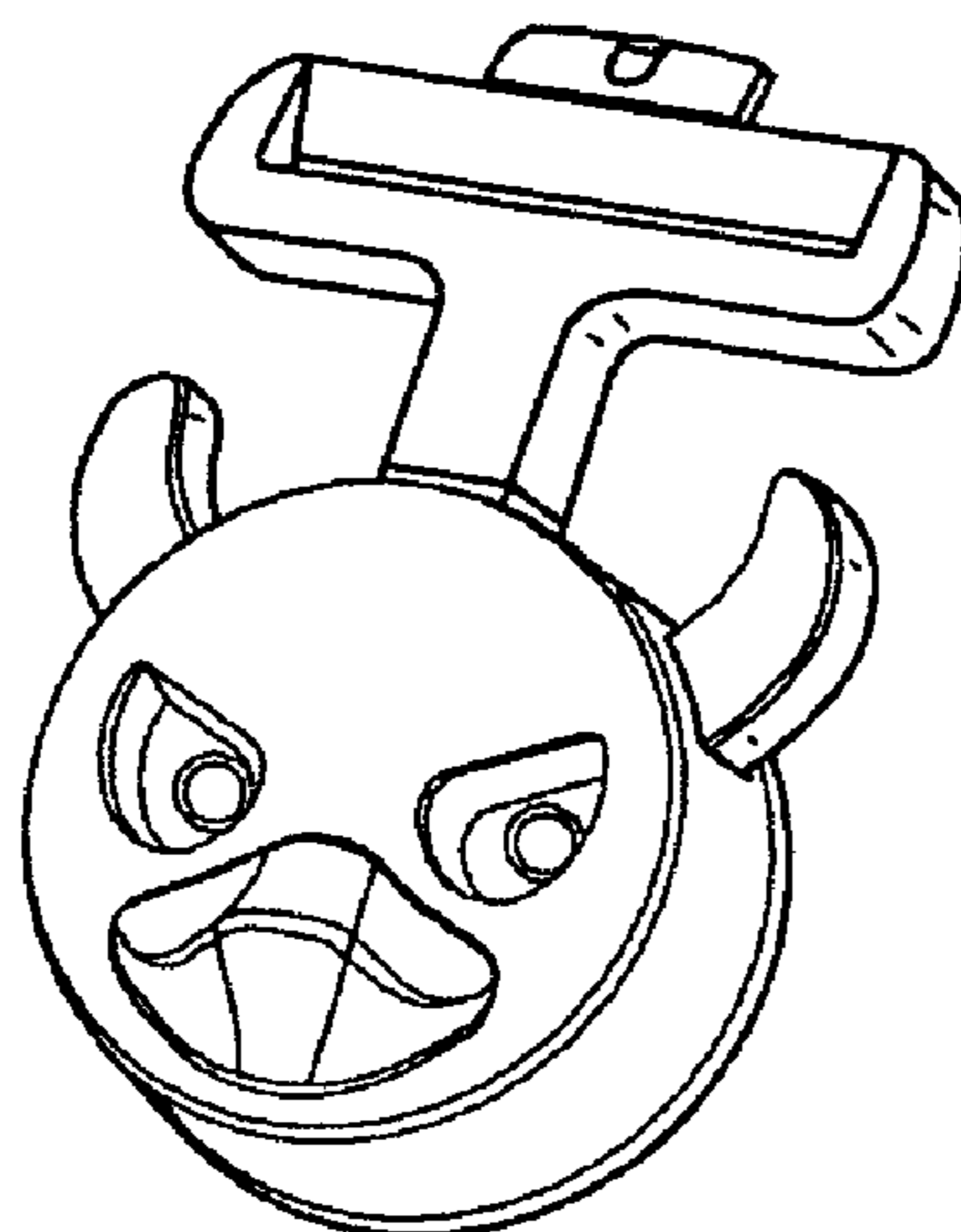

FIG. 1

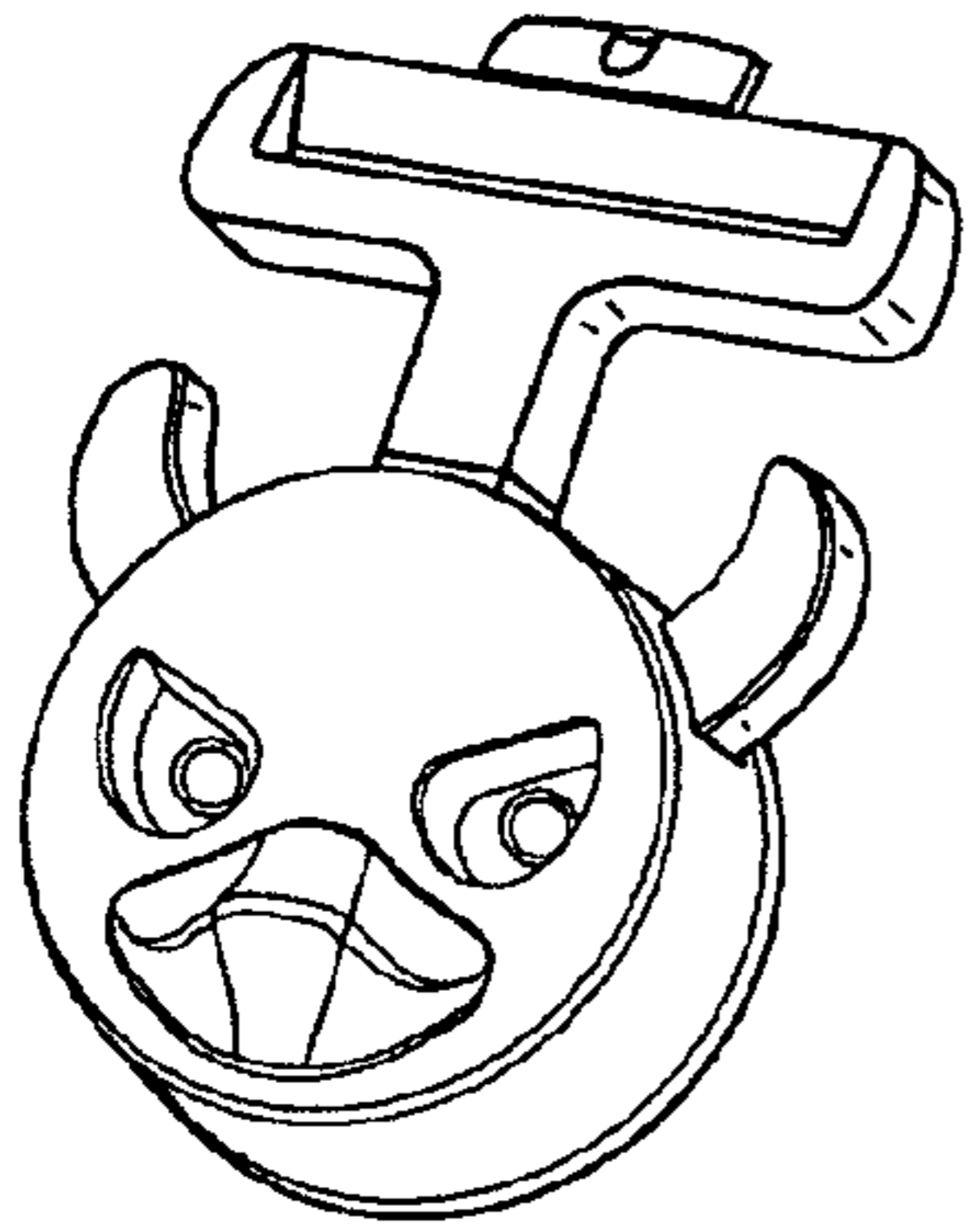

FIG. 2

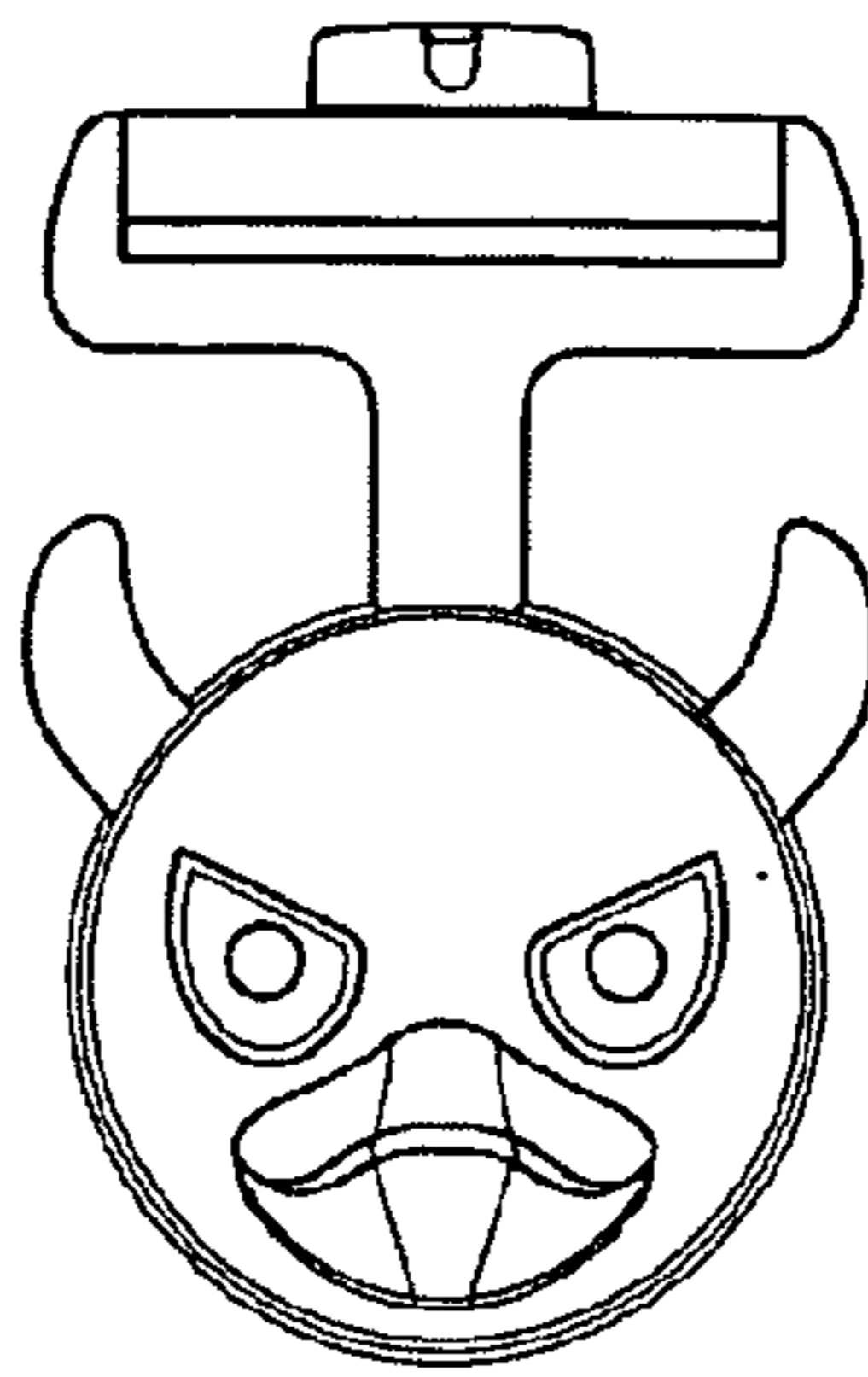

FIG. 3

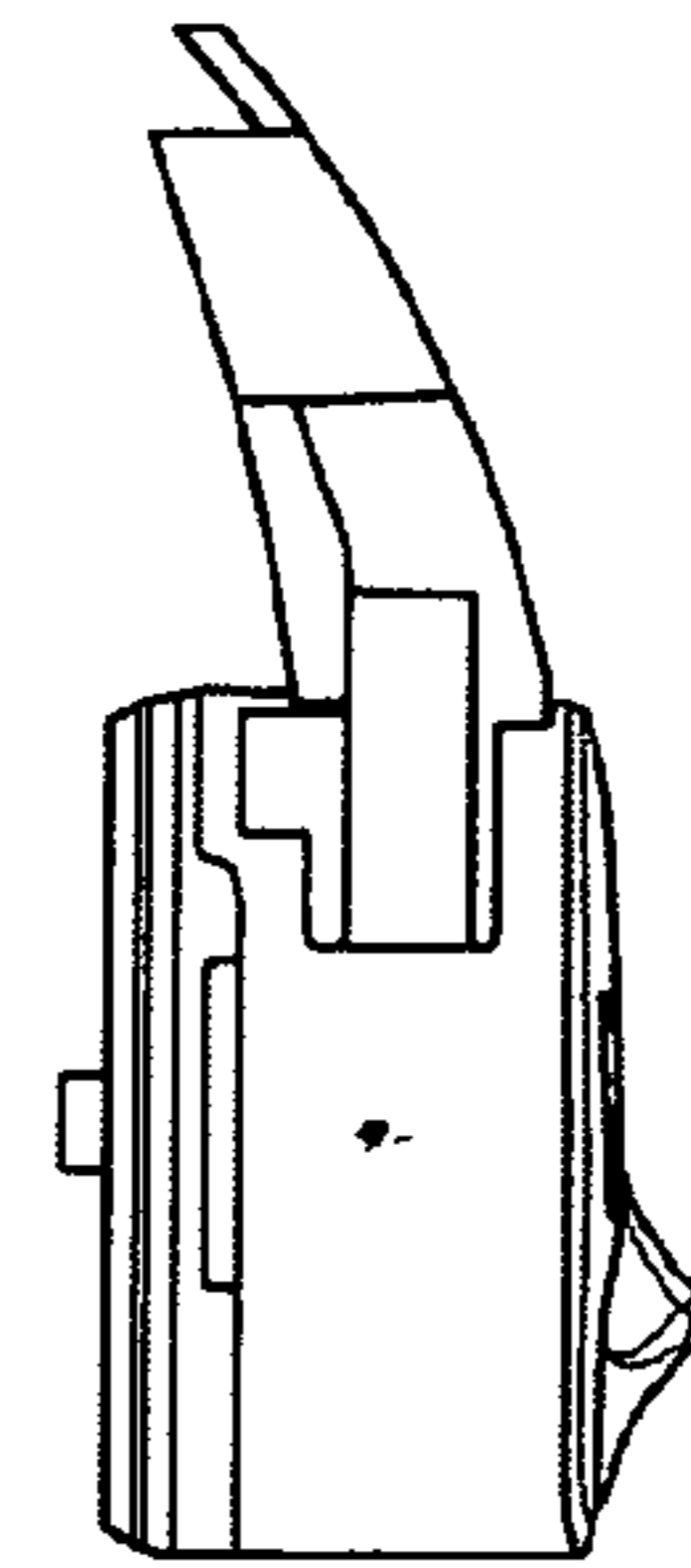

FIG. 4

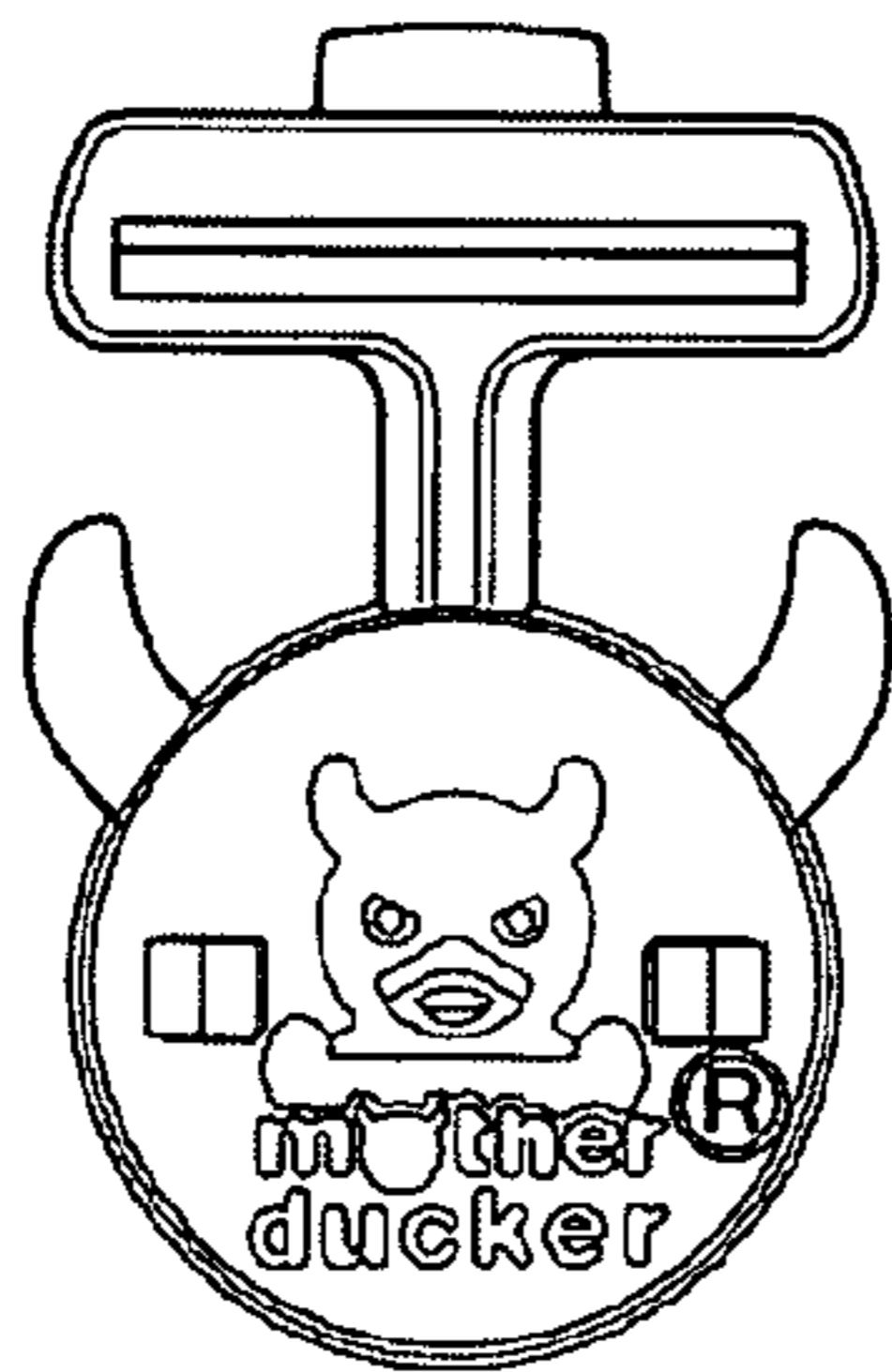

FIG. 5

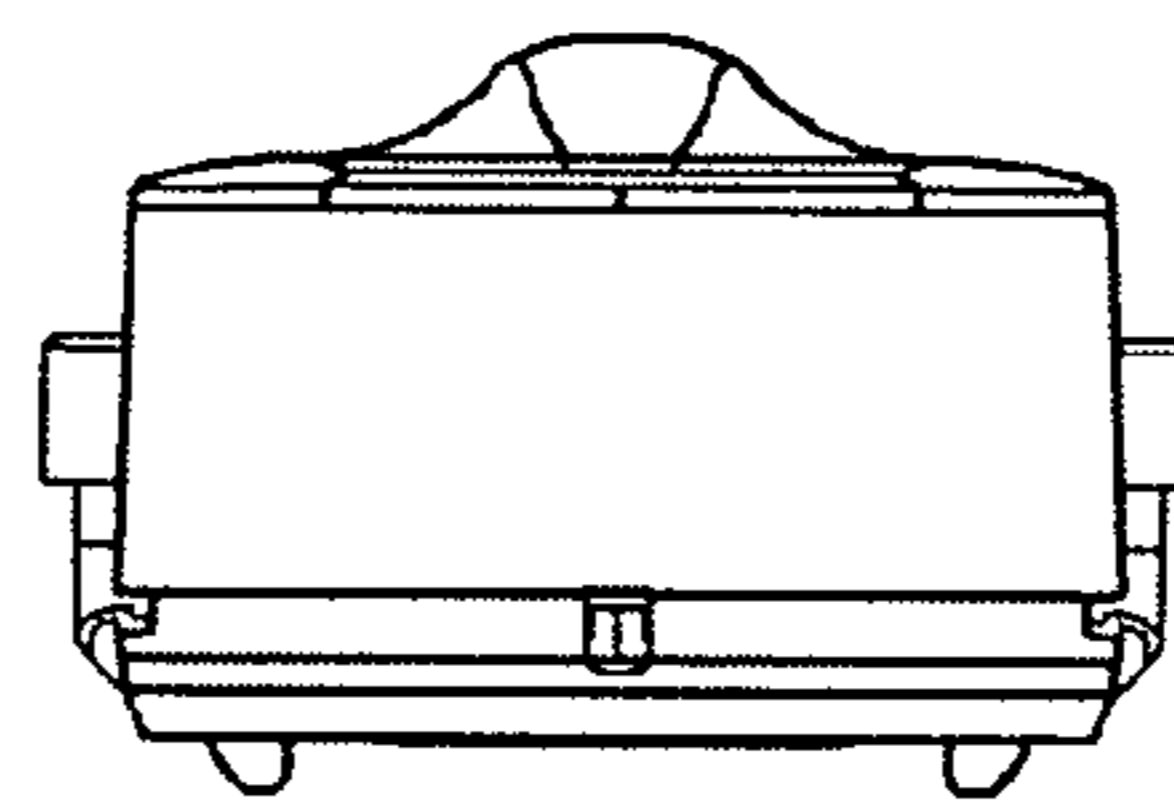

FIG. 6

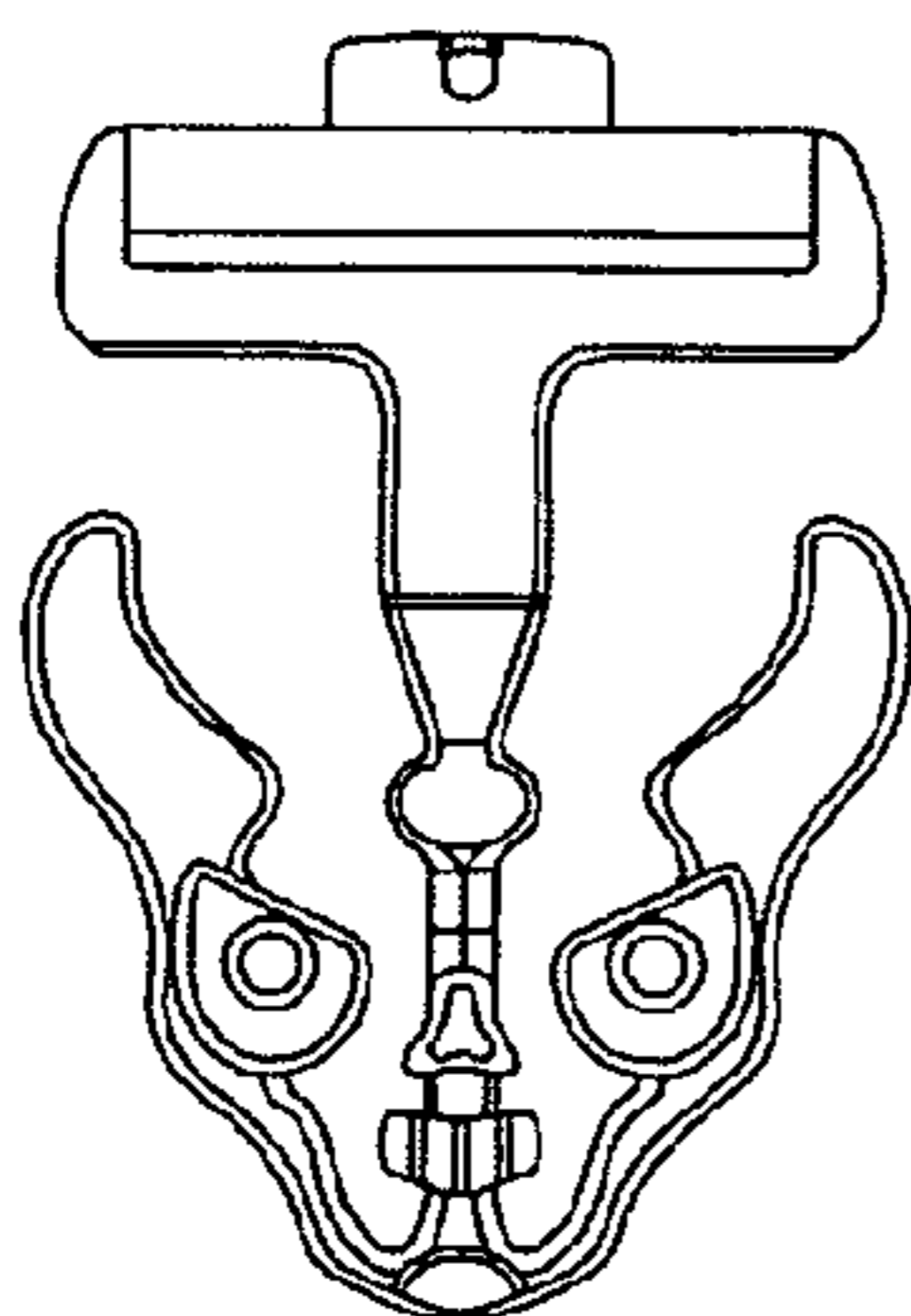

FIG. 7

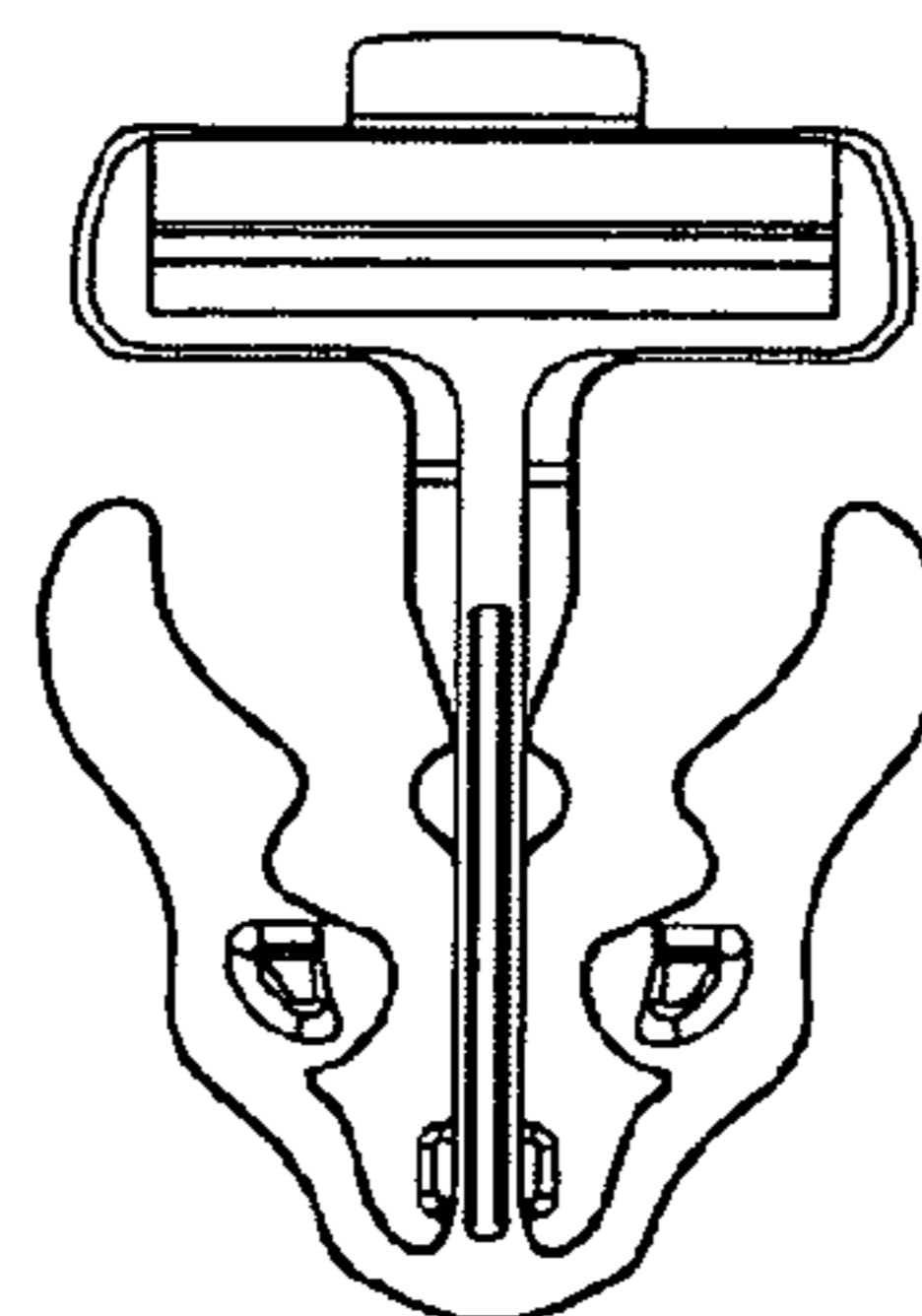

FIG. 8

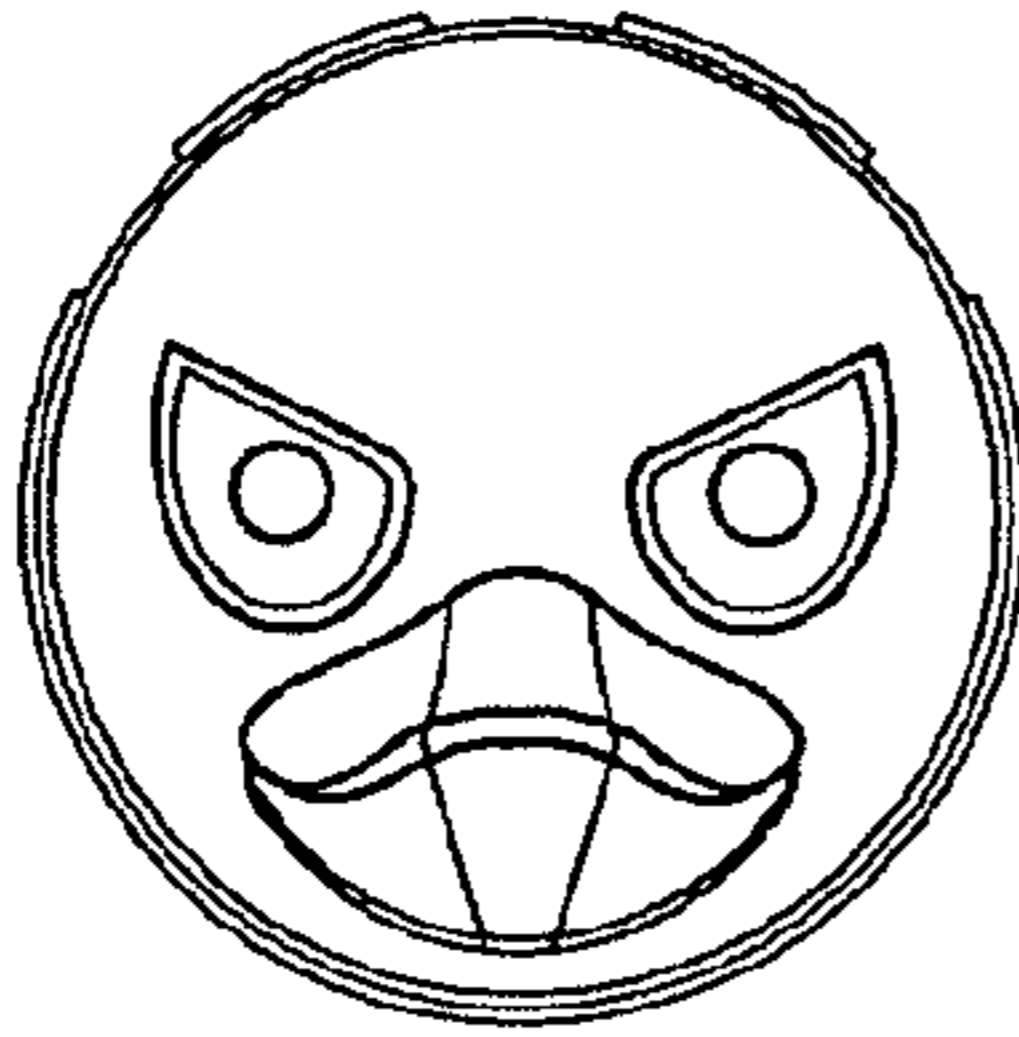

FIG. 9

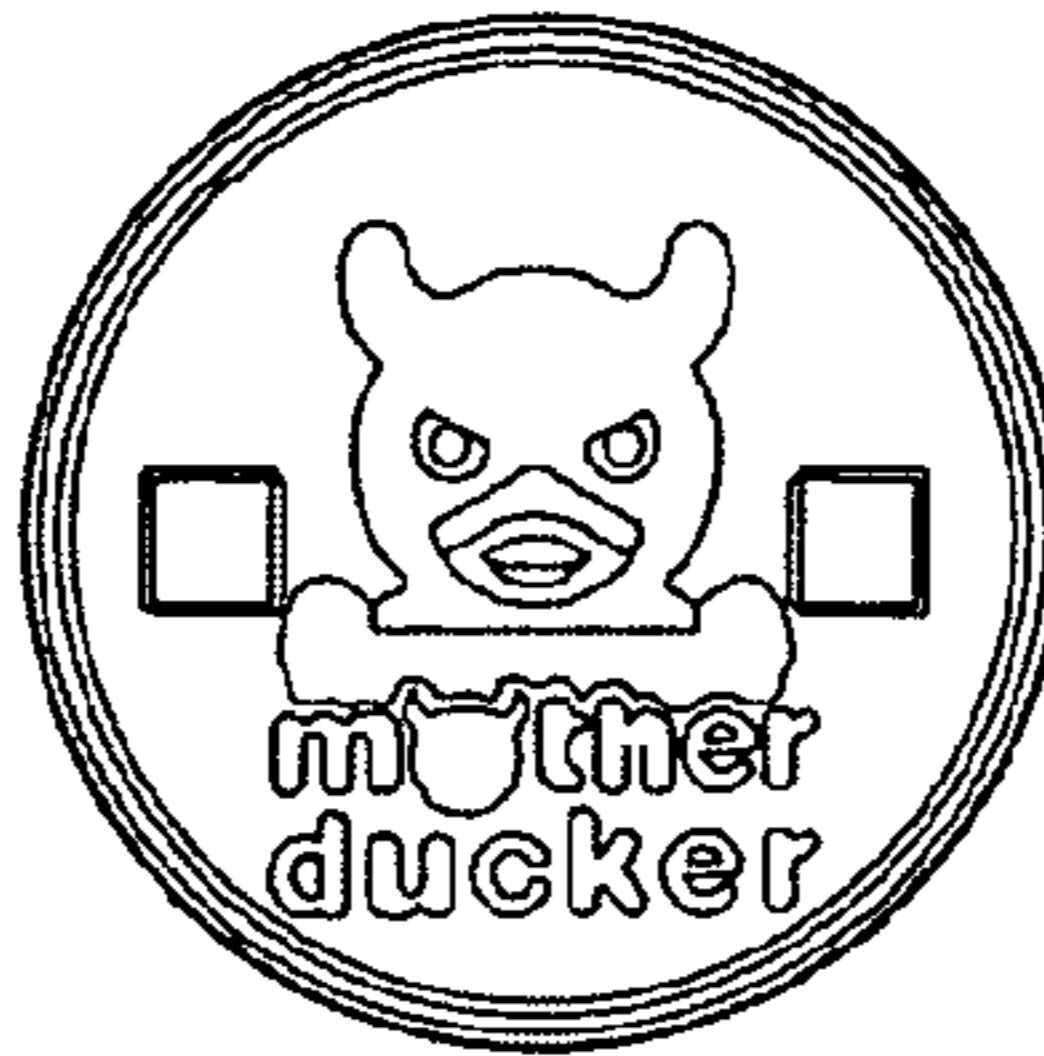

FIG. 10

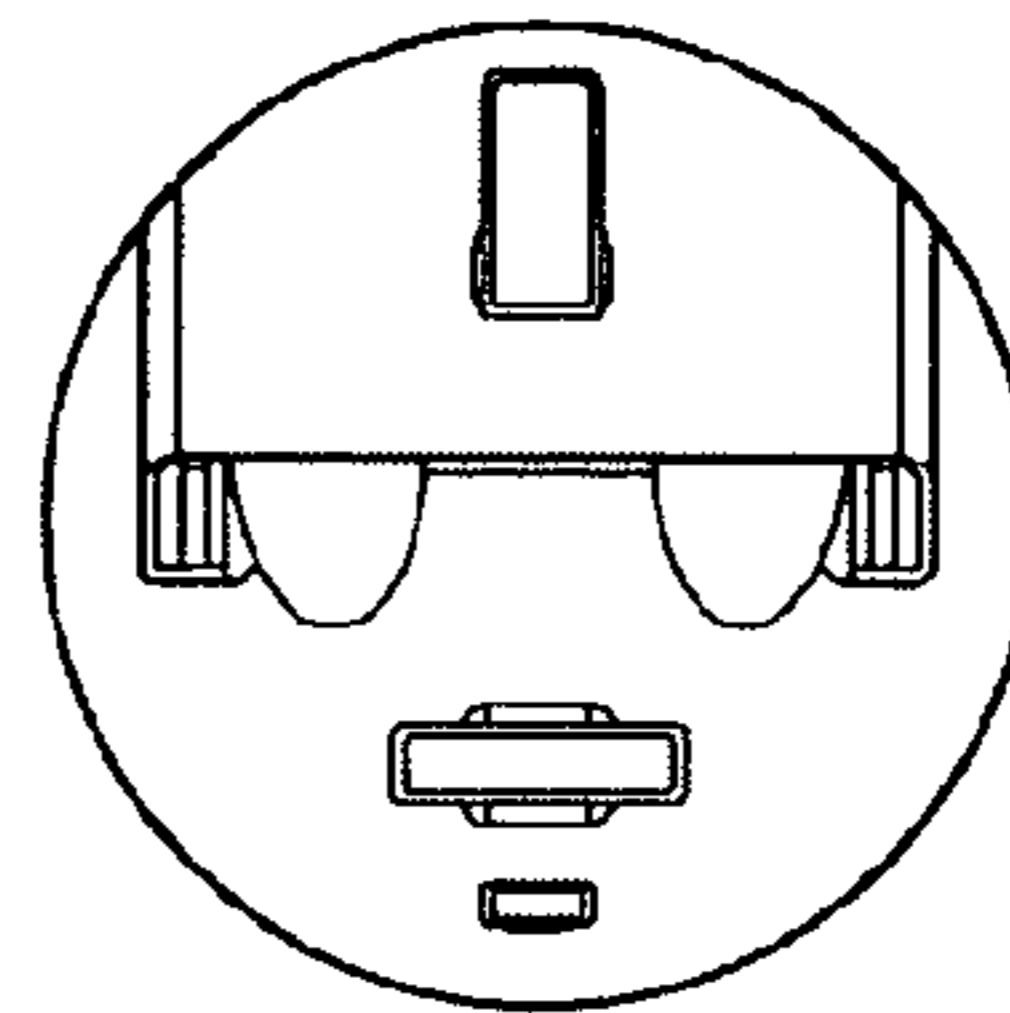

FIG. 11

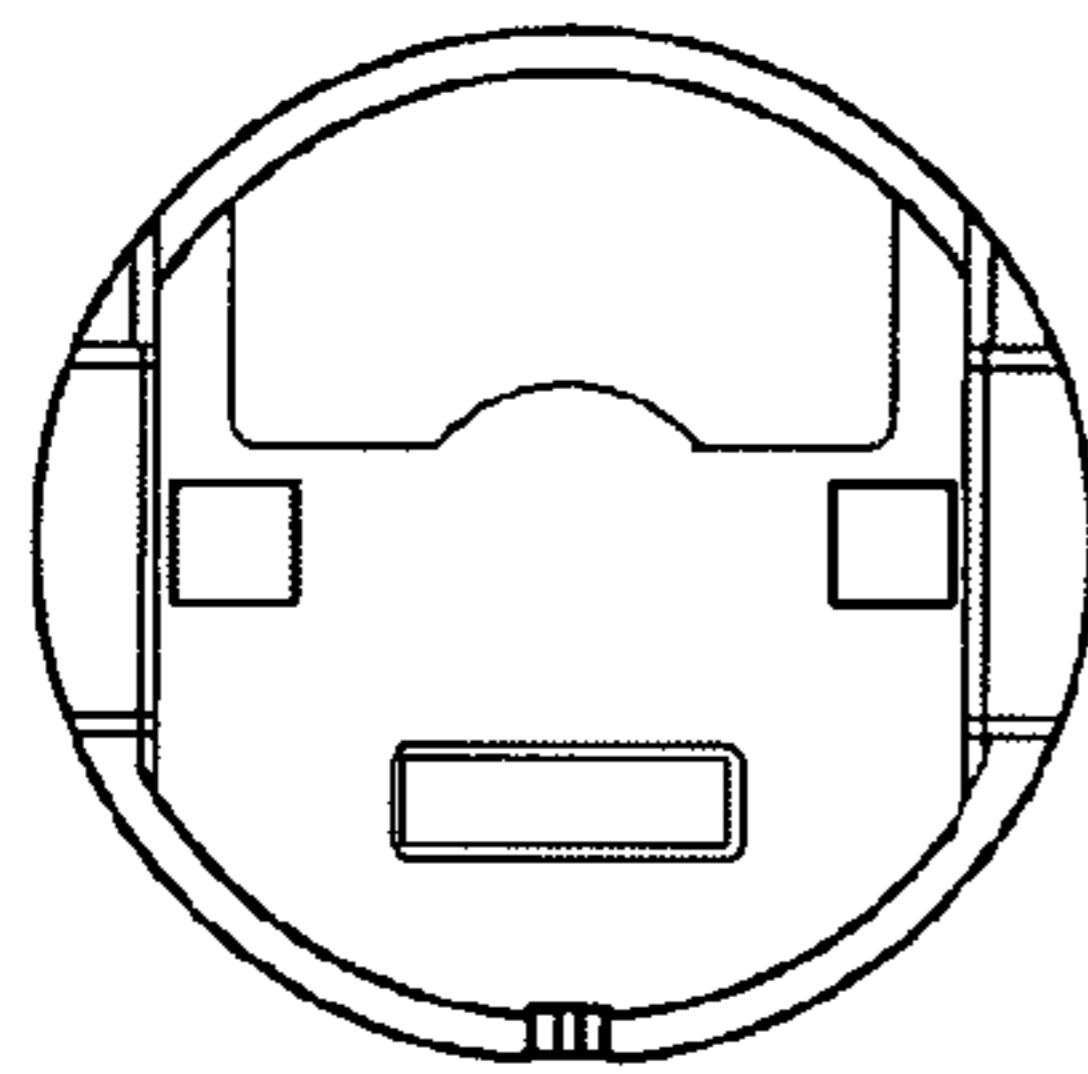

FIG. 12

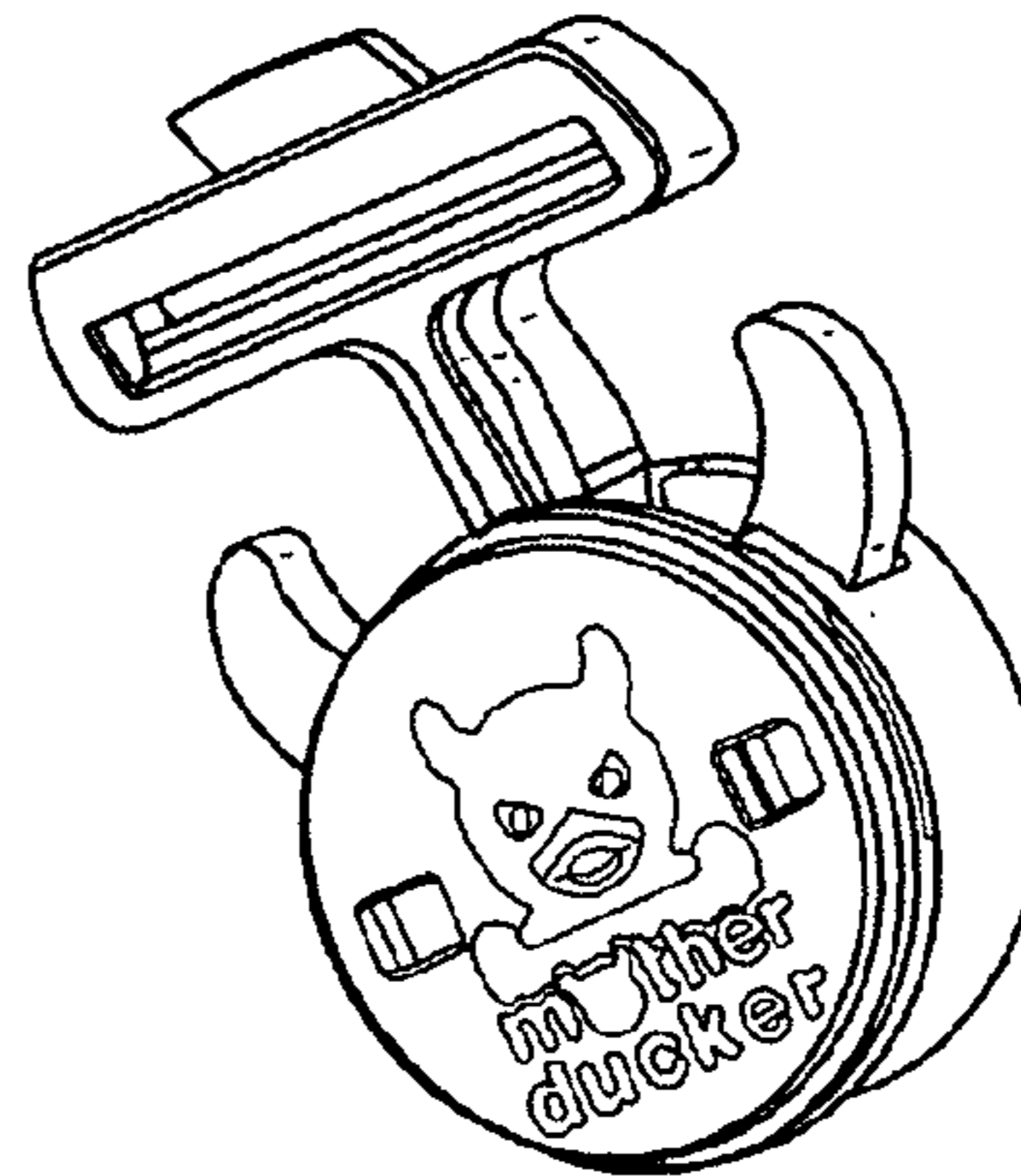

FIG. 13

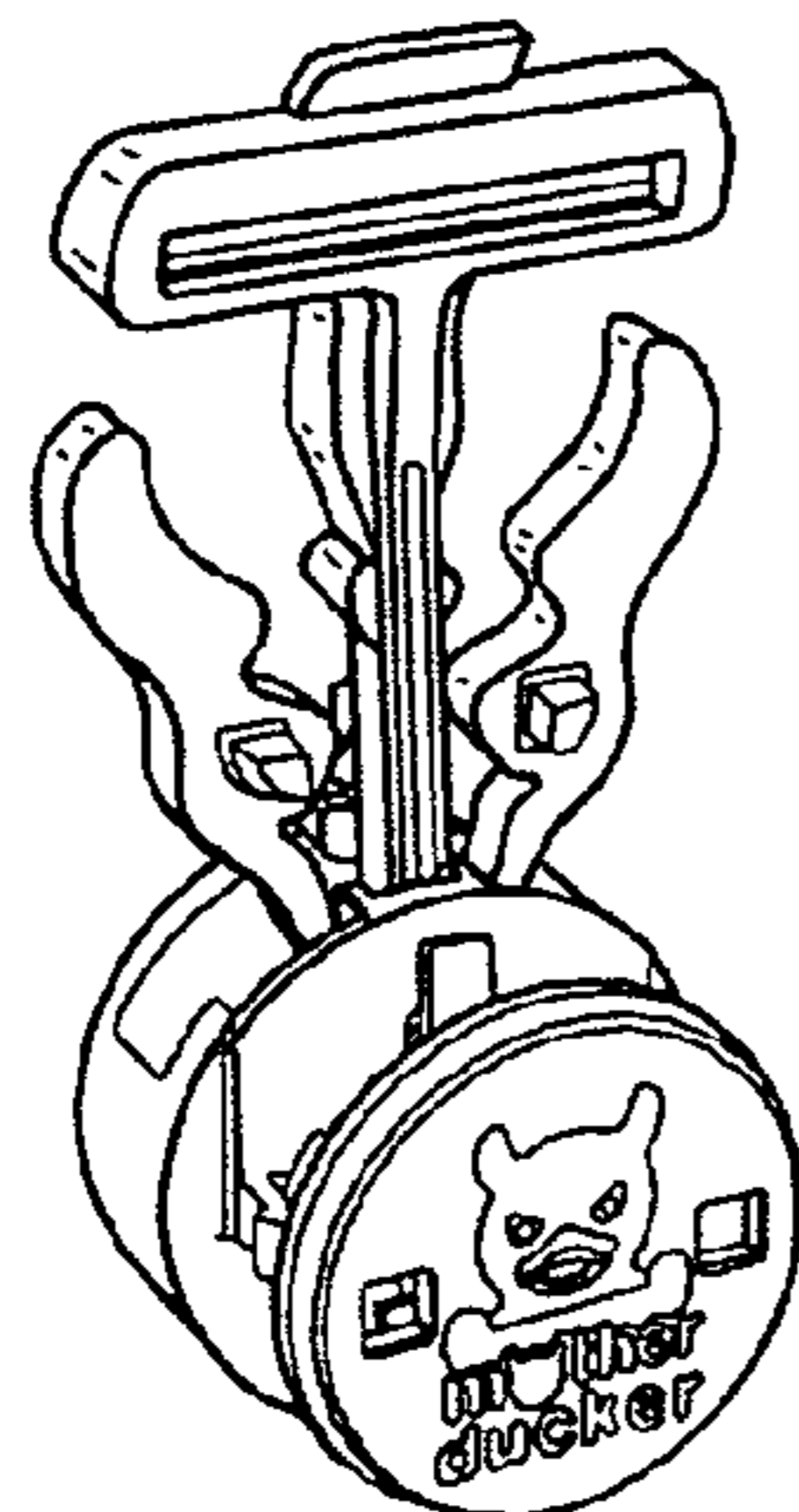

FIG. 14

