



US00D607199S

(12) **United States Design Patent**
Boyd et al.

(10) **Patent No.:** **US D607,199 S**
(45) **Date of Patent:** **** Jan. 5, 2010**

(54) **CARRYING CASE WITH BACKBONE**

(57) **CLAIM**

(75) Inventors: **Michael Boyd**, Boulder, CO (US);
Dennis Balchunas, Boulder, CO (US);
Richard N. Case, Boulder, CO (US)

The ornamental design for a carrying case with backbone, as shown and described.

(73) Assignee: **Nite Ize, Inc.**, Boulder, CO (US)

DESCRIPTION

(**) Term: **14 Years**

FIG. 1 is a right-front perspective view of a first embodiment of a carrying case with backbone;

(21) Appl. No.: **29/317,886**

FIG. 2 is a right-rear perspective of the carrying case according to FIG. 1;

(22) Filed: **May 8, 2008**

FIG. 3 is a right side view of the carrying case according to FIG. 1;

Related U.S. Application Data

(63) Continuation-in-part of application No. 12/043,600, filed on Mar. 6, 2008.

FIG. 4 is a left side view of the carrying case according to FIG. 1;

(51) **LOC (9) Cl.** **03-01**

FIG. 5 is a front view of the carrying case according to FIG. 1;

(52) **U.S. Cl.** **D3/218**

FIG. 6 is a rear view of the carrying case according to FIG. 1;

(58) **Field of Classification Search** D3/218,
D3/201, 215, 226, 219, 263–268, 272–273,
D3/276, 289, 301; 224/240–241, 245, 581,
224/583, 676–681, 646, 908–909; 206/316.1,
206/316.2; D6/407, 631–633

FIG. 7 is a top view of the carrying case according to FIG. 1;
FIG. 8 is a bottom view of the carrying case according to FIG. 1;

See application file for complete search history.

FIG. 9 is a right-front perspective view of a second embodiment of a carrying case with backbone;

(56) **References Cited**

FIG. 10 is a right-rear perspective of the carrying case according to FIG. 9;

U.S. PATENT DOCUMENTS

D379,262	S *	5/1997	Seigel	D3/218
5,964,386	A	10/1999	Cote		
D418,287	S *	1/2000	Moor	D3/201
6,056,174	A	5/2000	Minckler		
D429,563	S *	8/2000	Kurano et al.	D3/226
6,370,401	B1	4/2002	Baranowski et al.		
D482,526	S *	11/2003	Fair	D3/267
6,659,320	B1 *	12/2003	Alves et al.	224/581
6,915,934	B2	7/2005	Hassett		
D532,199	S	11/2006	Balchunas et al.		
D539,031	S	3/2007	Balchunas et al.		

FIG. 11 is a right side view of the carrying case according to FIG. 9;

FIG. 12 is a left side view of the carrying case according to FIG. 9;

FIG. 13 is a front view of the carrying case according to FIG. 9;

FIG. 14 is a rear view of the carrying case according to FIG. 9;

FIG. 15 is a top view of the carrying case according to FIG. 9; and,

FIG. 16 is a bottom view of the carrying case according to FIG. 9.

(Continued)

Primary Examiner—Catherine R Oliver
(74) *Attorney, Agent, or Firm*—Patton Boggs LLP

1 Claim, 8 Drawing Sheets



US D607,199 S

Page 2

U.S. PATENT DOCUMENTS

D543,029 S	*	5/2007	Zapata	D3/267	D550,955 S	9/2007	Boyd et al.
D546,556 S	*	7/2007	Aaron et al.	D3/218	2004/0085694 A1	5/2004	Germagian et al.
D549,958 S		9/2007	Boyd et al.		2005/0023186 A1	2/2005	Hassett
D550,954 S		9/2007	Boyd et al.		2006/0058081 A1	3/2006	Reichenbach

* cited by examiner



FIG. 1

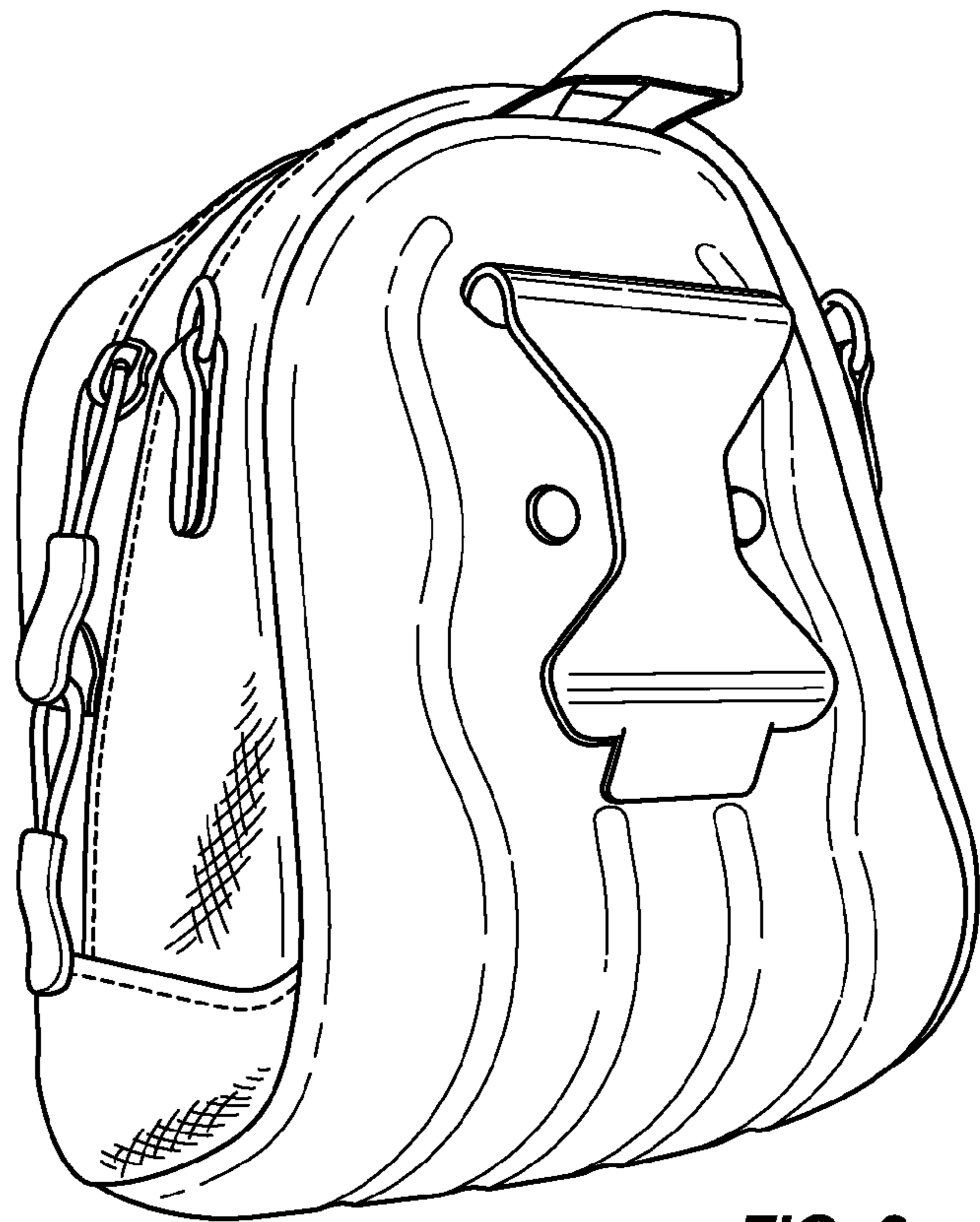

FIG. 2

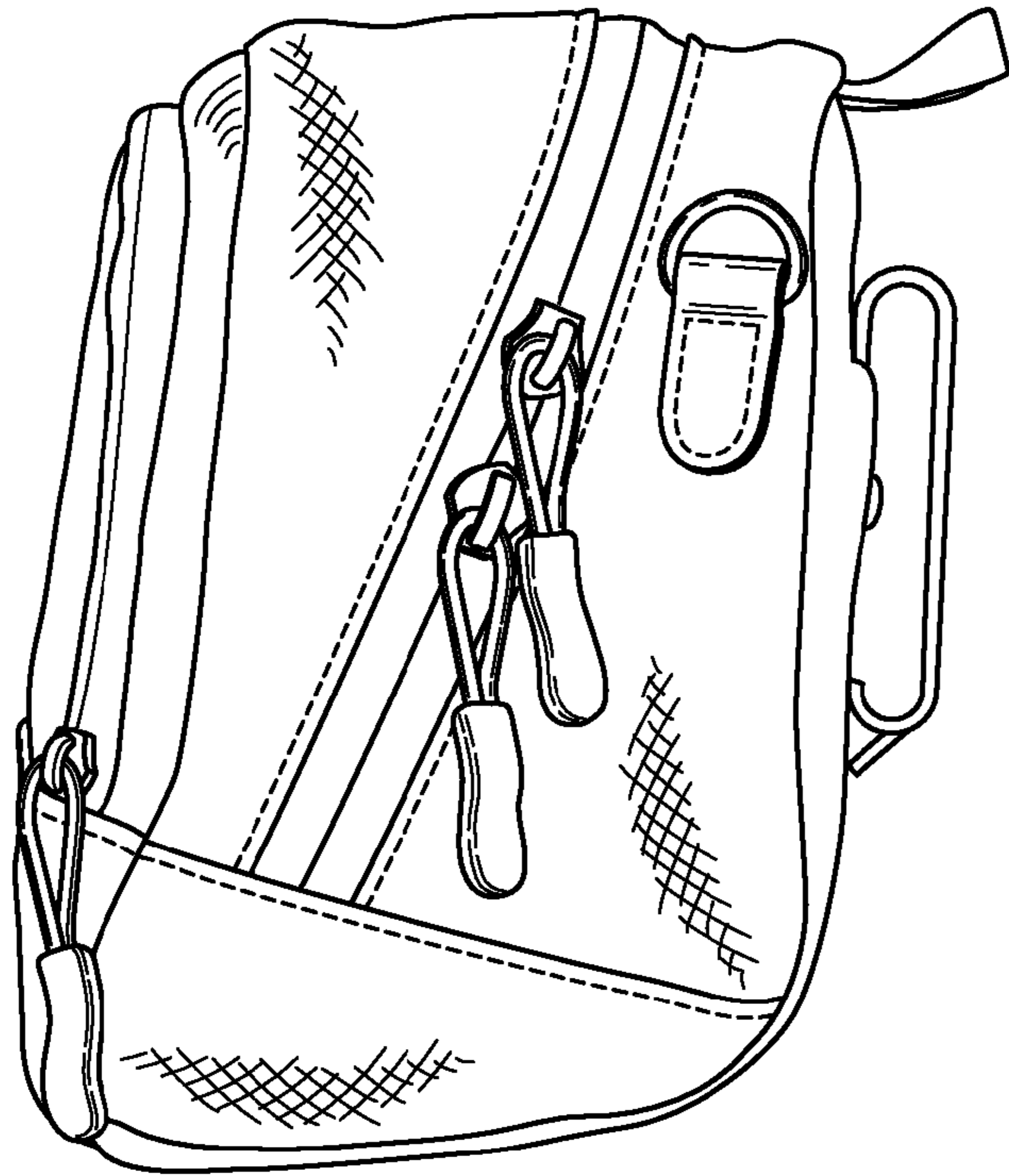

FIG. 3



FIG. 4

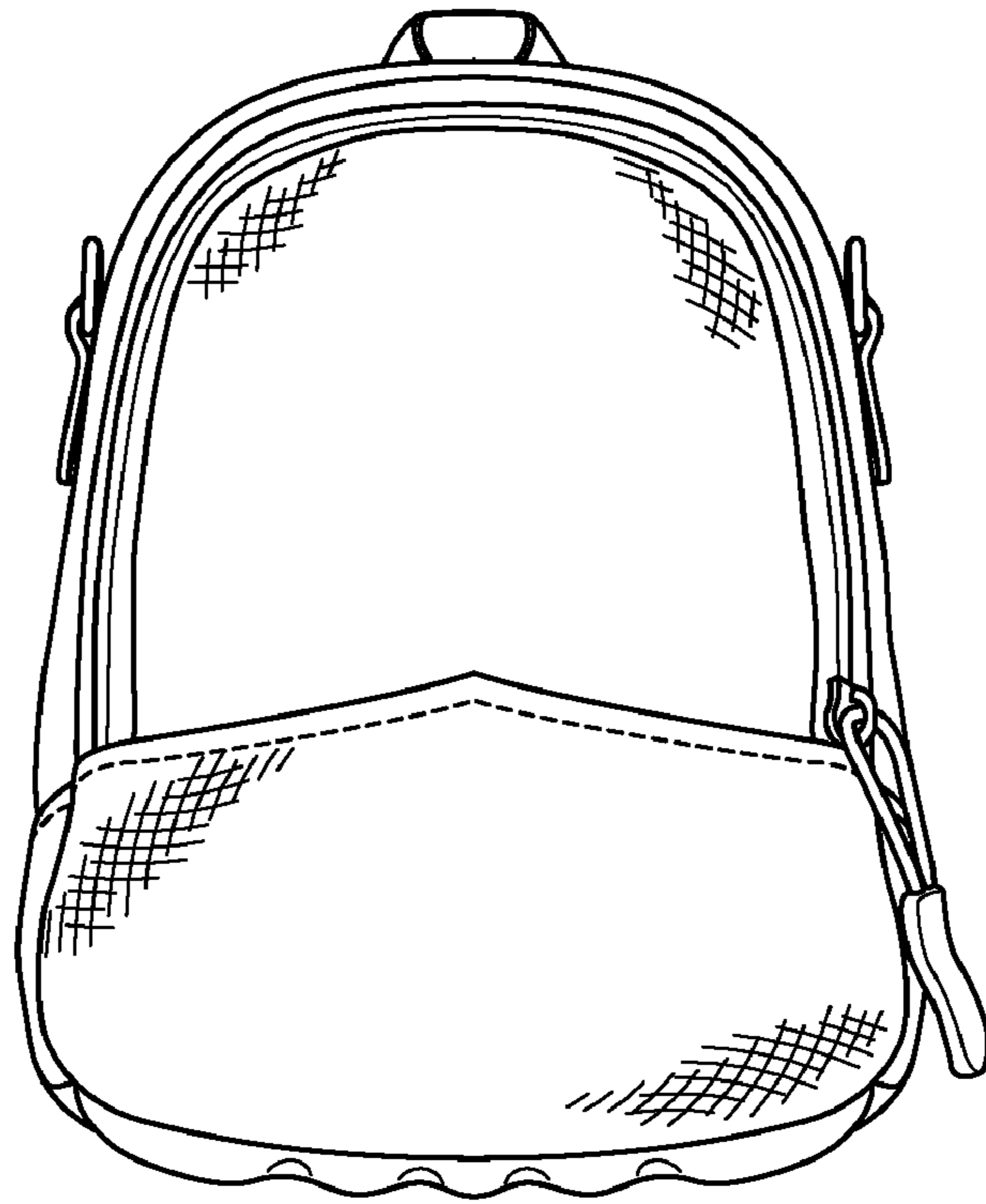

FIG. 5

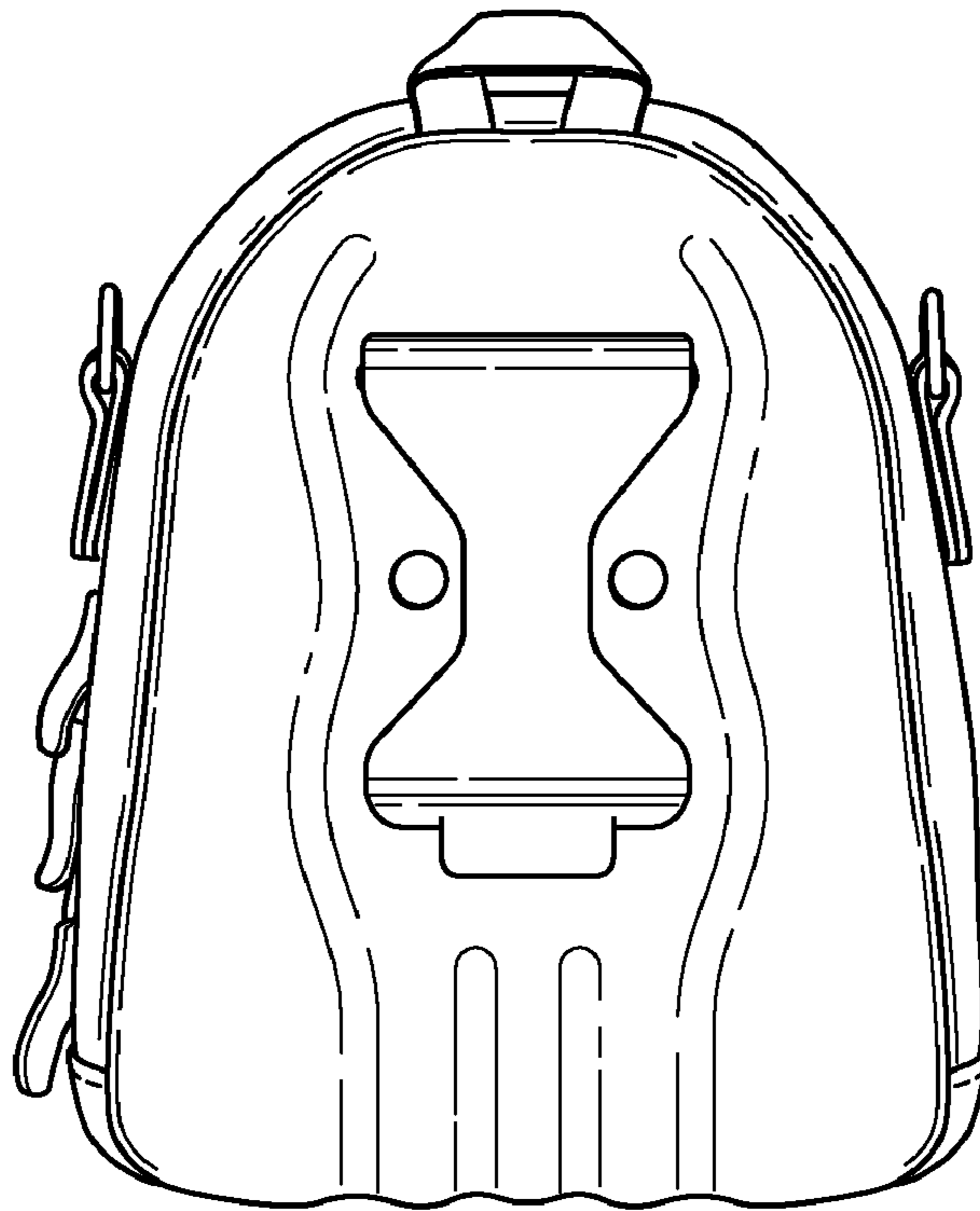

FIG. 6

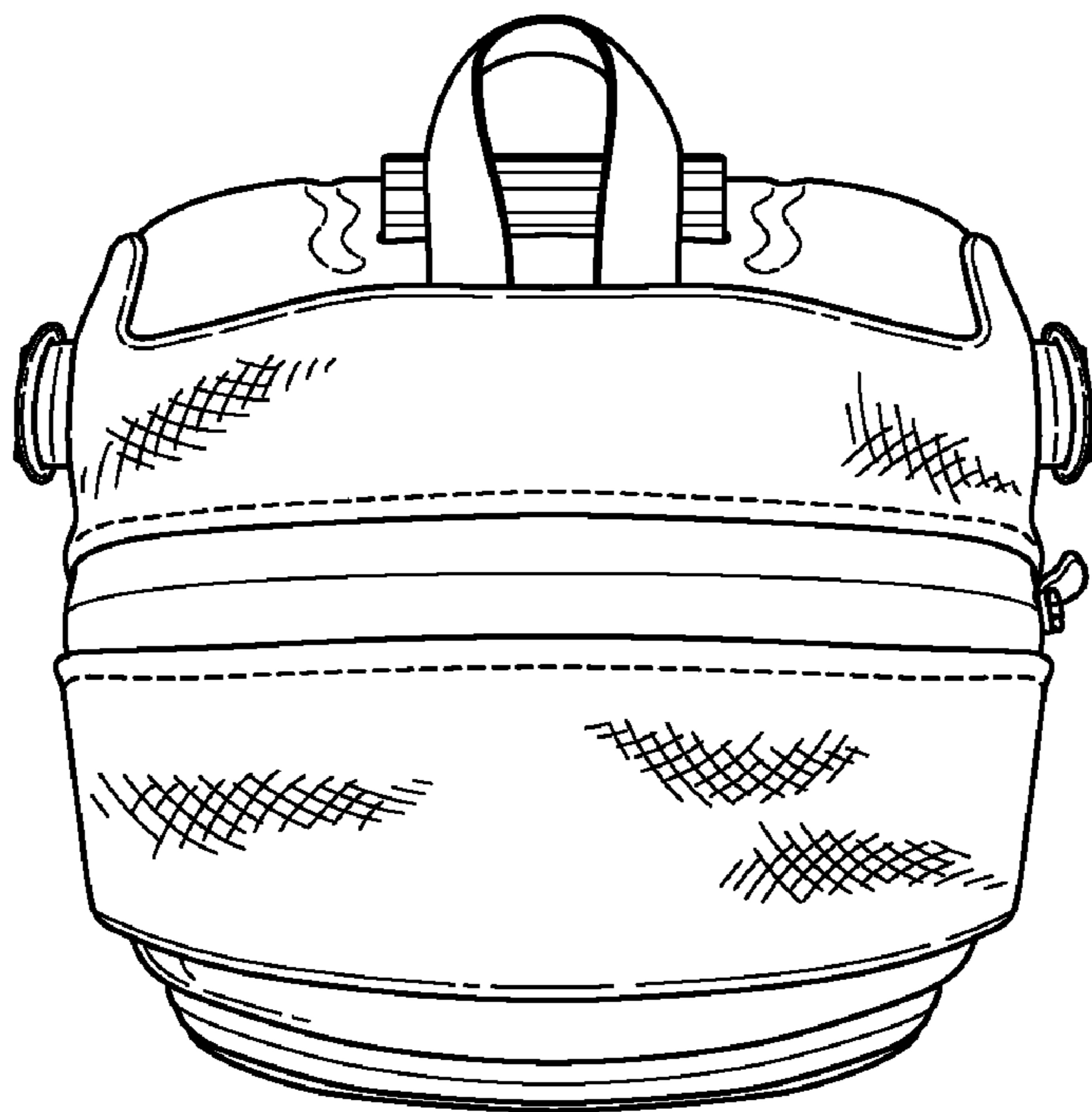

FIG. 7

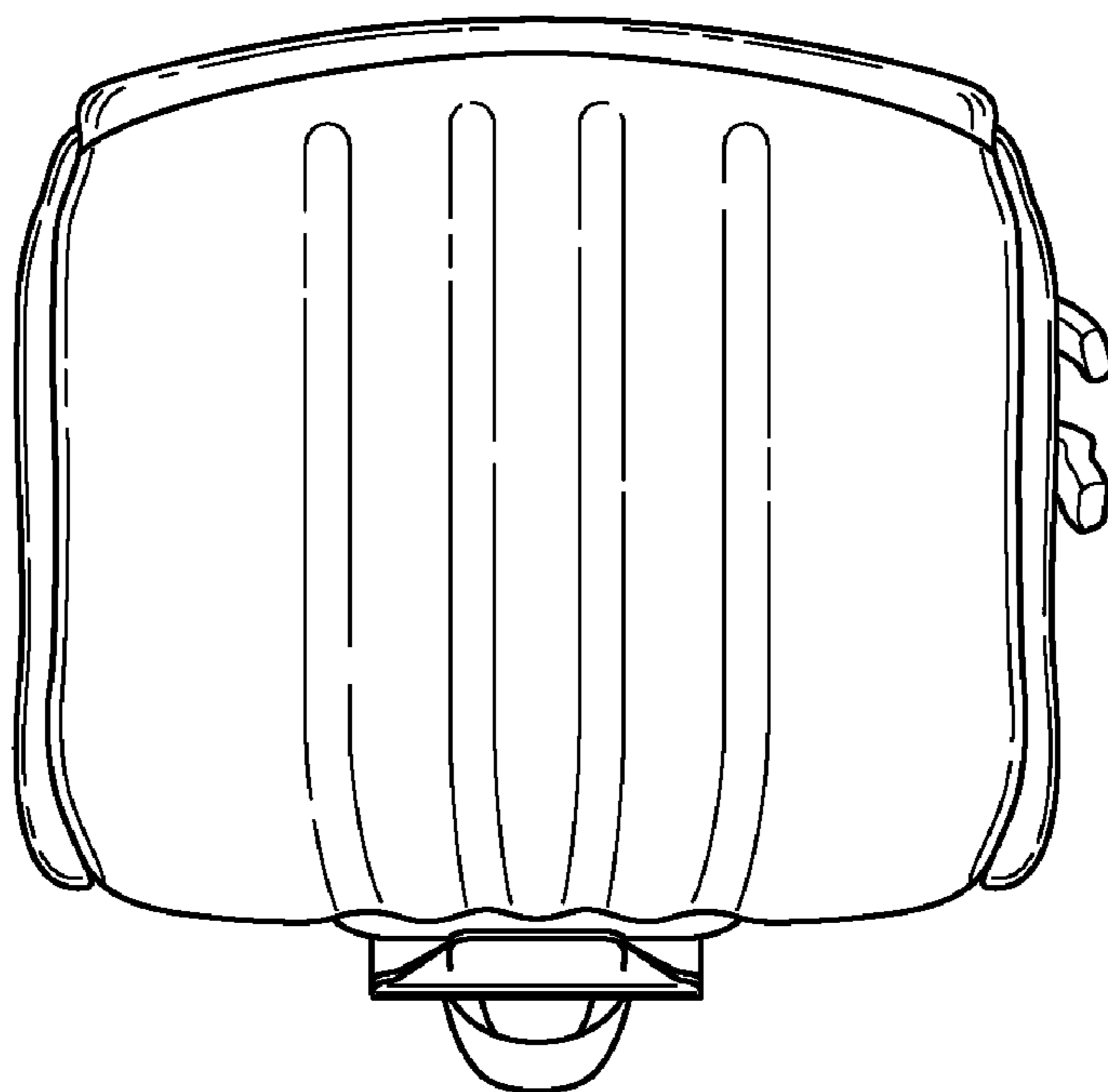

FIG. 8

FIG. 9

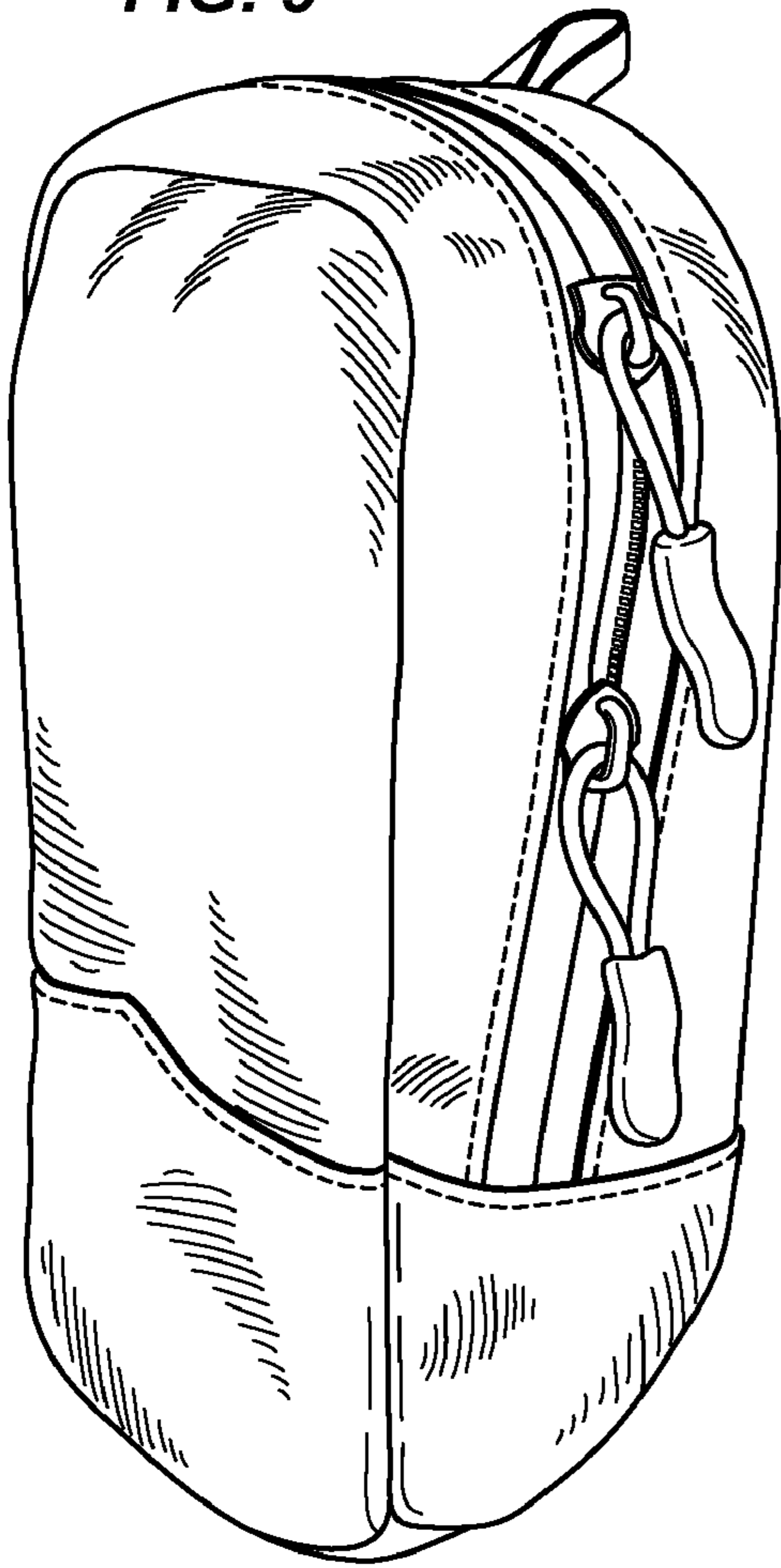
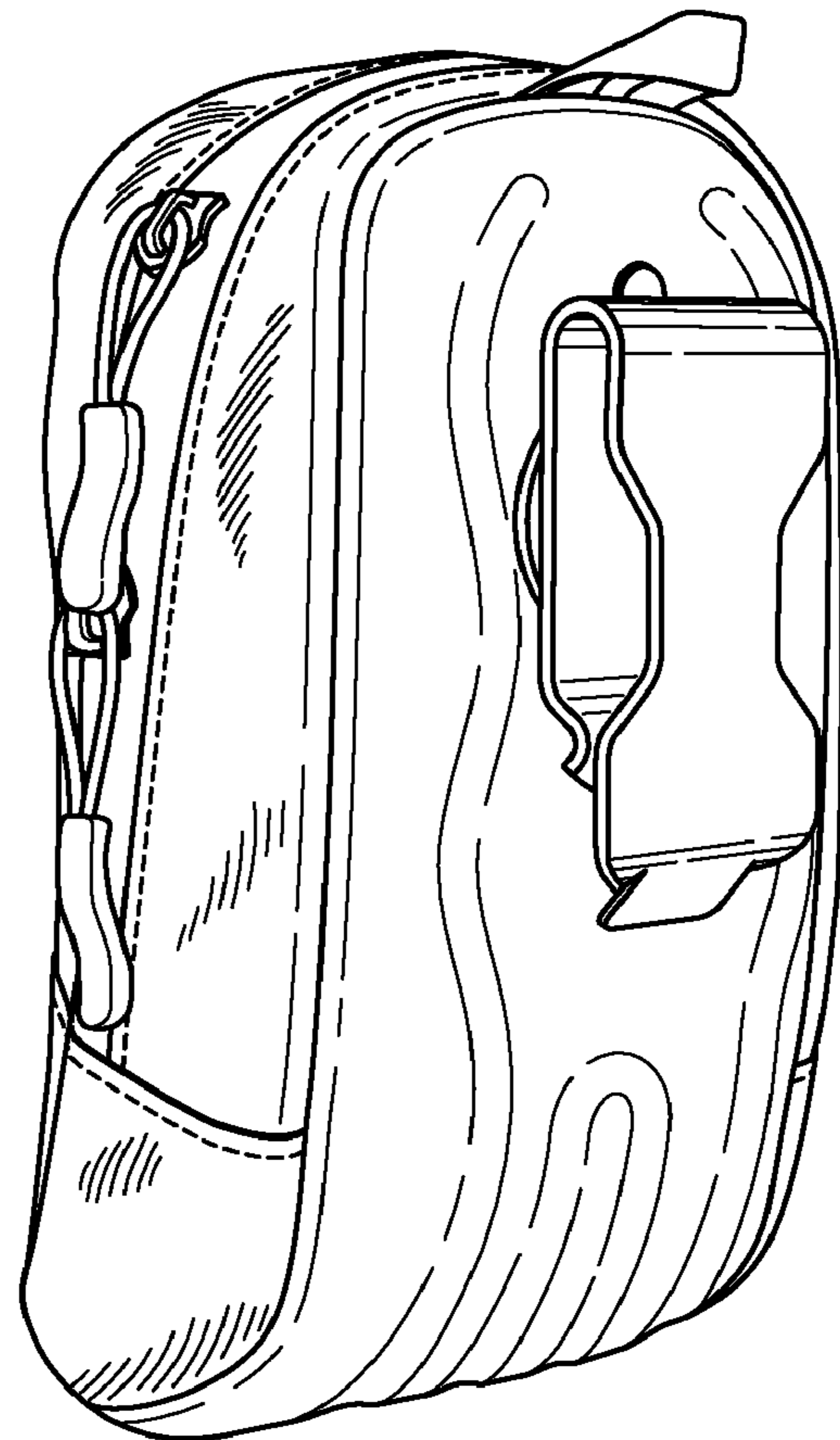

FIG. 10



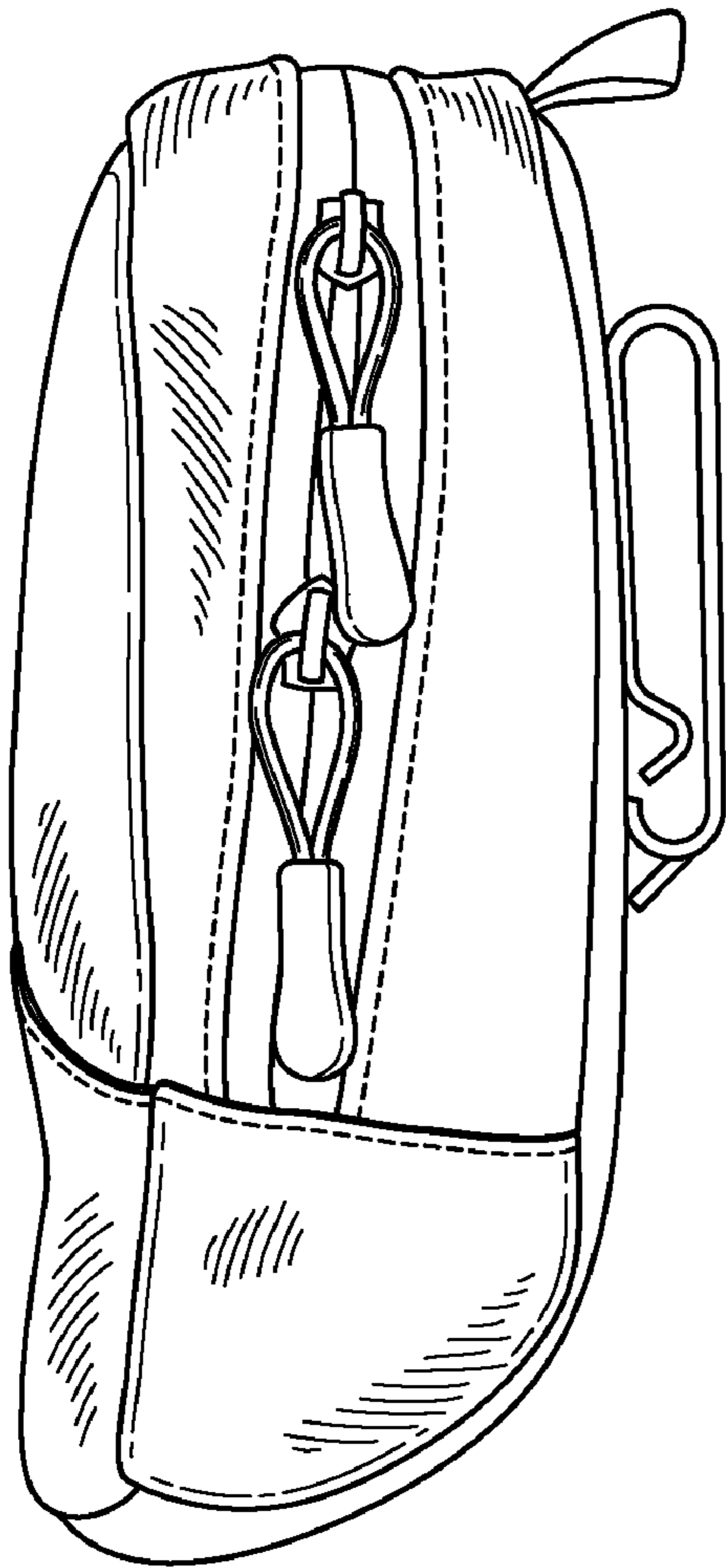

FIG. 11

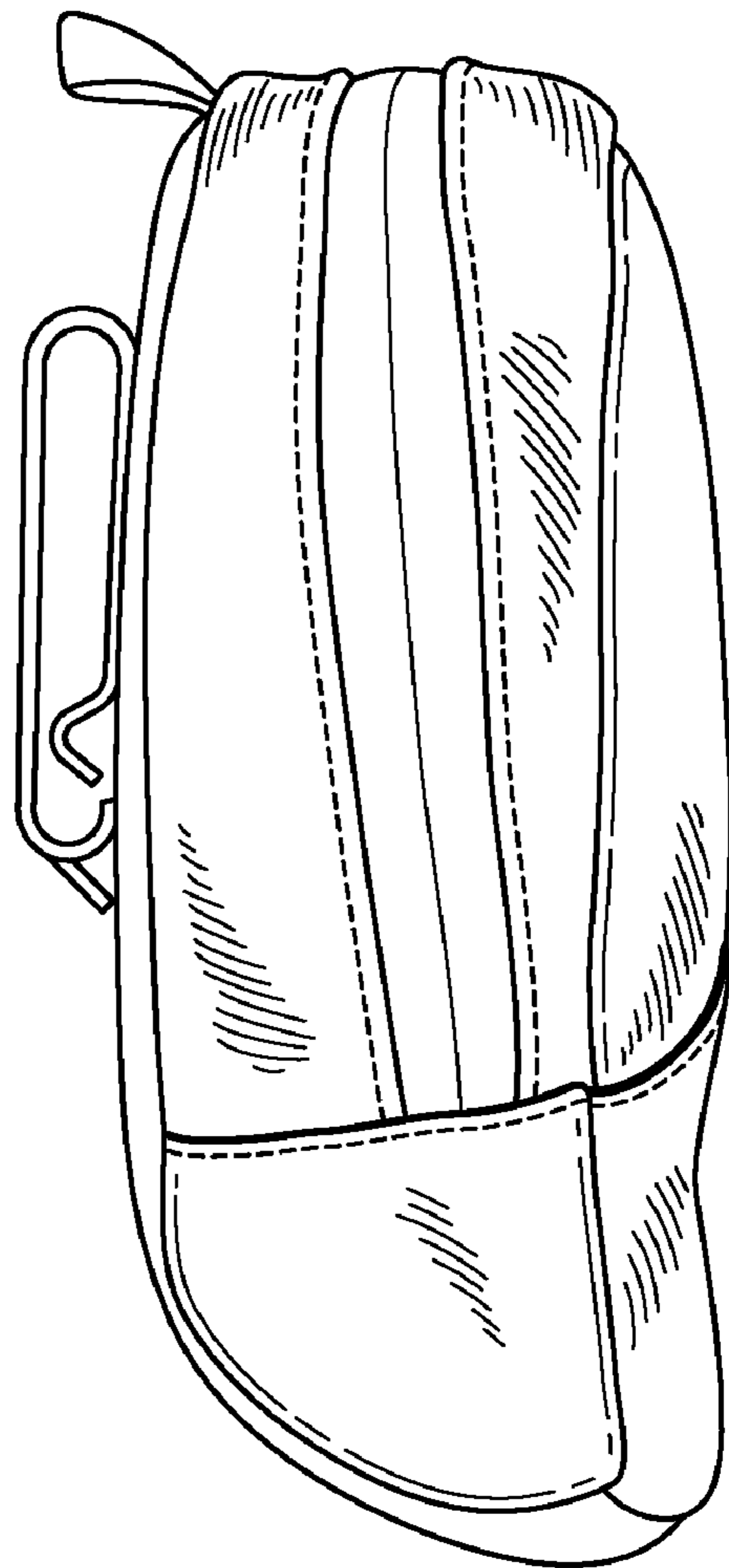

FIG. 12

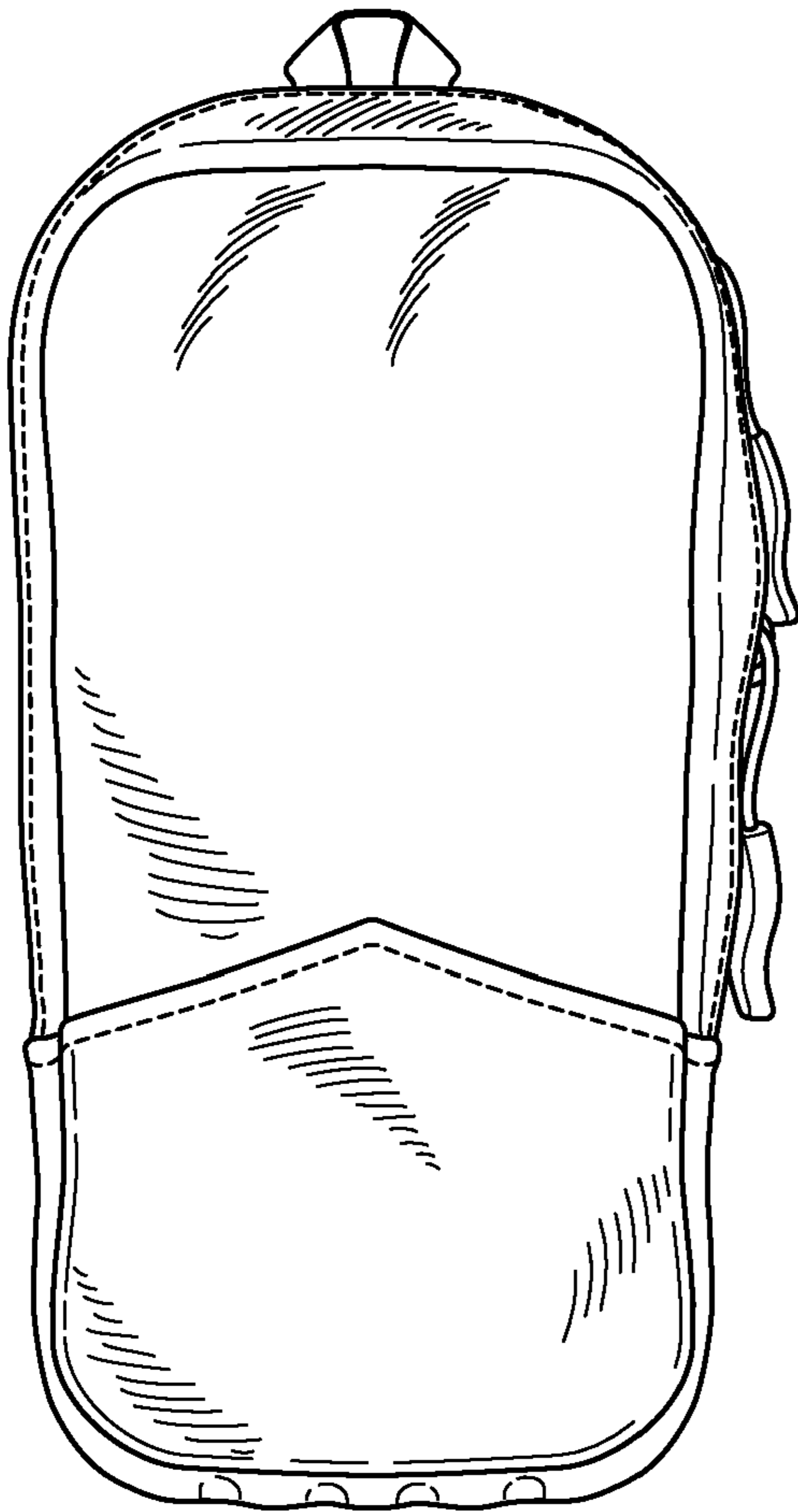

FIG. 13

FIG. 14

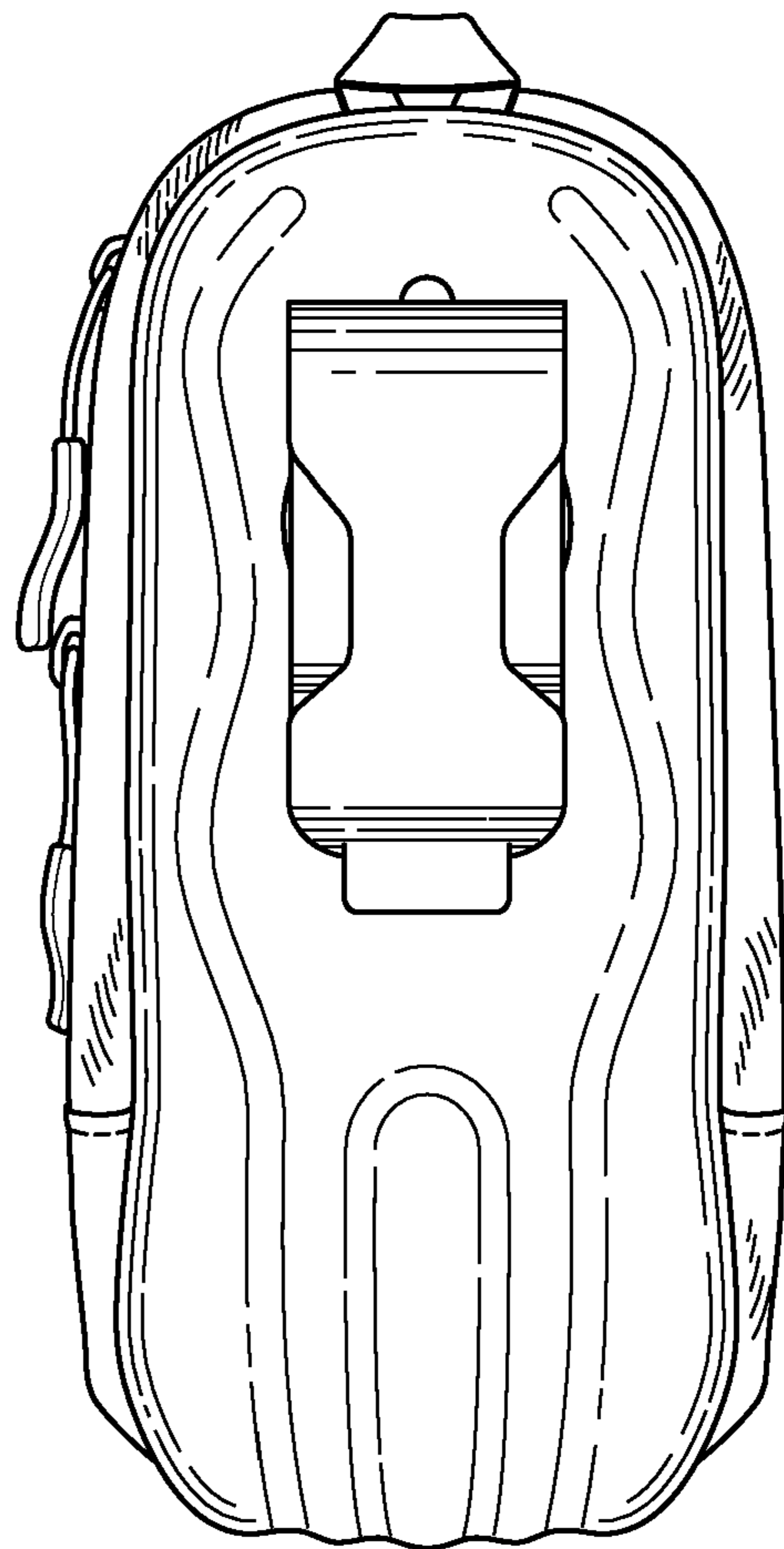

FIG. 15

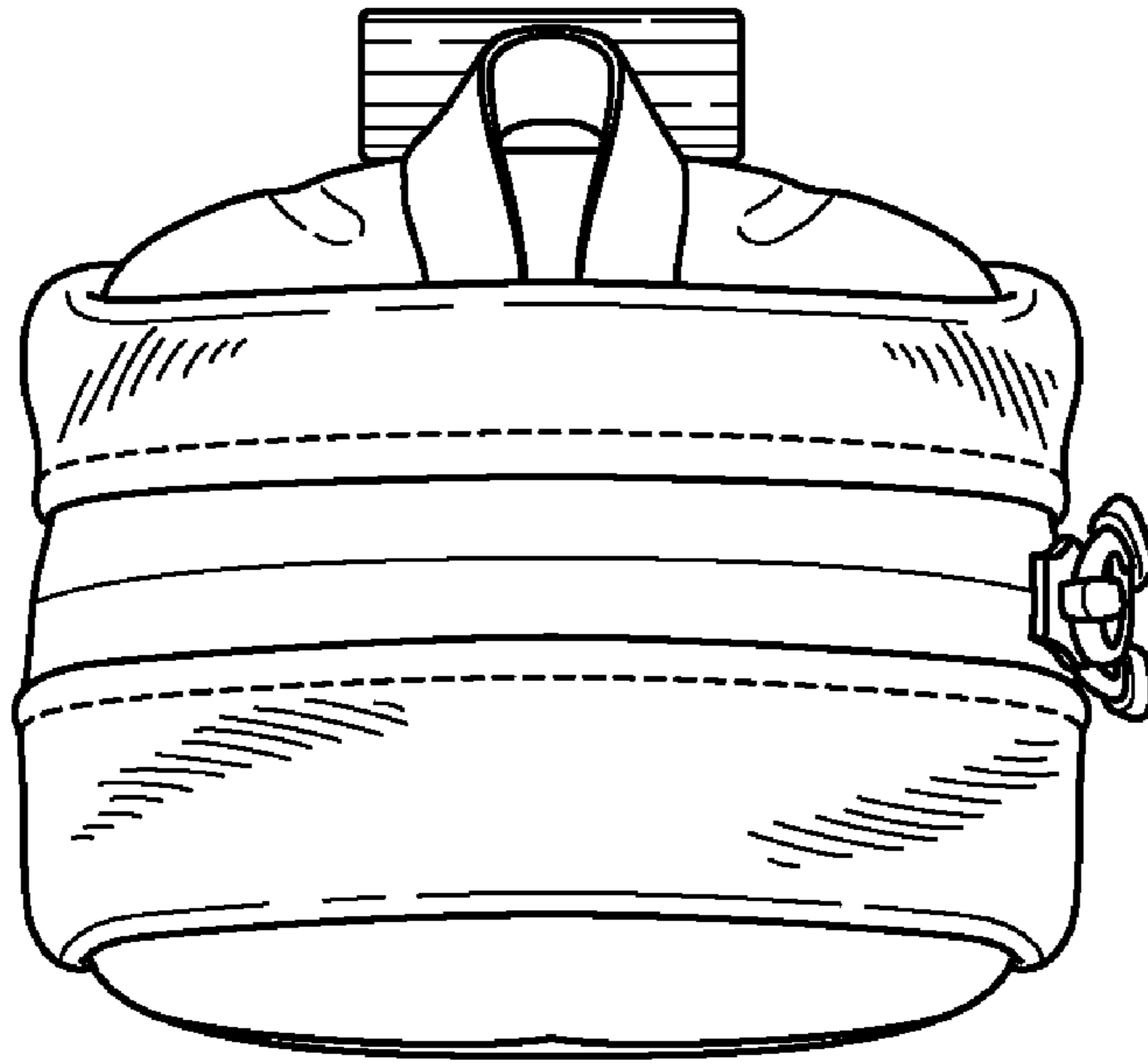

FIG. 16

