



US00D607149S

(12) **United States Design Patent**
Psimadas et al.

(10) **Patent No.:** **US D607,149 S**

(45) **Date of Patent:** **** Dec. 29, 2009**

(54) **PART OF A RAZOR HANDLE**

(75) Inventors: **Ioannis Marios Psimadas**, Vrillissia (GR); **Ioannis Bozikis**, Koukaki (GR); **Spiros Gratsias**, Kypseli (GR)

(73) Assignee: **Societe BIC**, Clichy Cedex (FR)

(**) Term: **14 Years**

(21) Appl. No.: **29/326,180**

(22) Filed: **Oct. 14, 2008**

(30) **Foreign Application Priority Data**

Apr. 15, 2008 (EM) 000916598

(51) **LOC (9) Cl.** **28-03**

(52) **U.S. Cl.** **D28/47**

(58) **Field of Classification Search** 30/32, 30/34.05, 34.1, 34.2, 41-41.8, 44-45, 47-51, 30/53-58, 526-533, 537, 77-83, 538; D28/44.1-48
See application file for complete search history.

(56) **References Cited**

U.S. PATENT DOCUMENTS

D491,311 S * 6/2004 Follo D28/48
D537,207 S * 2/2007 Wonderley et al. D28/51

D566,896 S * 4/2008 Jung D28/46
D568,539 S * 5/2008 Micinilio et al. D28/53
D586,954 S * 2/2009 Micinilio D28/47
D591,451 S * 4/2009 Micinilio et al. D28/46

* cited by examiner

Primary Examiner—Jennifer Rivard

(74) *Attorney, Agent, or Firm*—The H. T. Than Law Grou

(57) **CLAIM**

The ornamental design for a part of a razor handle, as shown and described.

DESCRIPTION

FIG. 1 is a perspective view of a part of a razor handle showing our new design;

FIG. 2 is a top elevational view thereof;

FIG. 3 is a bottom elevational view thereof;

FIG. 4 is a left side view thereof;

FIG. 5 is a right side view thereof;

FIG. 6 is a front view thereof; and,

FIG. 7 is a rear end view thereof.

The broken lines are for illustration purposes only and form no part of the claimed design.

1 Claim, 2 Drawing Sheets

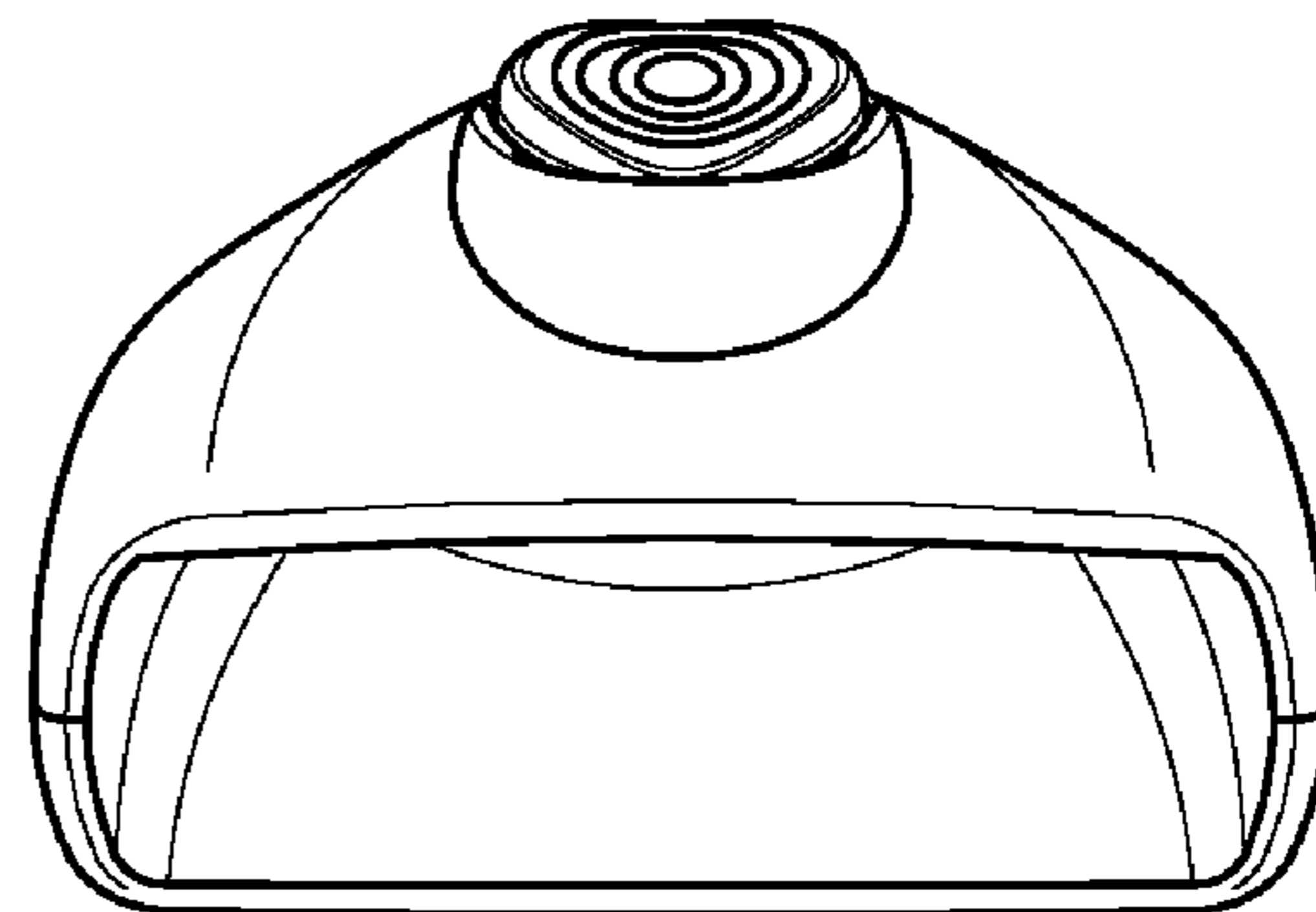
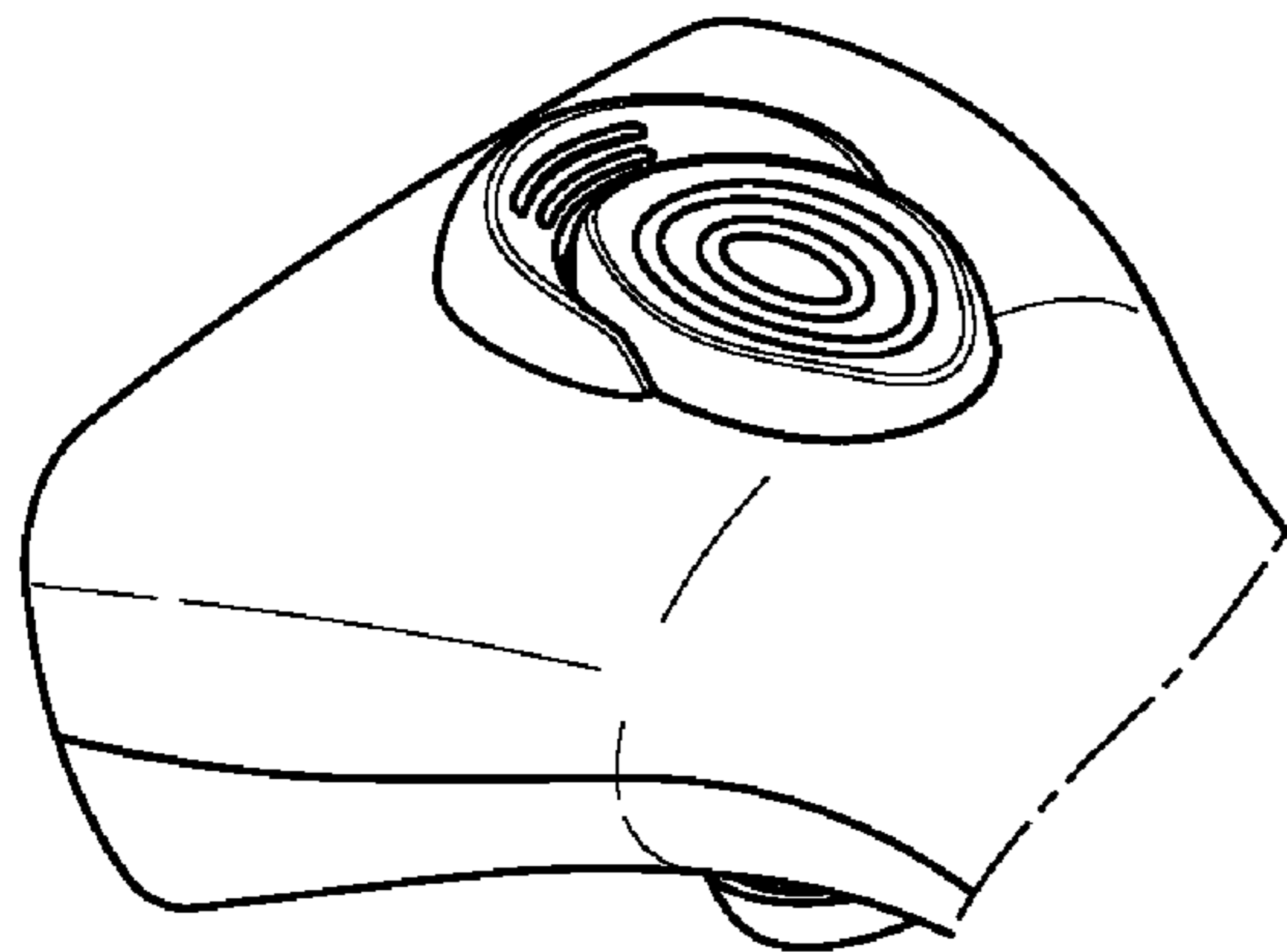

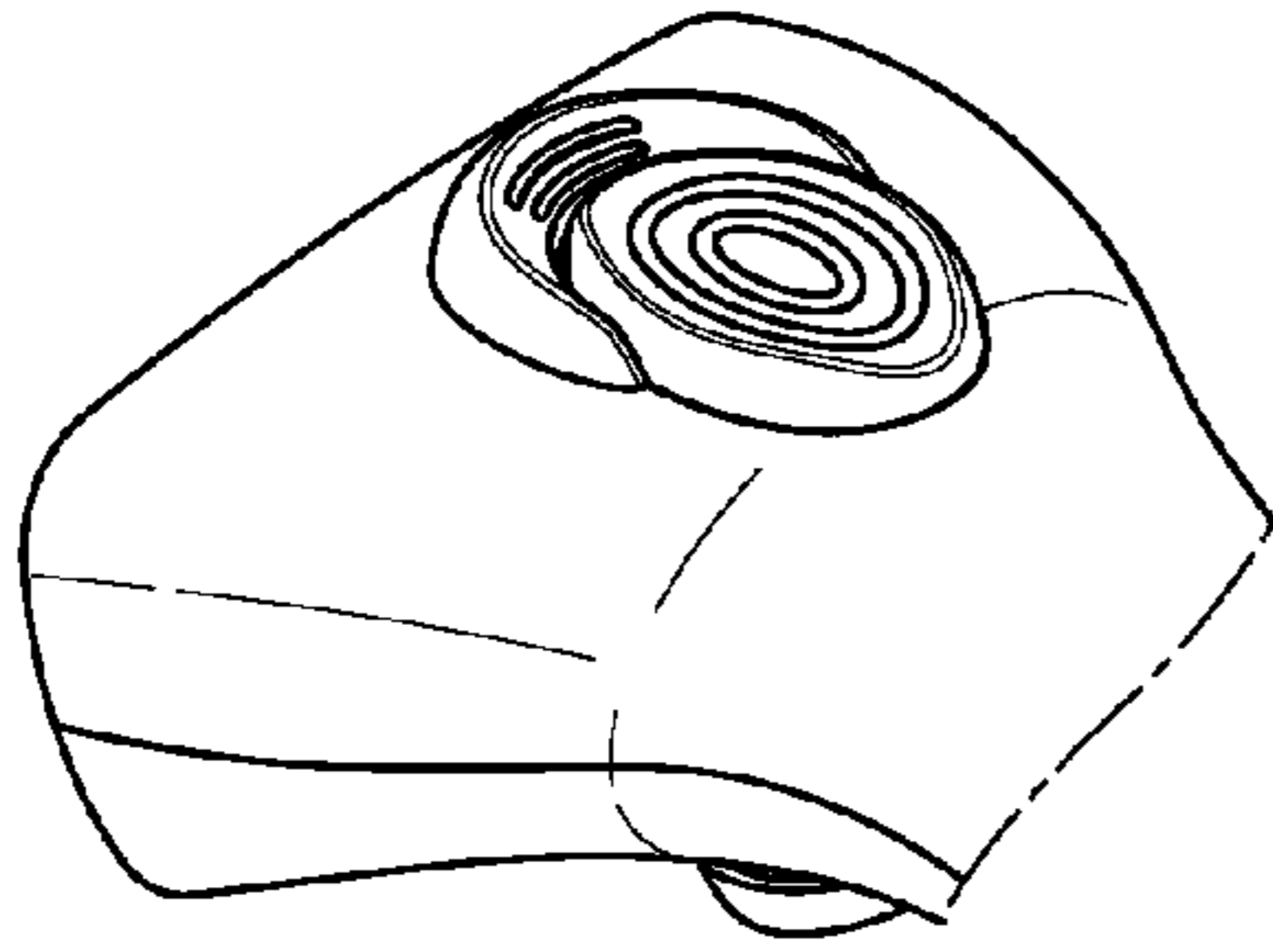

FIG. 1

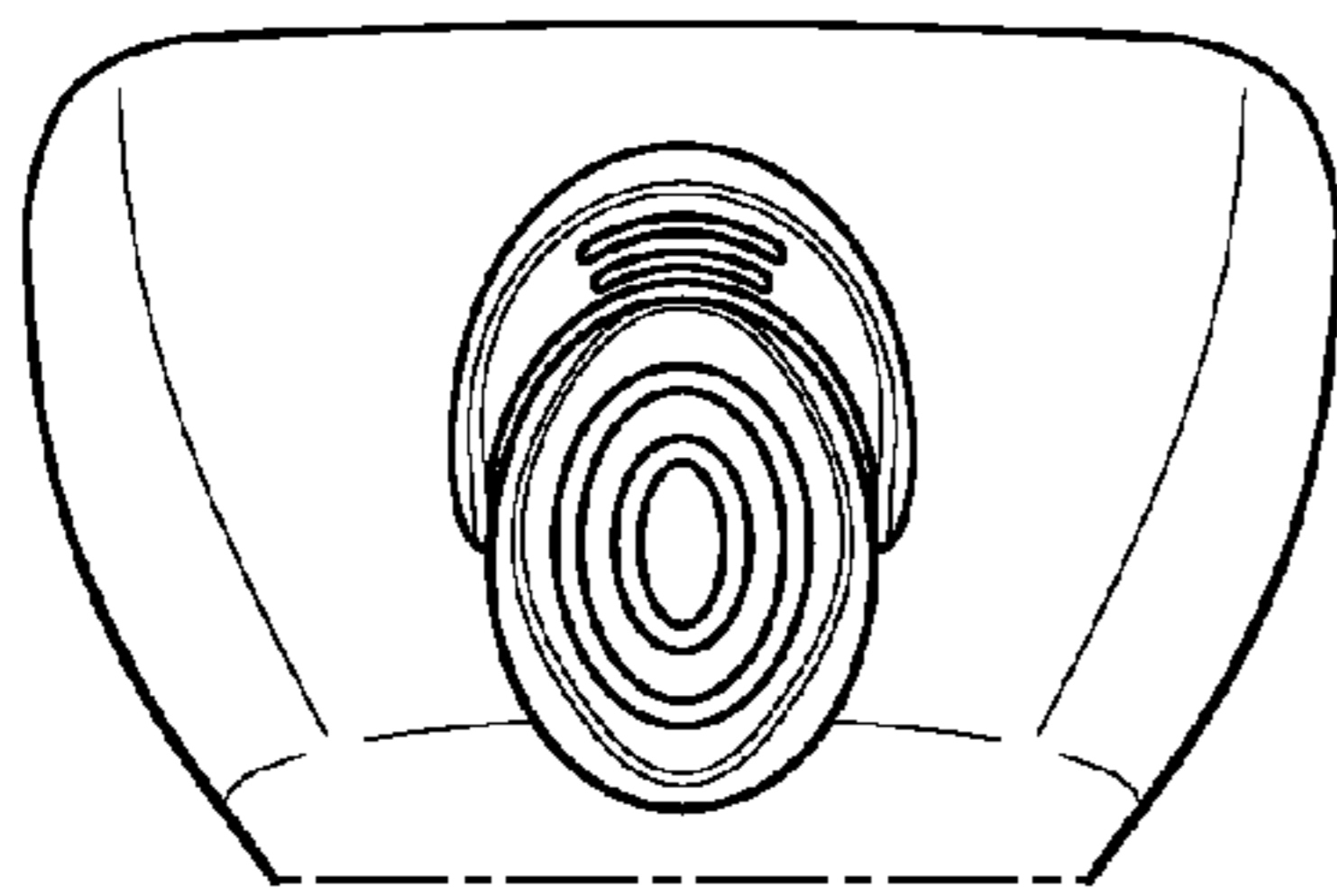

FIG. 2

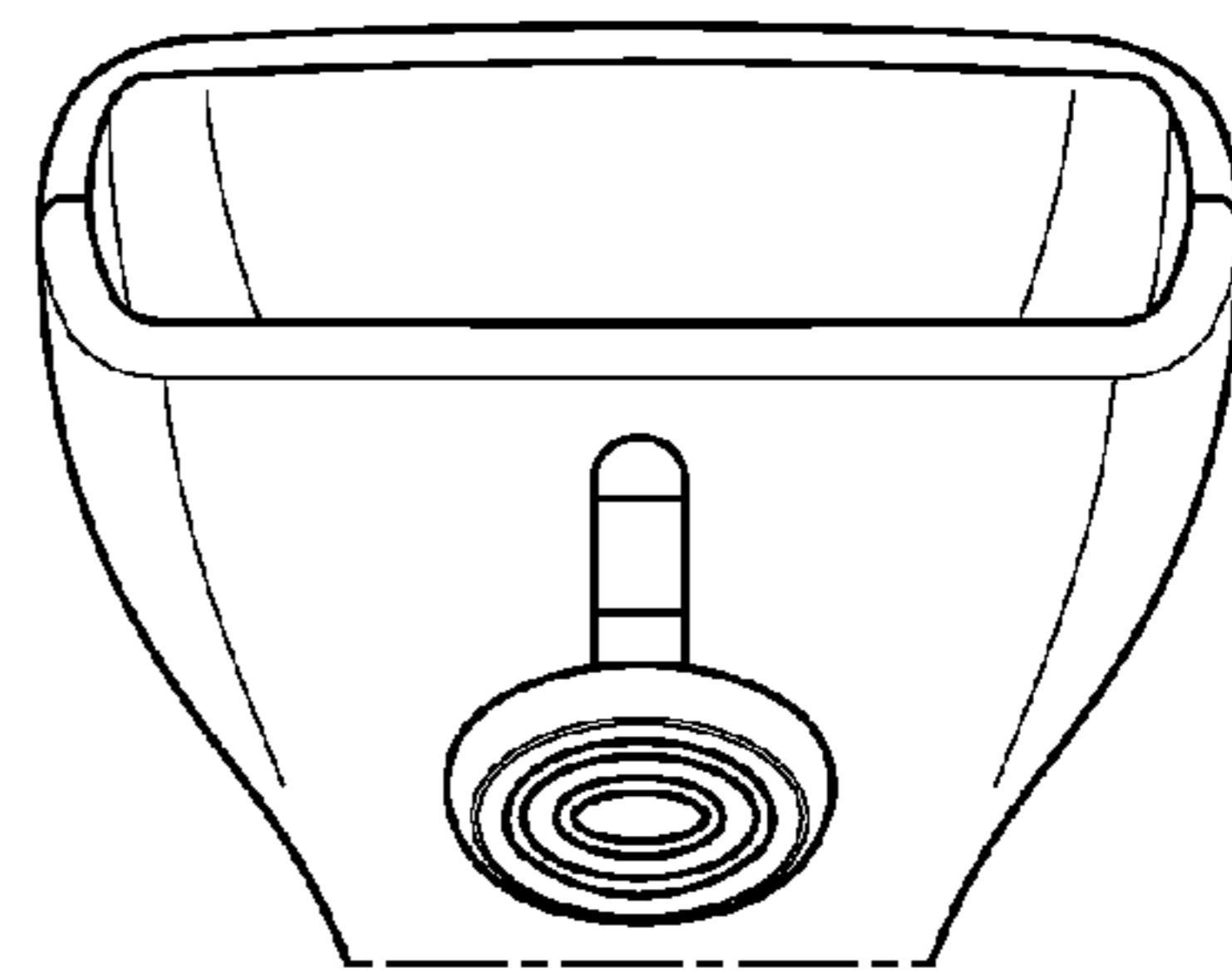

FIG. 3

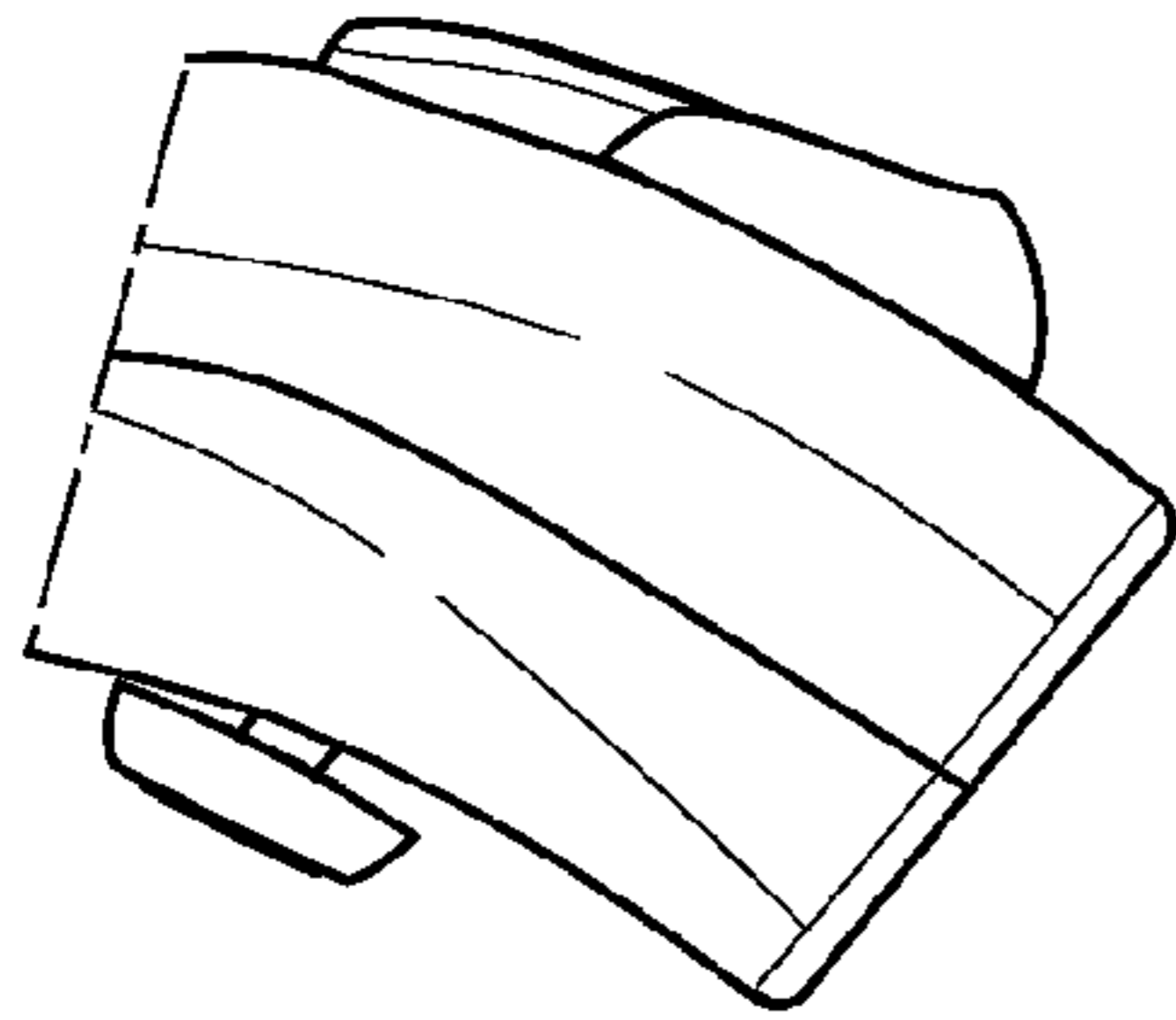

FIG. 4

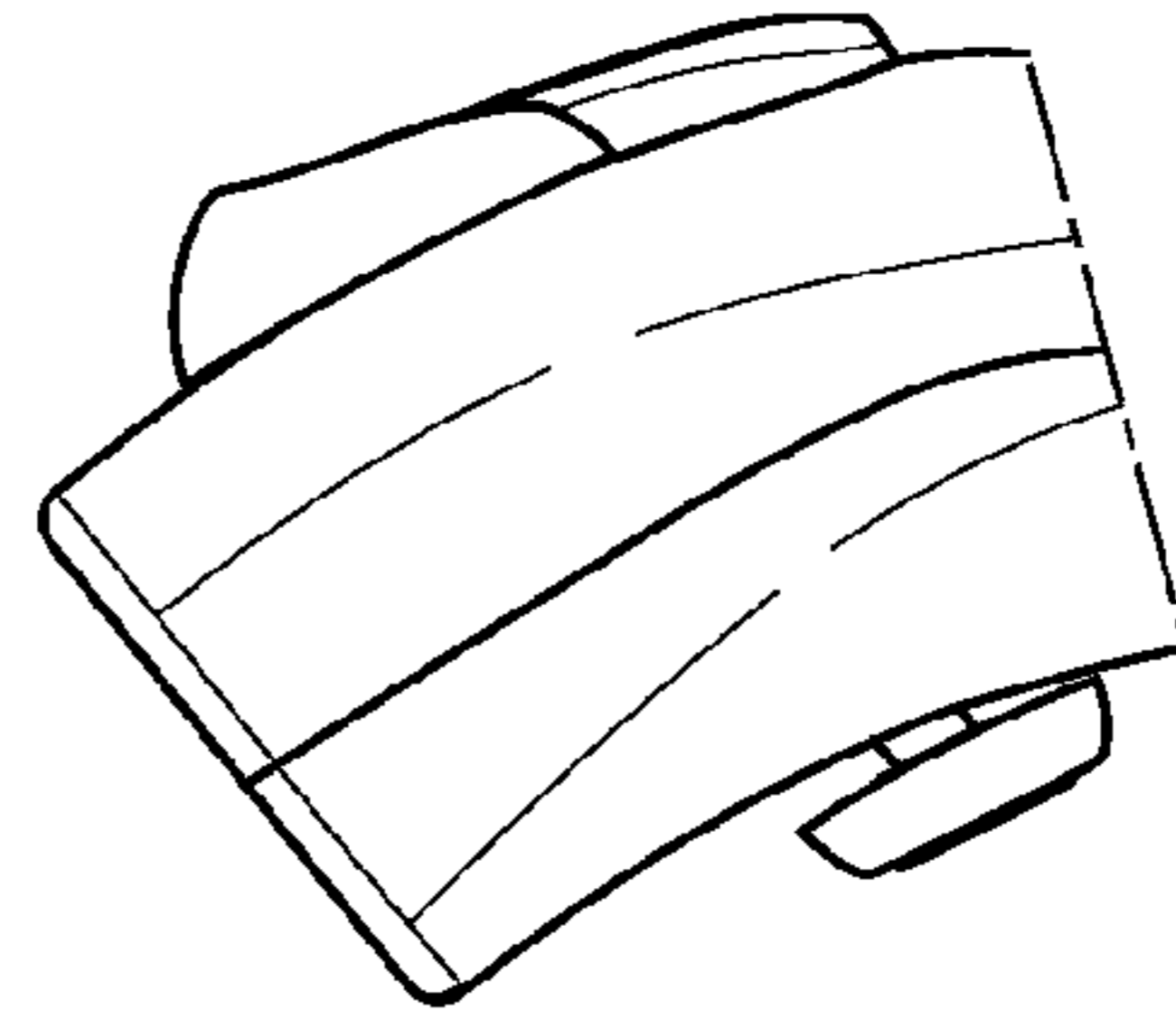

FIG. 5

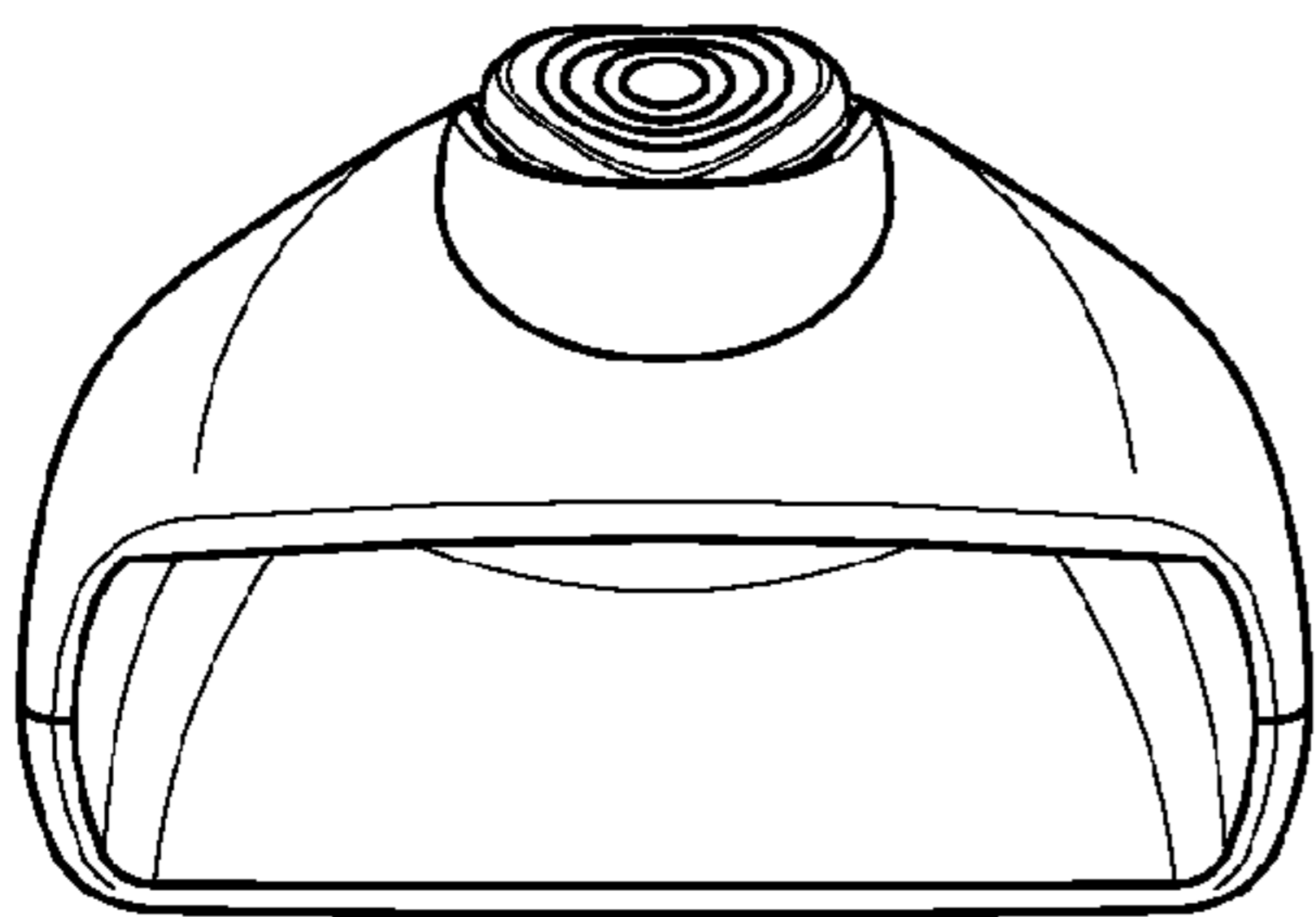

FIG. 6

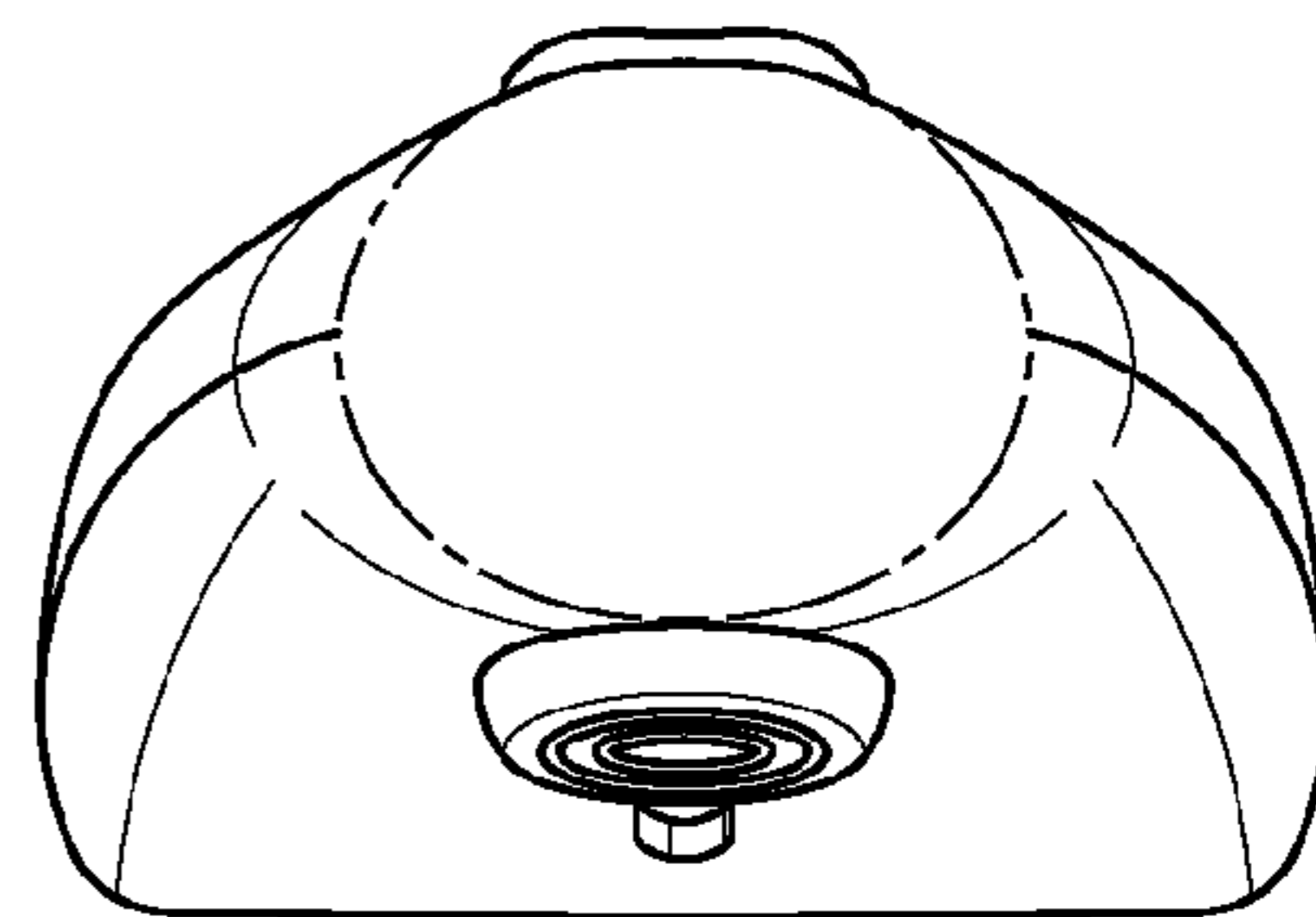

FIG. 7