



US00D607137S

(12) **United States Design Patent**
Chen

(10) **Patent No.:** **US D607,137 S**

(45) **Date of Patent:** **** Dec. 29, 2009**

(54) **LIGHT FIXTURE**

D577,850 S * 9/2008 Nicholas D26/88

(76) Inventor: **Chia-Teh Chen**, 5F., No. 30, Yisian Rd.,
Taipei City (TW)

OTHER PUBLICATIONS

Pendant Light Model #CP4320 from the Miami ID family by Visa
Lighting. Downloaded from visalighting.com Sep. 13, 2009.*

(**) Term: **14 Years**

* cited by examiner

(21) Appl. No.: **29/311,949**

Primary Examiner—Clare E Heflin

(22) Filed: **Aug. 5, 2009**

(74) *Attorney, Agent, or Firm*—Rosenberg, Klein & Lee

(51) **LOC (9) Cl.** **26-03**

(52) **U.S. Cl.** **D26/88; D26/90**

(58) **Field of Classification Search** D26/59,
D26/72, 80–91, 128; 362/147, 404, 453–456
See application file for complete search history.

(57) **CLAIM**

The ornamental design for a “light fixture,” as shown and
described.

(56) **References Cited**

DESCRIPTION

U.S. PATENT DOCUMENTS

FIG. 1 is a perspective view of a “light fixture” showing my
new design;

- D51,188 S * 8/1917 Snow D26/88
- D67,337 S * 5/1925 Chappell D26/81
- D71,025 S * 9/1926 Krause D26/81
- D361,151 S * 8/1995 Corbett D26/90
- D403,799 S * 1/1999 Dolan D26/90
- D430,331 S * 8/2000 Bleisch D26/91
- D438,328 S * 2/2001 Pan D26/88
- D441,120 S * 4/2001 Hsu D26/85
- D539,963 S * 4/2007 Hsu D26/88

FIG. 2 is a front view thereof;

FIG. 3 is a rear view thereof;

FIG. 4 is a left side view thereof;

FIG. 5 is a right side view thereof;

FIG. 6 is a top view thereof; and,

FIG. 7 is a bottom view thereof.

1 Claim, 5 Drawing Sheets

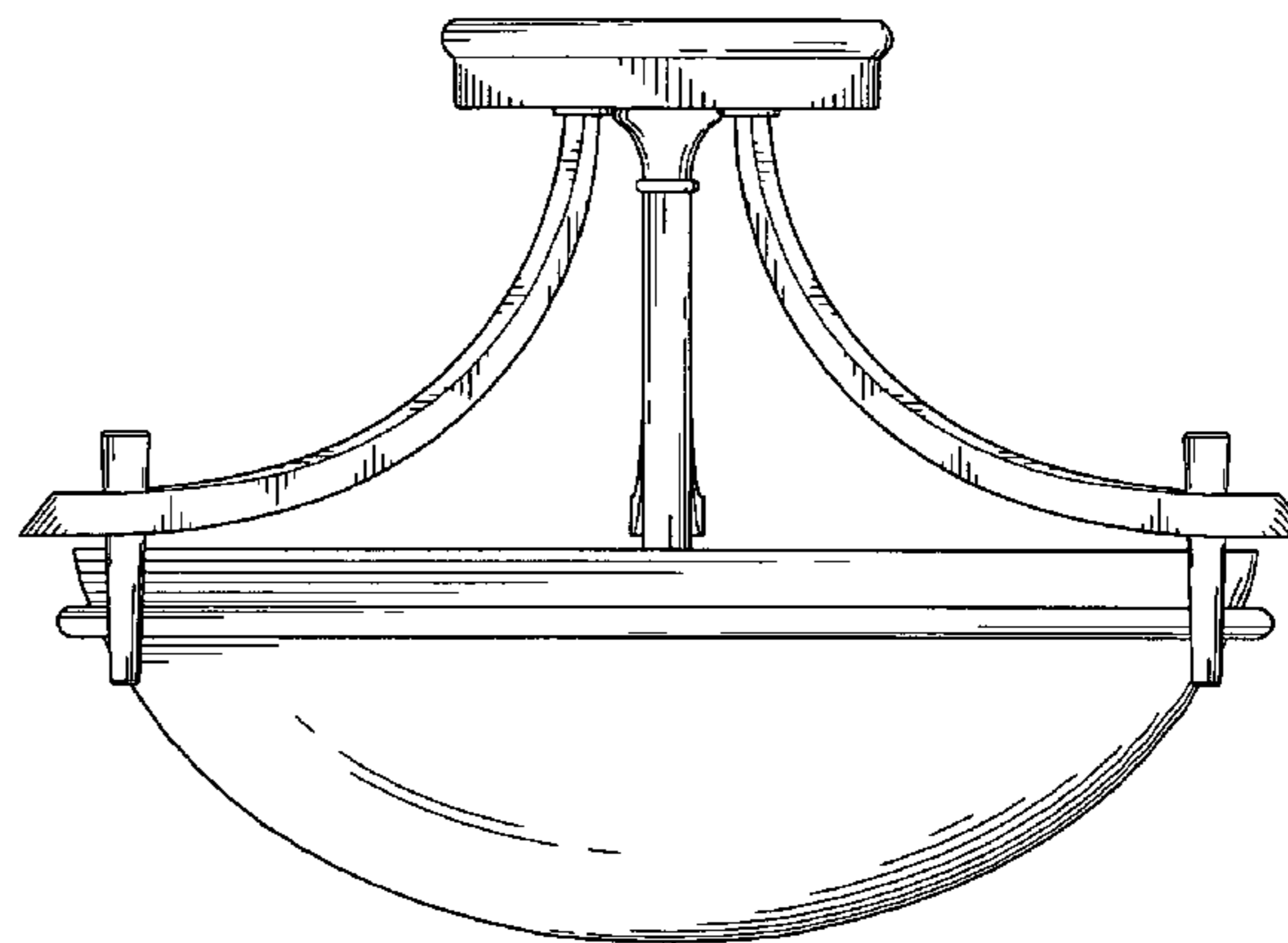
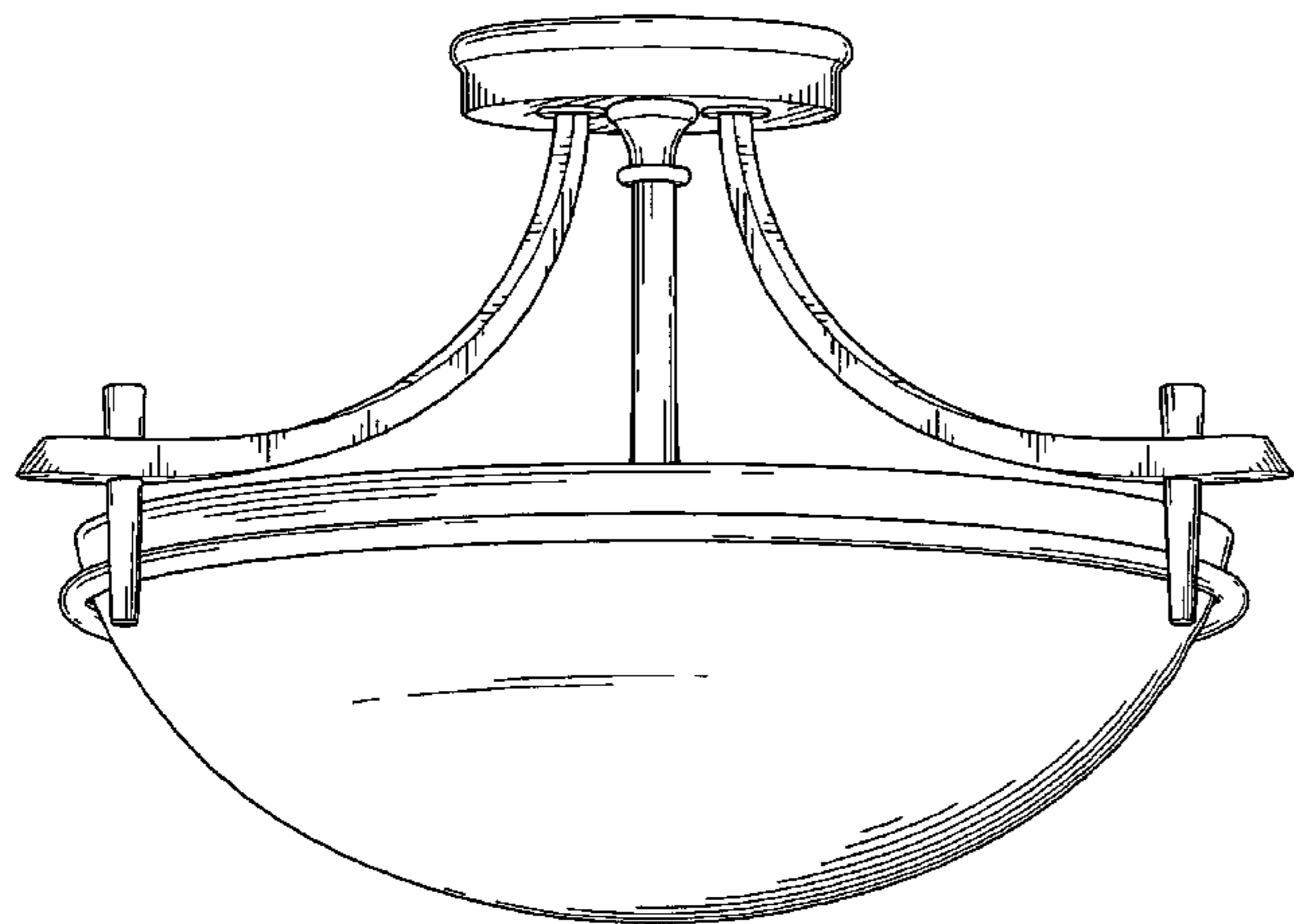

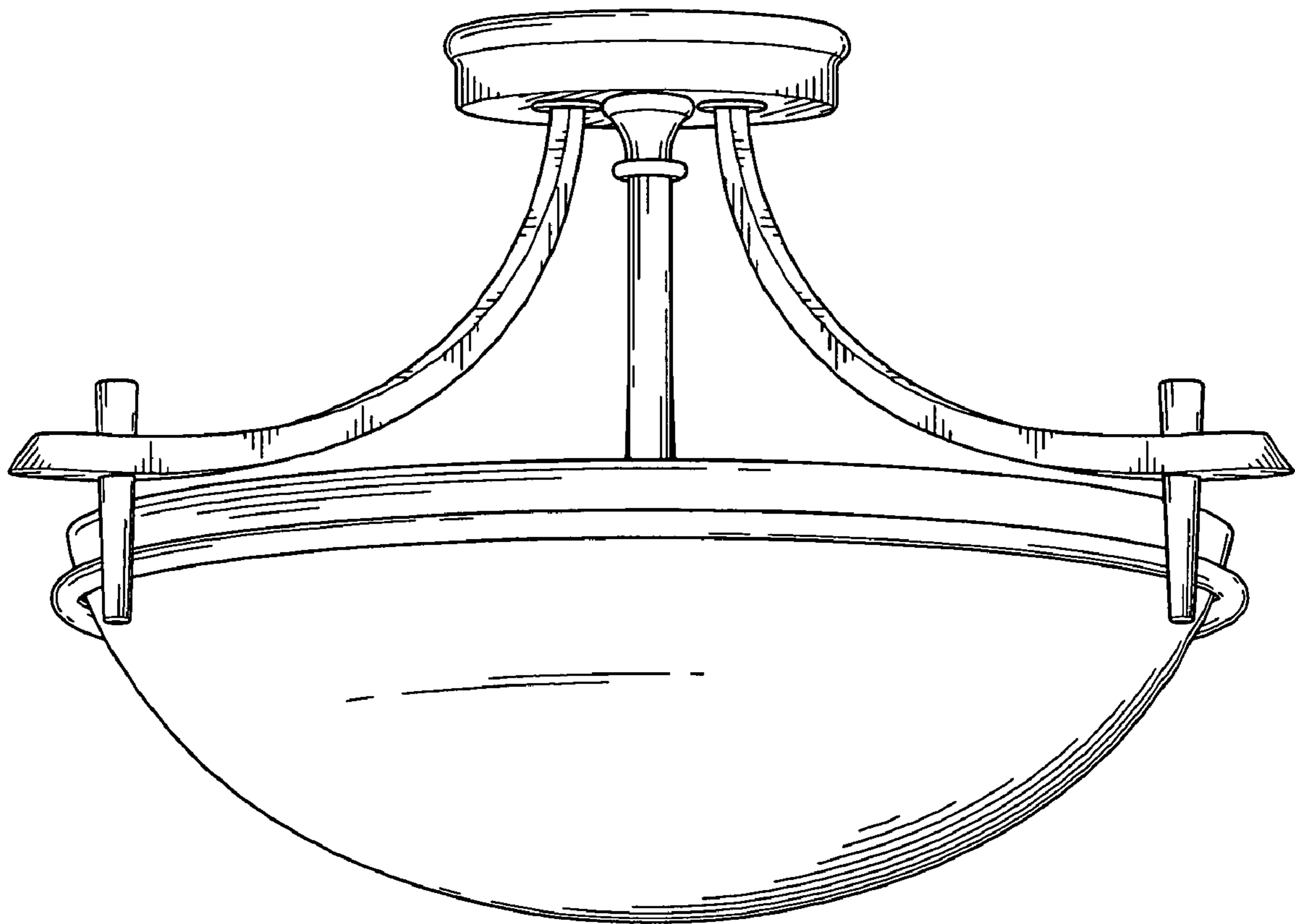

FIG. 1

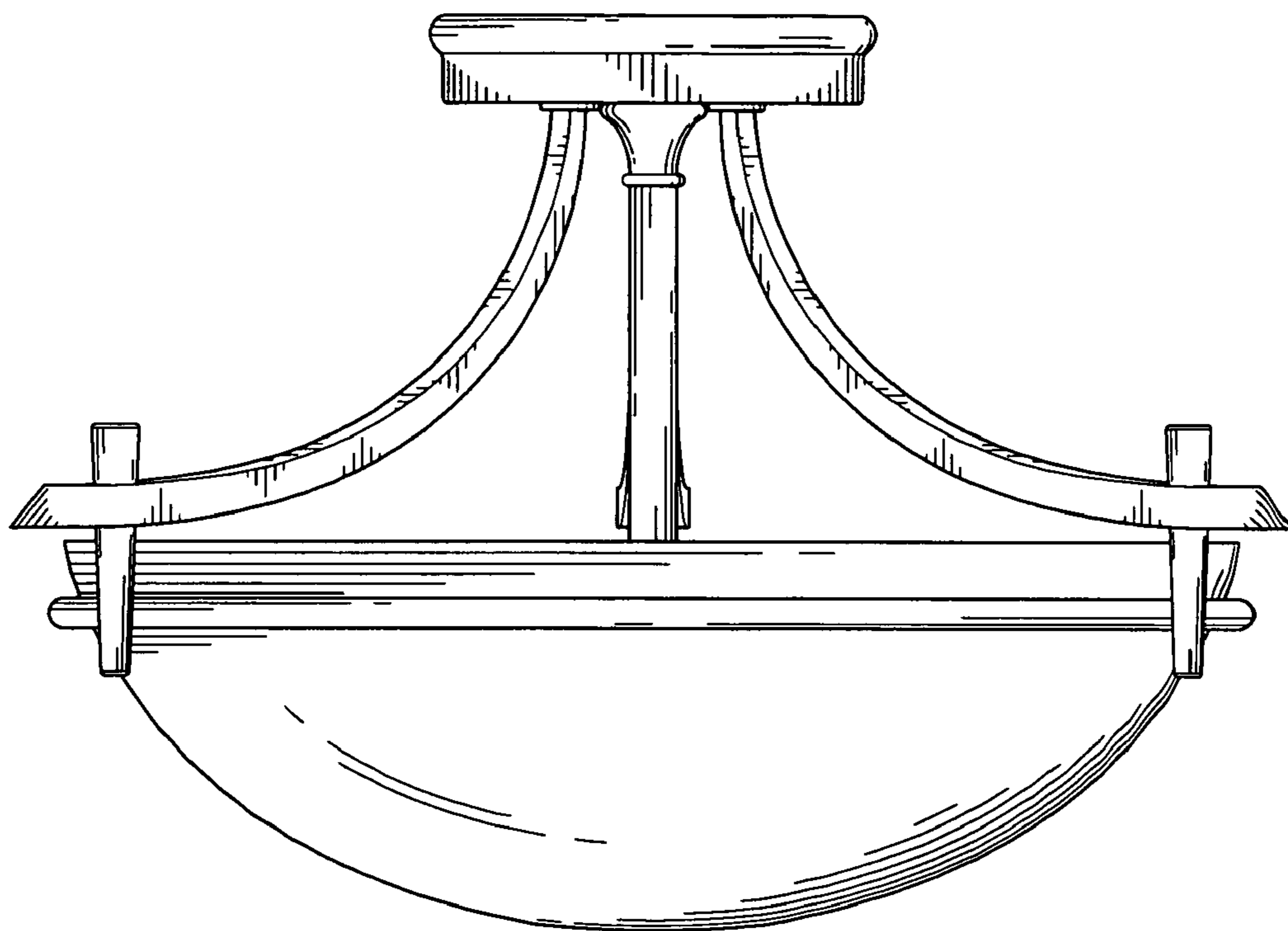

FIG. 2

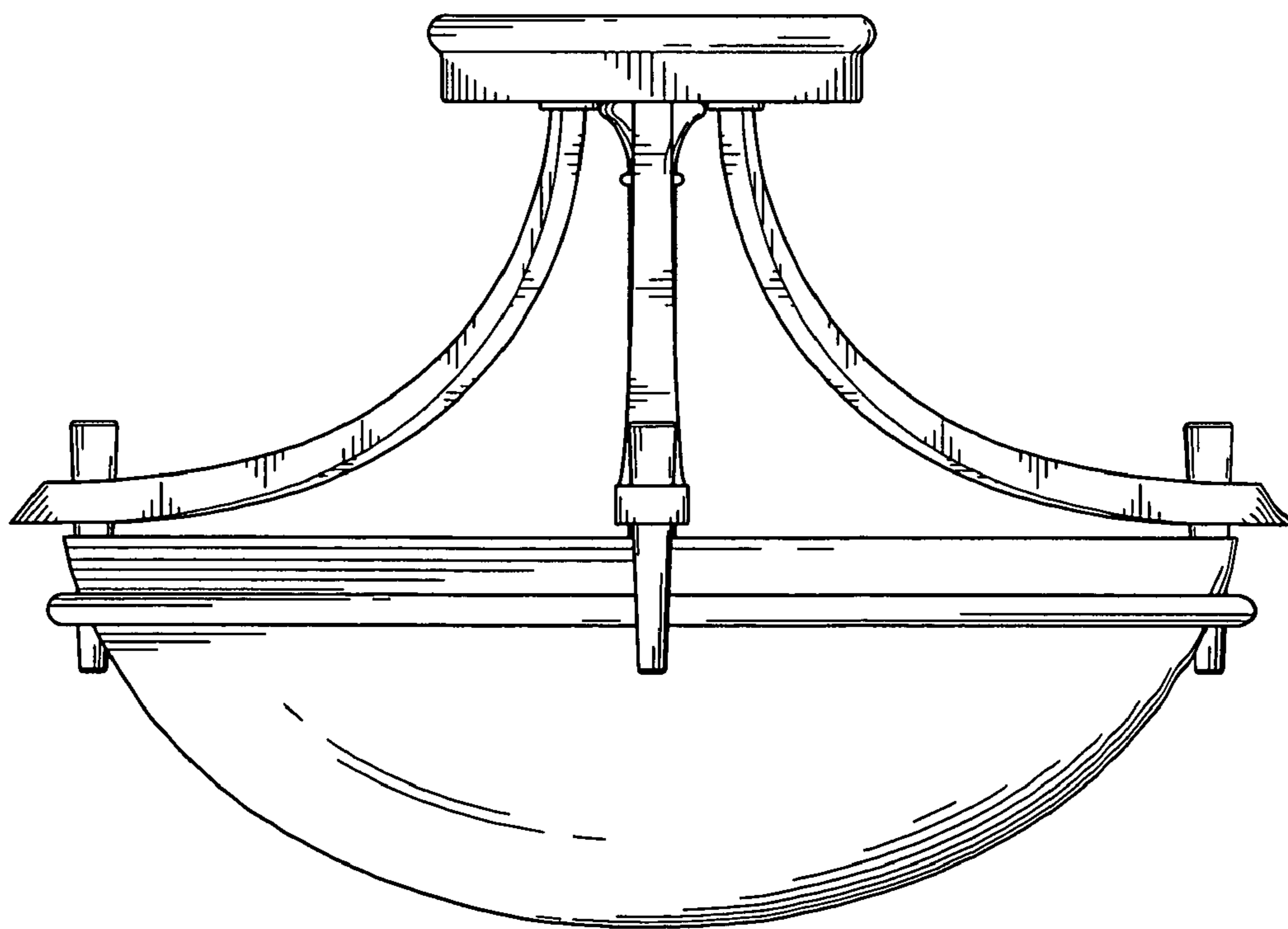

FIG. 3

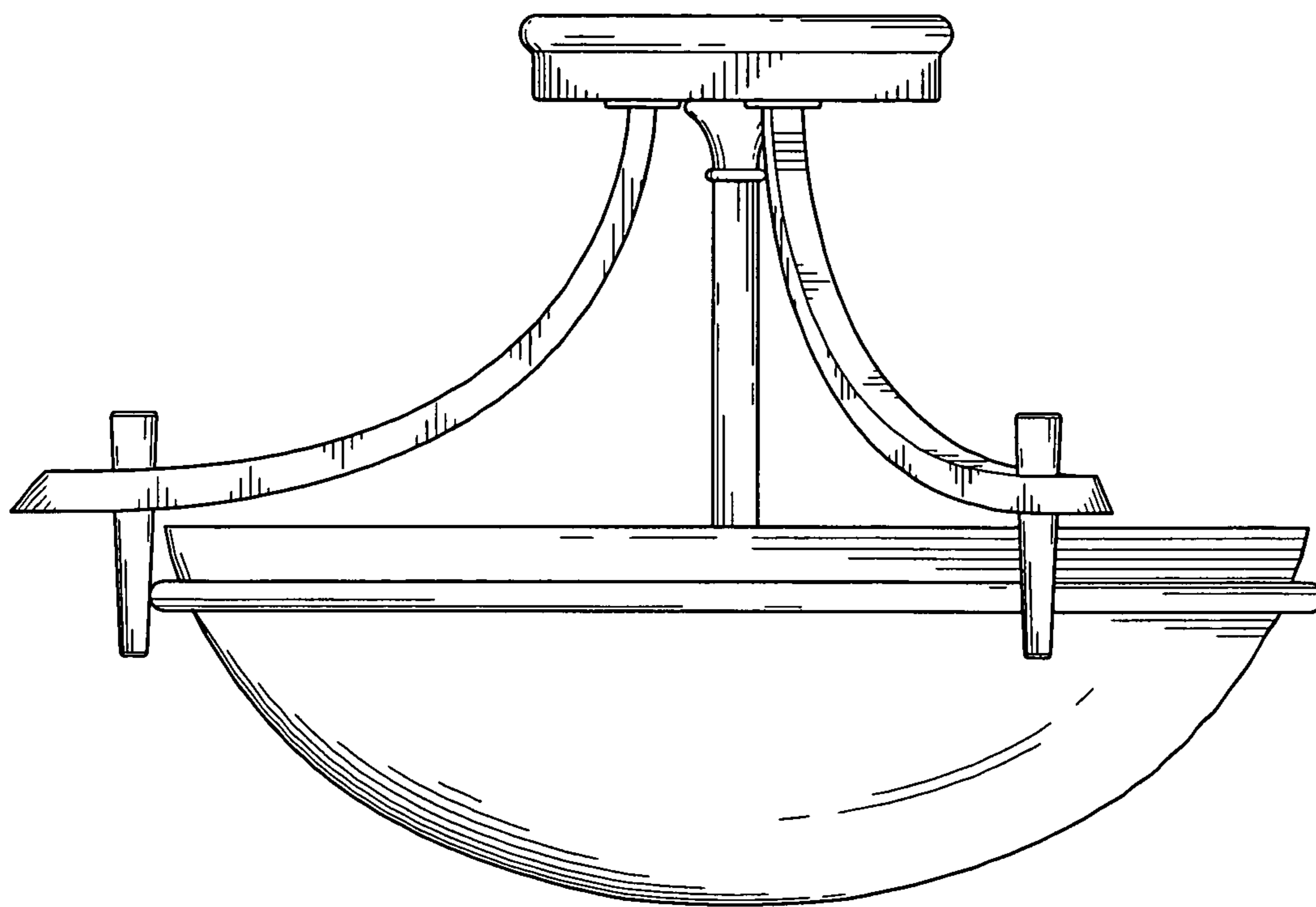

FIG. 4

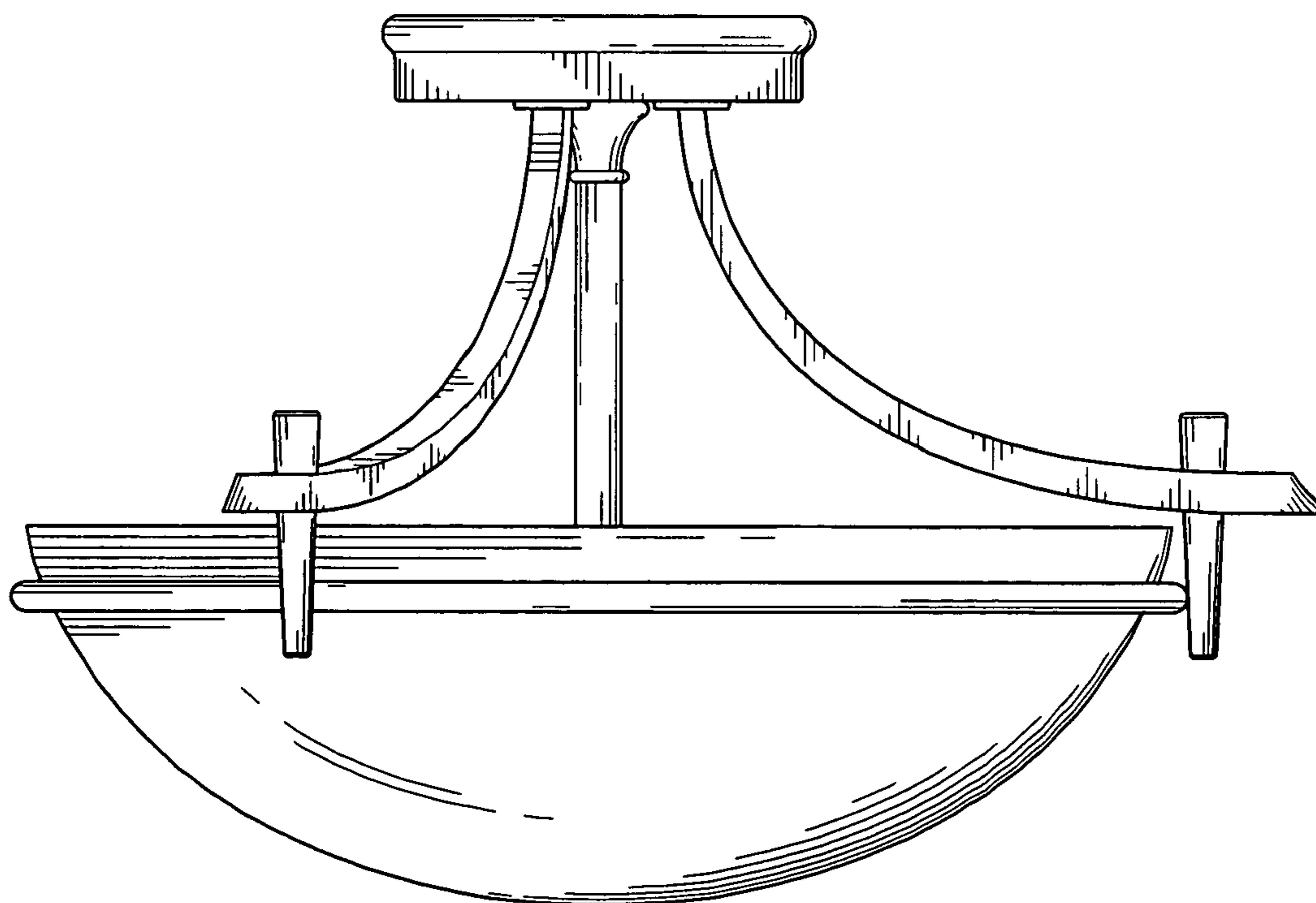

FIG. 5

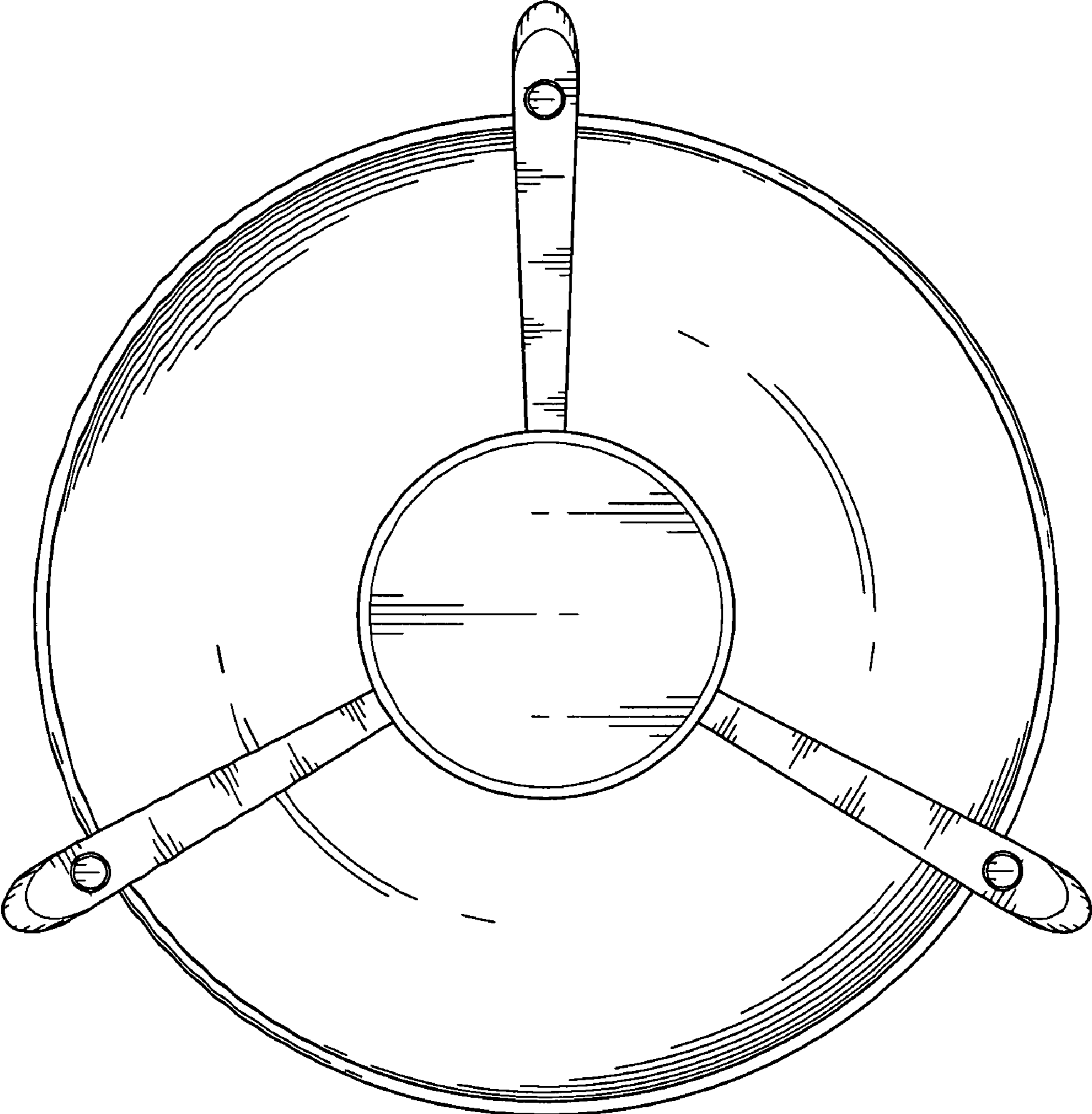

FIG. 6

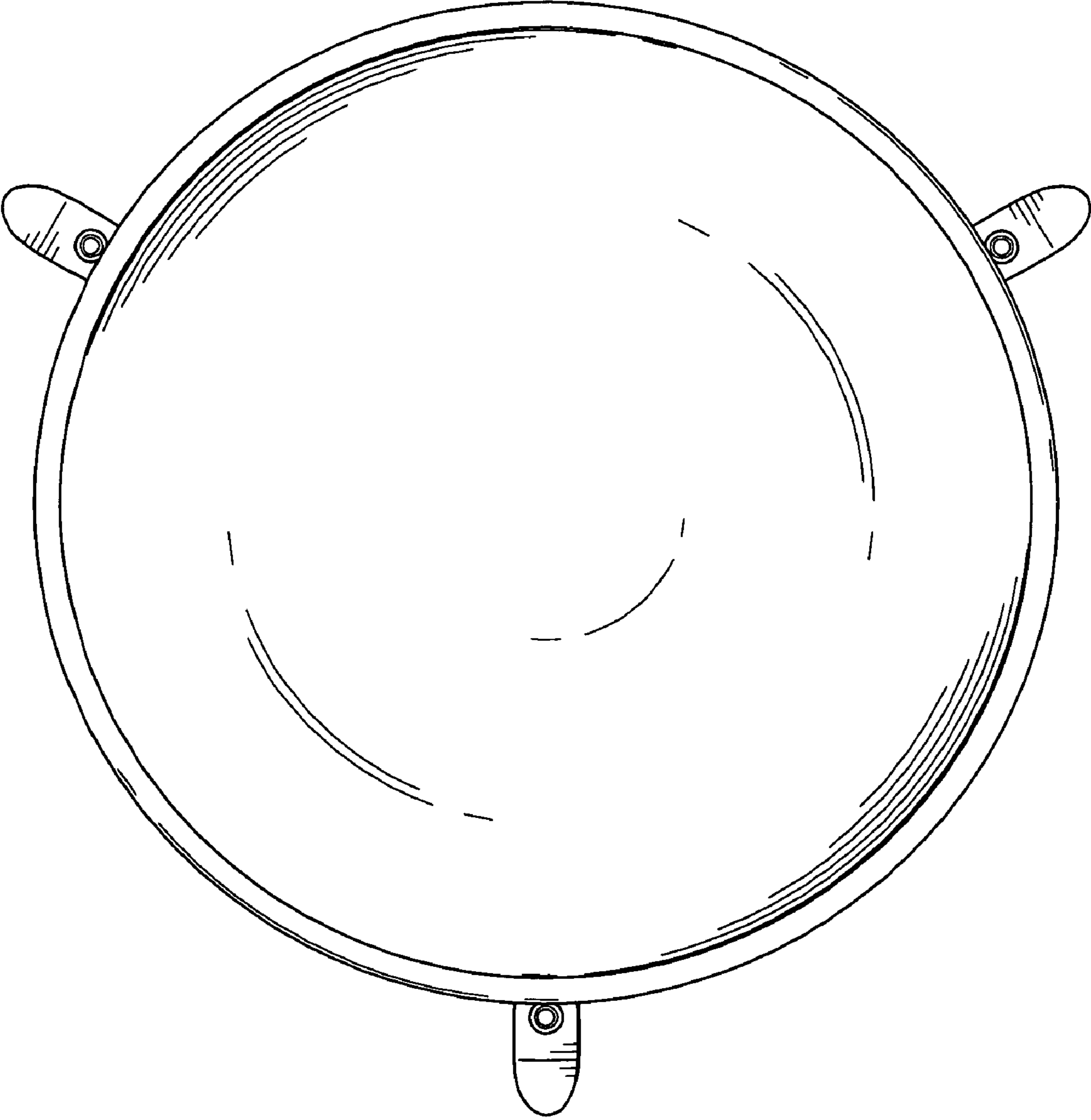

FIG. 7