



US00D607064S

(12) **United States Design Patent**  
**Thorsen**

(10) **Patent No.:** **US D607,064 S**

(45) **Date of Patent:** **\*\* Dec. 29, 2009**

(54) **TOY SHARK**

D364,660 S \* 11/1995 Rahbek ..... D21/597  
D370,037 S \* 5/1996 Berggreen ..... D21/597

(75) Inventor: **Gitte Thorsen**, Billund (DK)

\* cited by examiner

(73) Assignee: **Lego A/S**, Billund (DK)

*Primary Examiner*—Sandra Morris

(\*\*) Term: **14 Years**

(74) *Attorney, Agent, or Firm*—Day Pitney LLP

(21) Appl. No.: **29/294,851**

(57) **CLAIM**

(22) Filed: **Jan. 30, 2008**

The ornamental design for a toy shark, as shown and described.

(51) **LOC (9) Cl.** ..... **21-01**

(52) **U.S. Cl.** ..... **D21/599**

(58) **Field of Classification Search** ..... D11/157–158;  
D21/576, 597, 599, 493; 446/72, 97, 153  
See application file for complete search history.

**DESCRIPTION**

FIG. 1 is a right side view of my design of a toy element;

FIG. 2 is a rear side view thereof;

FIG. 3 is a left side view thereof;

FIG. 4 is a front side view thereof;

FIG. 5 is a bottom view thereof, the portions shown in broken line playing no part in my design;

FIG. 6 is a top view thereof; and,

FIG. 7 is a top perspective view thereof.

(56) **References Cited**

U.S. PATENT DOCUMENTS

- D317,800 S \* 6/1991 Laursen ..... D21/599
- D317,801 S \* 6/1991 Tapdrup ..... D21/599
- D330,575 S \* 10/1992 Kupperman ..... D21/599
- D333,854 S \* 3/1993 Kupperman ..... D21/599
- D334,955 S \* 4/1993 Kupperman ..... D21/599

**1 Claim, 7 Drawing Sheets**

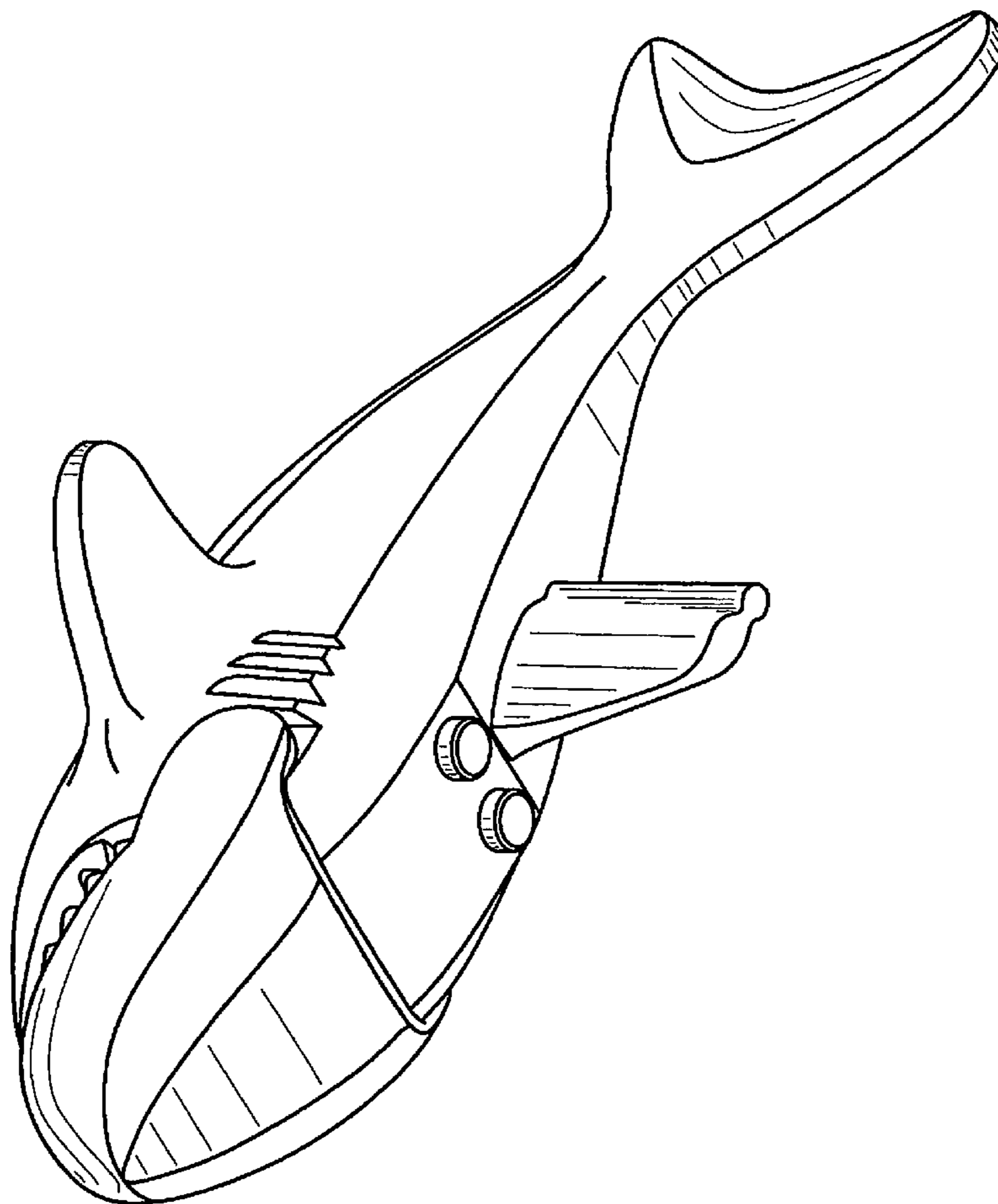

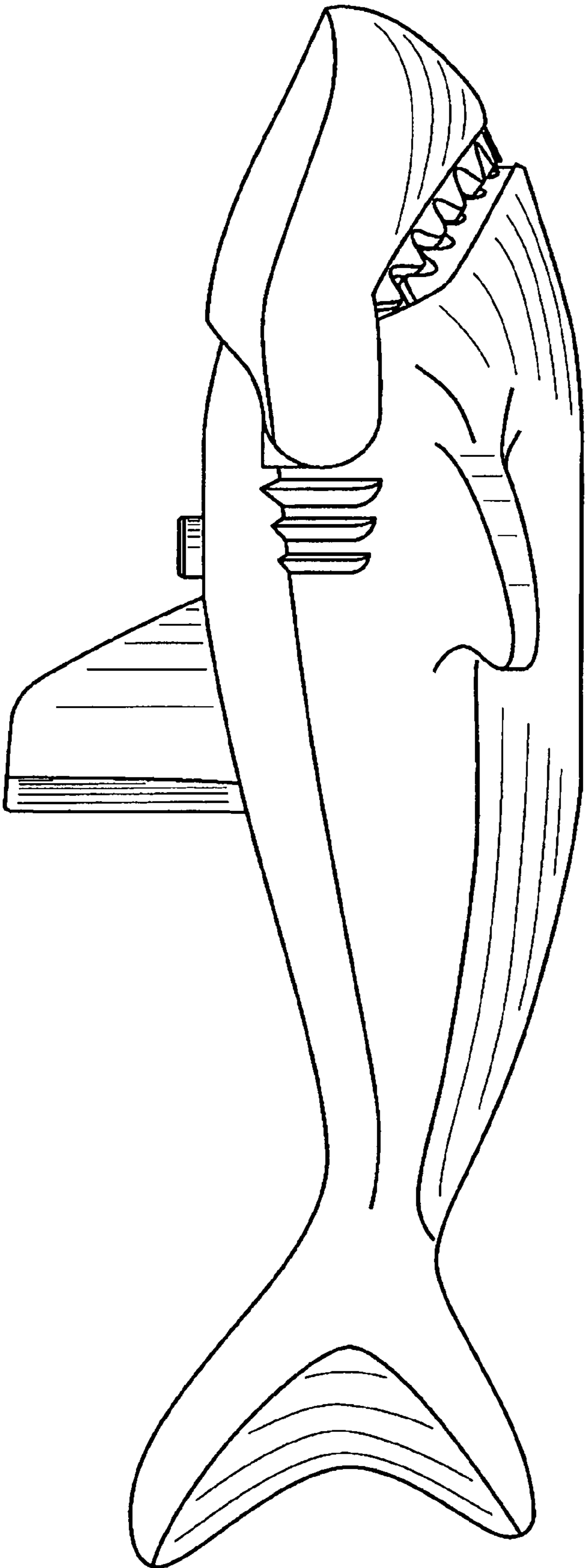

FIG. 1

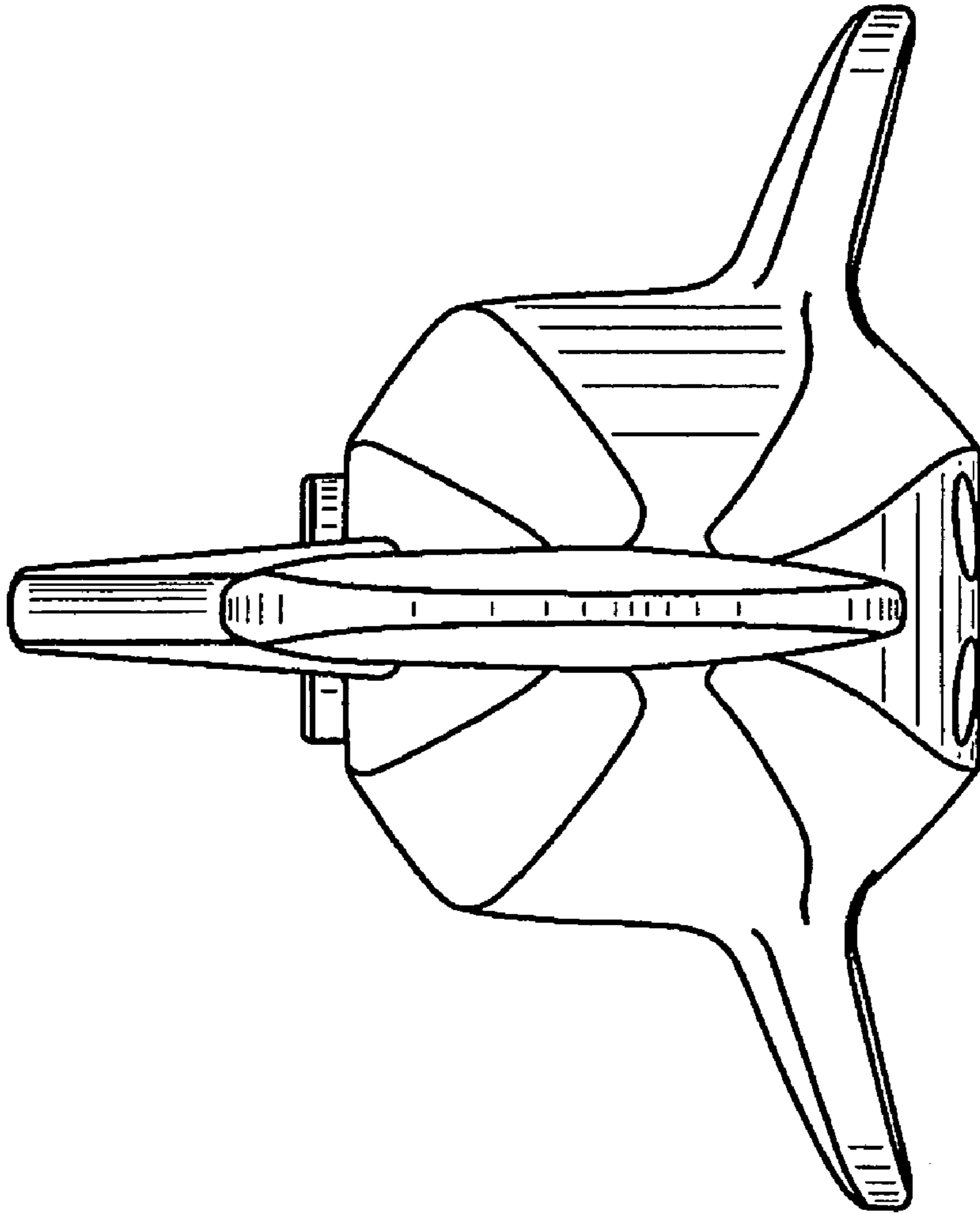

FIG. 2

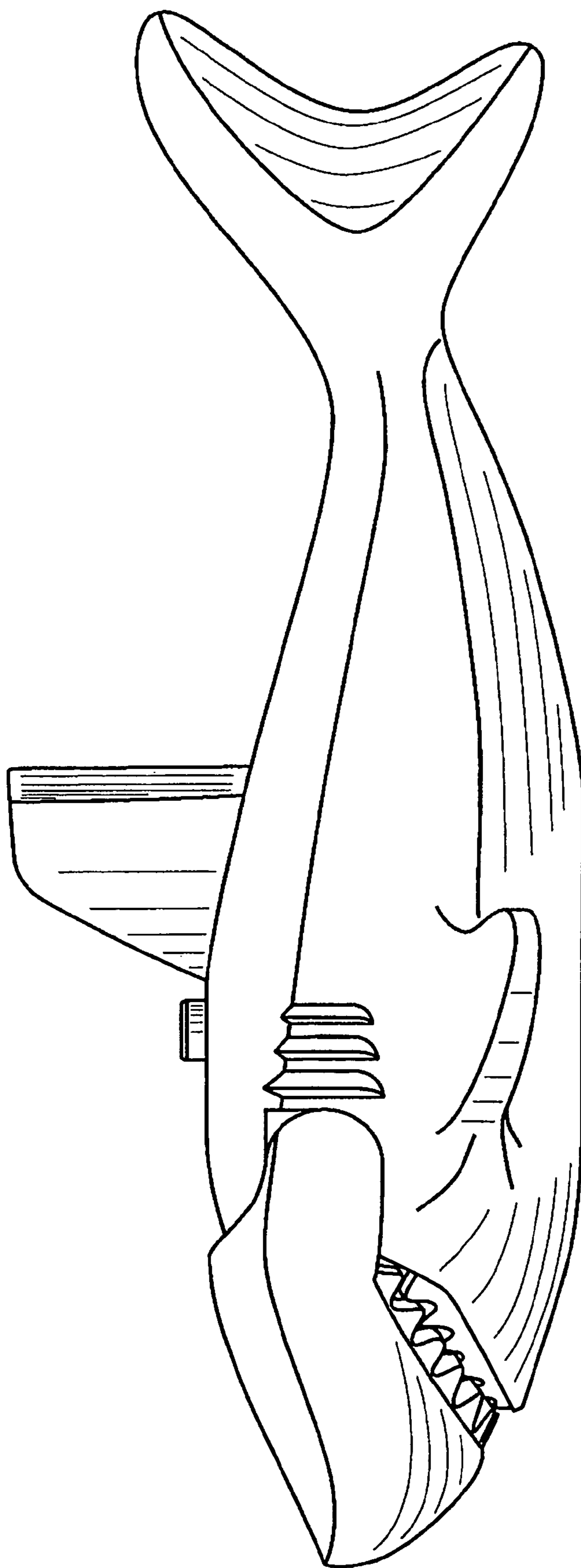

FIG. 3

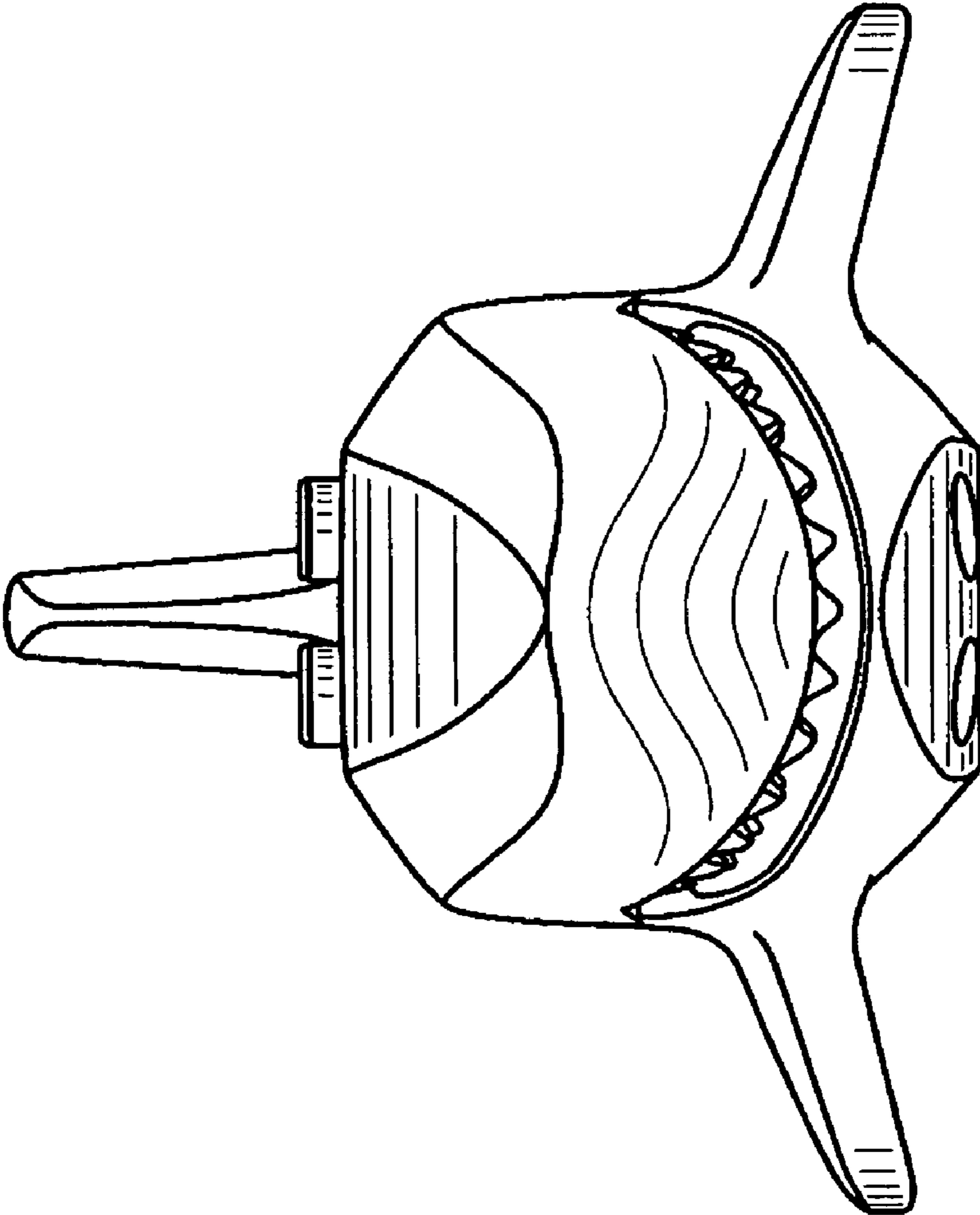

FIG. 4

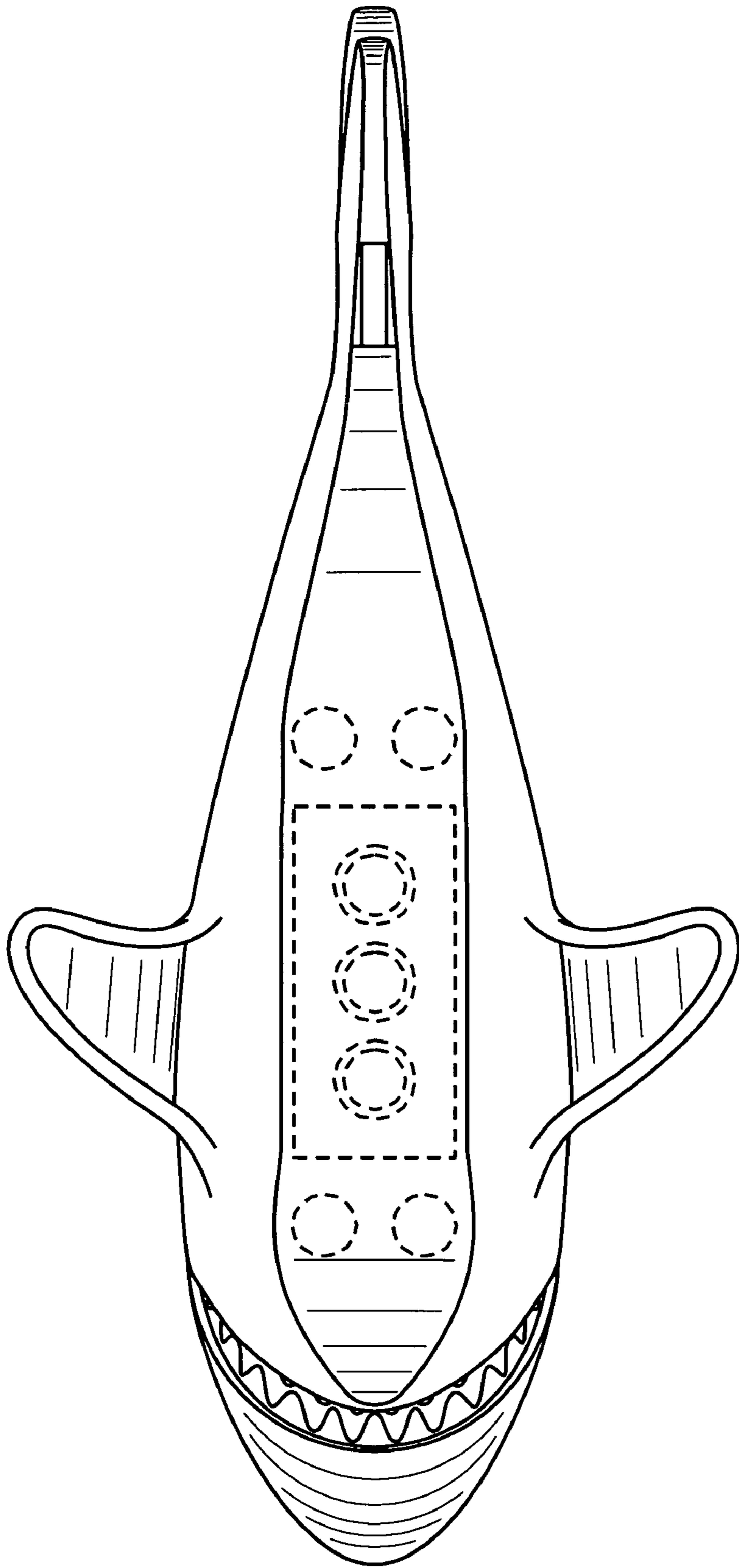

FIG. 5

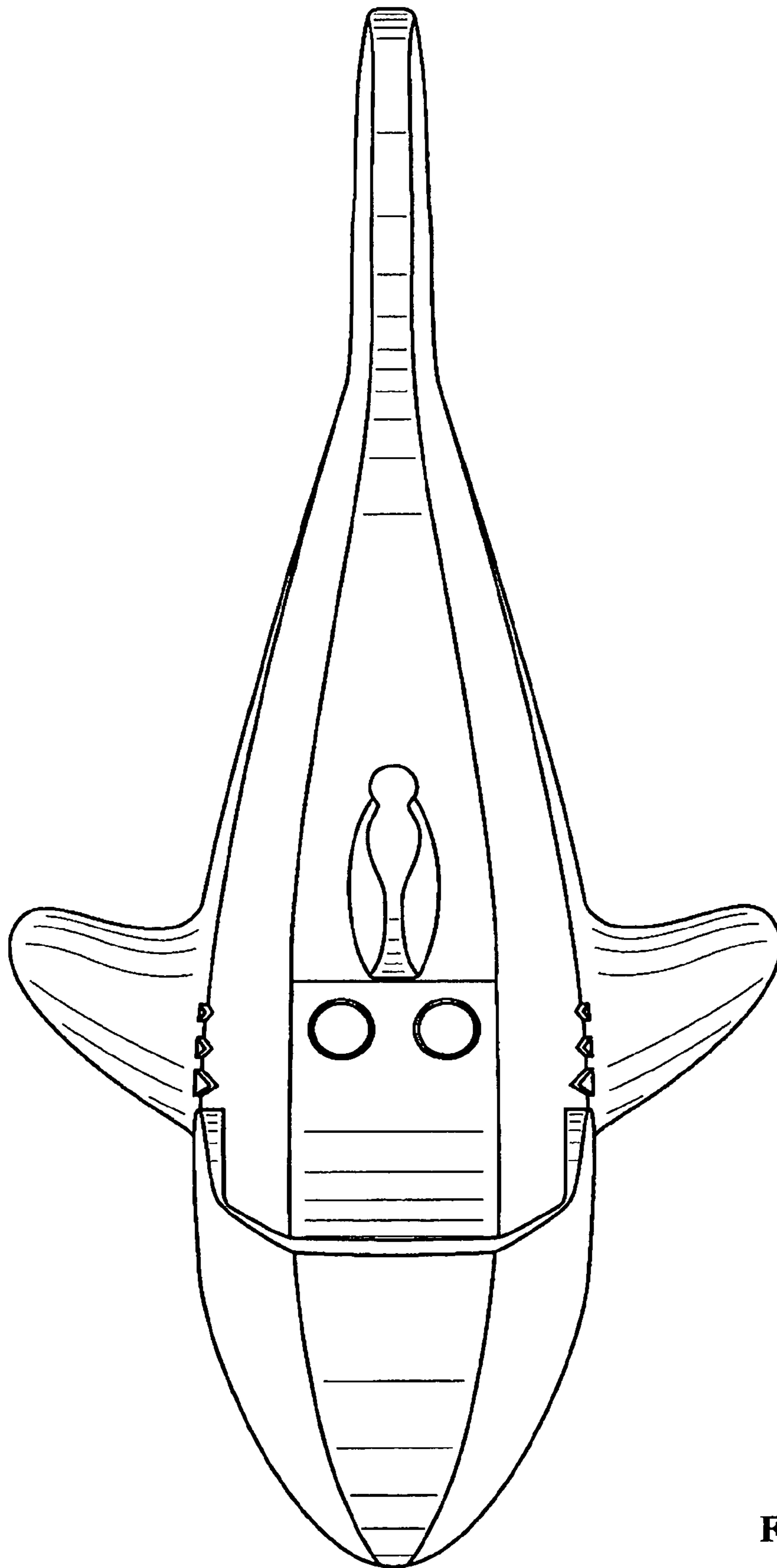

FIG. 6

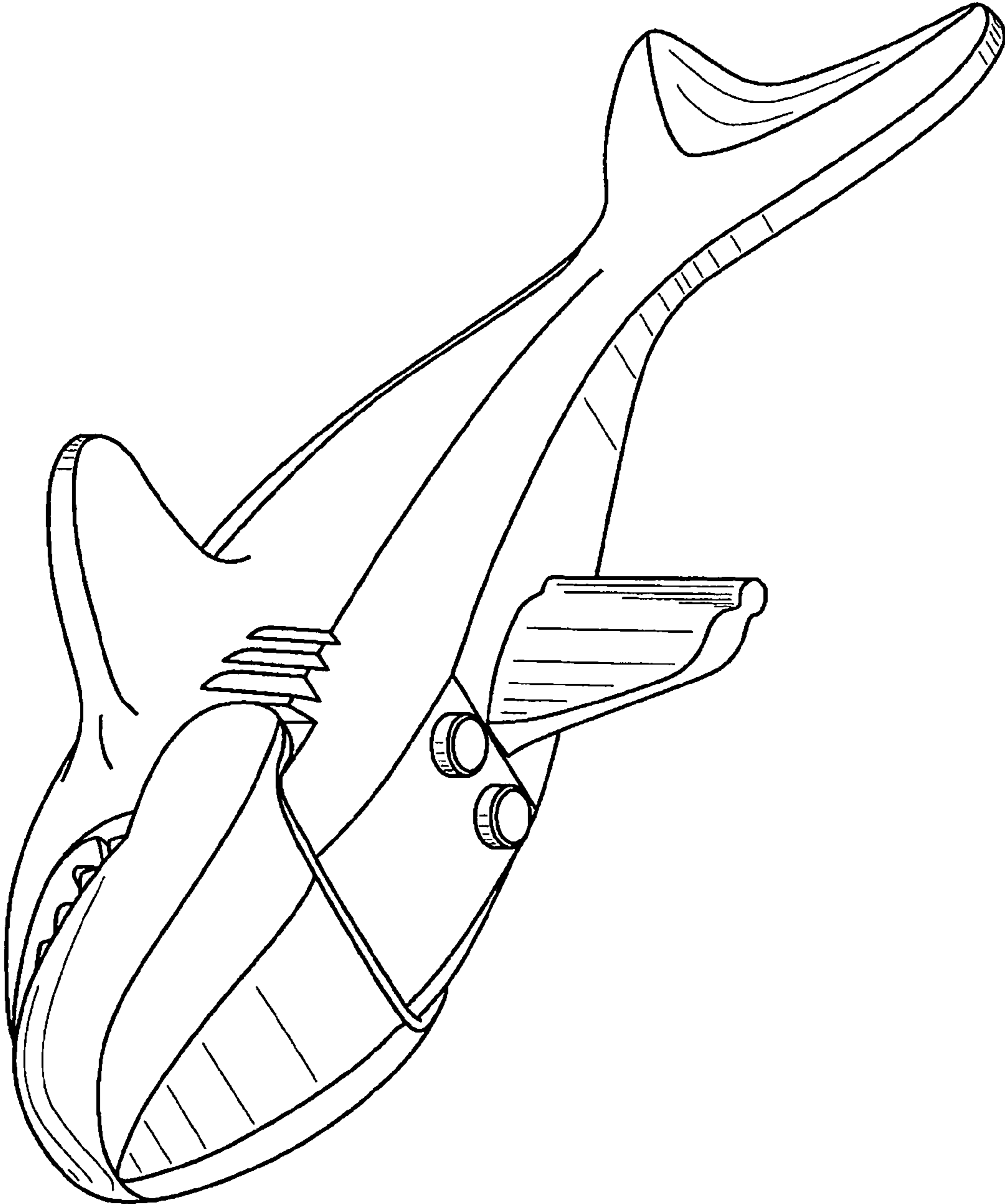

FIG. 7