



US00D607061S

(12) **United States Design Patent**
Kosir

(10) **Patent No.:** **US D607,061 S**

(45) **Date of Patent:** **** Dec. 29, 2009**

(54) **LABEL AND DISPLAY CARD HOLDER**

D579,984 S * 11/2008 Bruegmann et al. D20/43
2002/0129528 A1* 9/2002 Nagel 40/661

(75) Inventor: **Joseph P. Kosir**, Euclid, OH (US)

OTHER PUBLICATIONS

(73) Assignee: **Fasteners For Retail, Inc.**, Cleveland, OH (US)

FFR Yellow Pages 2008 Product Catalog, Cover page and pp. 38 and 40, 2008.

(**) Term: **14 Years**

* cited by examiner

(21) Appl. No.: **29/337,079**

Primary Examiner—Janice E Seeger

Assistant Examiner—Mary Ann Calabrese

(22) Filed: **May 14, 2009**

(74) *Attorney, Agent, or Firm*—Fay Sharpe LLP

(51) **LOC (9) Cl.** **20-03**

(57) **CLAIM**

(52) **U.S. Cl.** **D20/44**

The ornamental design for a label and display card holder, as shown and described.

(58) **Field of Classification Search** D20/10,
D20/19, 42-44, 99; 40/605, 606.1, 642.02,
40/647, 649, 651, 653, 654, 655, 654.01,
40/658, 661, 661.03, 662, 666; D8/382,
D8/394

DESCRIPTION

See application file for complete search history.

FIG. 1 is a perspective view of a label and display card holder showing my new design;

(56) **References Cited**

FIG. 2 is a right side elevational view thereof, with a left side elevational view being a mirror image thereof;

U.S. PATENT DOCUMENTS

FIG. 3 is a front elevational view thereof;

- 1,521,617 A * 1/1925 Griesbach 40/649
- D202,759 S * 11/1965 Fischer D20/44
- 5,044,104 A * 9/1991 Hopperdietzel 40/654.01
- 6,026,603 A 2/2000 Kump et al.
- D432,177 S * 10/2000 Wildrick D20/44
- D479,278 S * 9/2003 Nagel D20/43
- D485,582 S * 1/2004 Valiulis D20/44
- D504,160 S * 4/2005 Abramson D20/44
- D510,602 S 10/2005 Wasilko
- D512,104 S * 11/2005 Lowry D20/44
- D531,227 S 10/2006 Mueller et al.
- D552,687 S * 10/2007 Smalley D20/44
- 7,287,350 B2 * 10/2007 Fast et al. 40/642.02
- 7,325,348 B2 2/2008 Mueller et al.
- D573,656 S 7/2008 Wamsley
- D573,657 S 7/2008 Caterinacci

FIG. 4 is a rear elevational view thereof;

FIG. 5 is a top plan view thereof;

FIG. 6 is a bottom plan view thereof;

FIG. 7 is a side elevational view thereof with the holder being flexed into an open condition and mounted to the front of an associated shelf; and,

FIG. 8 is a side elevational view thereof with the holder holding both an associated sign and an associated label and being mounted to an associated shelf.

The components illustrated in broken lines in FIGS. 7 and 8 form no part of the claimed design.

1 Claim, 3 Drawing Sheets

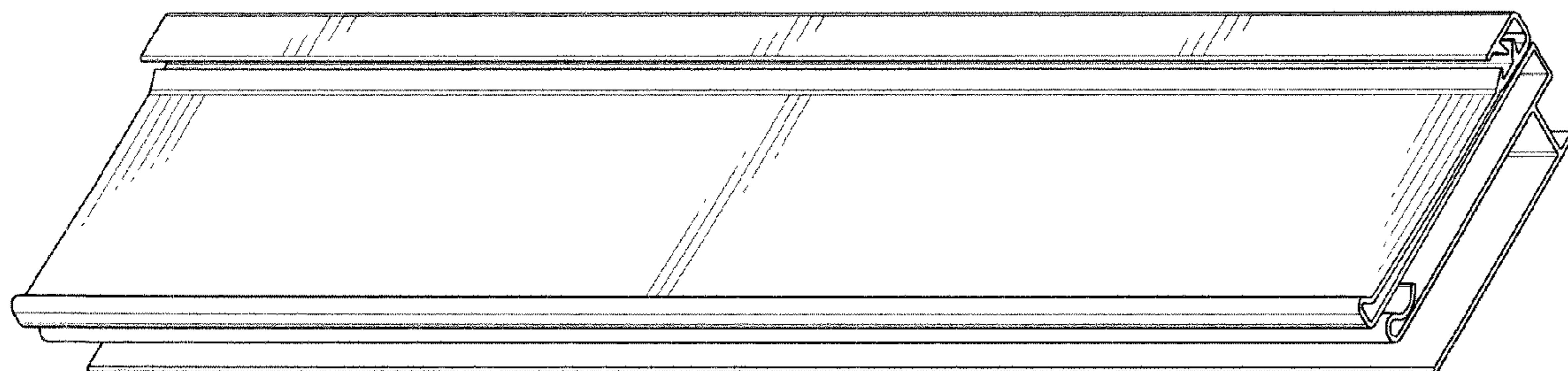

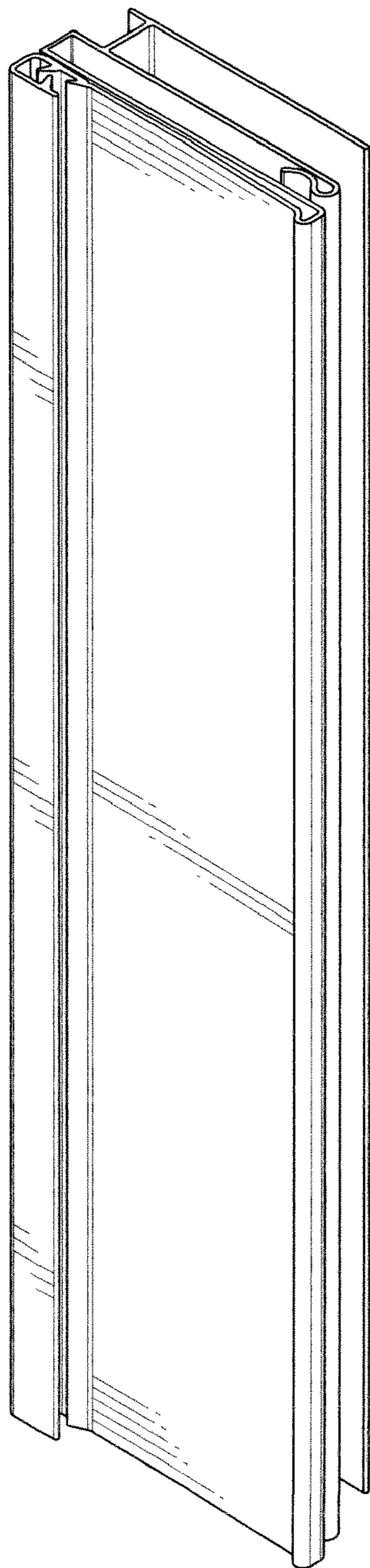

FIG. 1

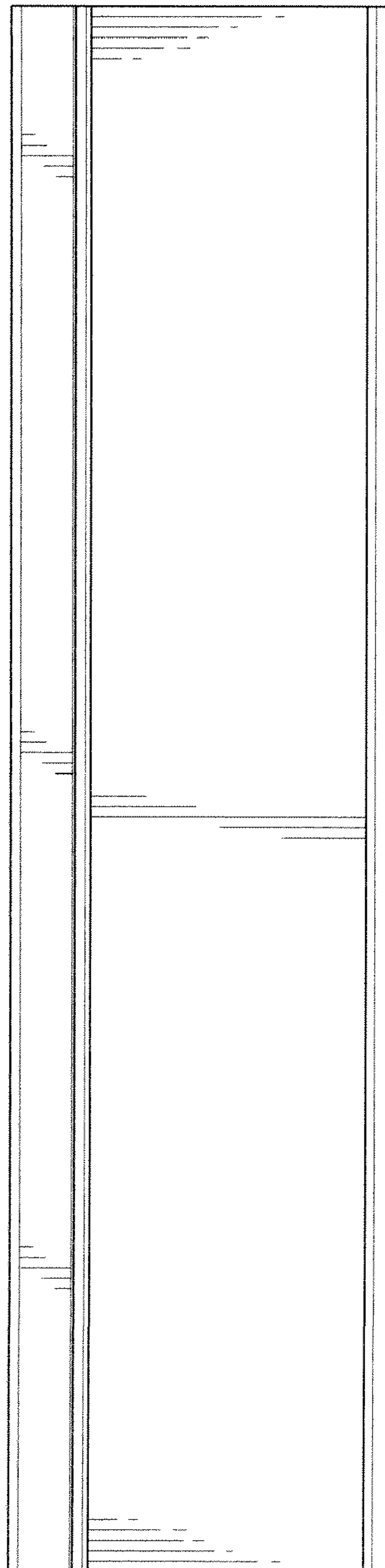

FIG. 3

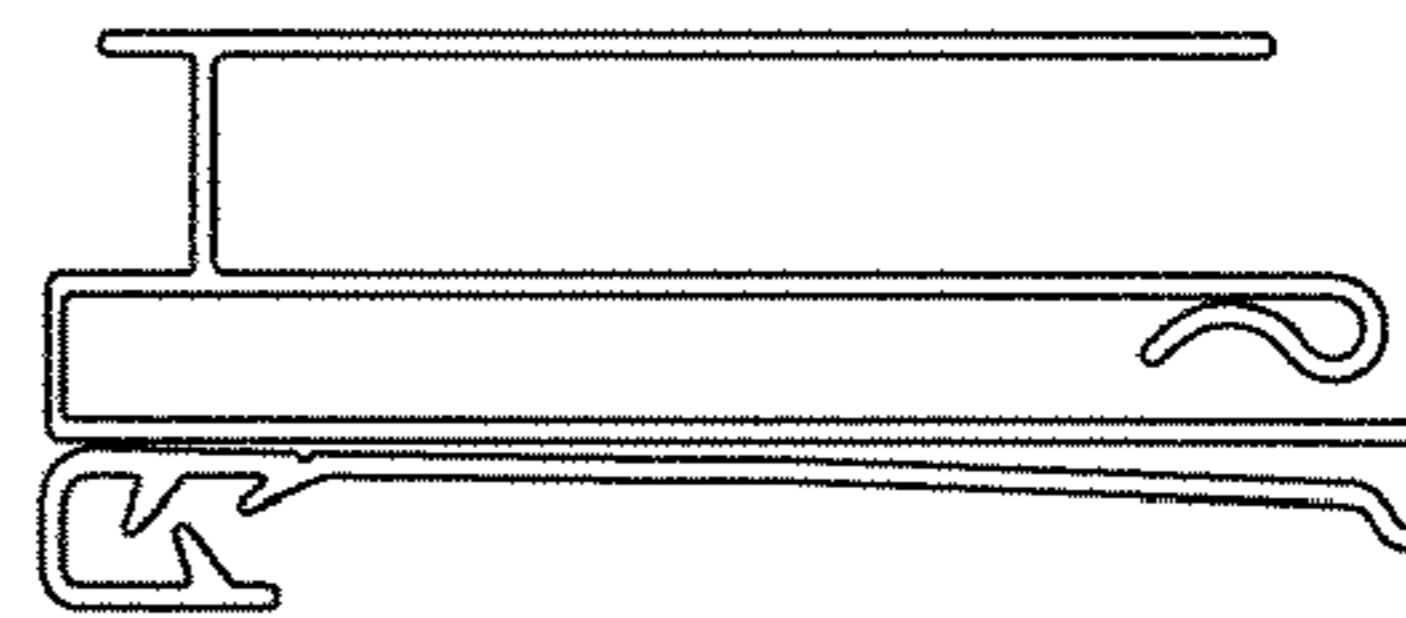

FIG. 2

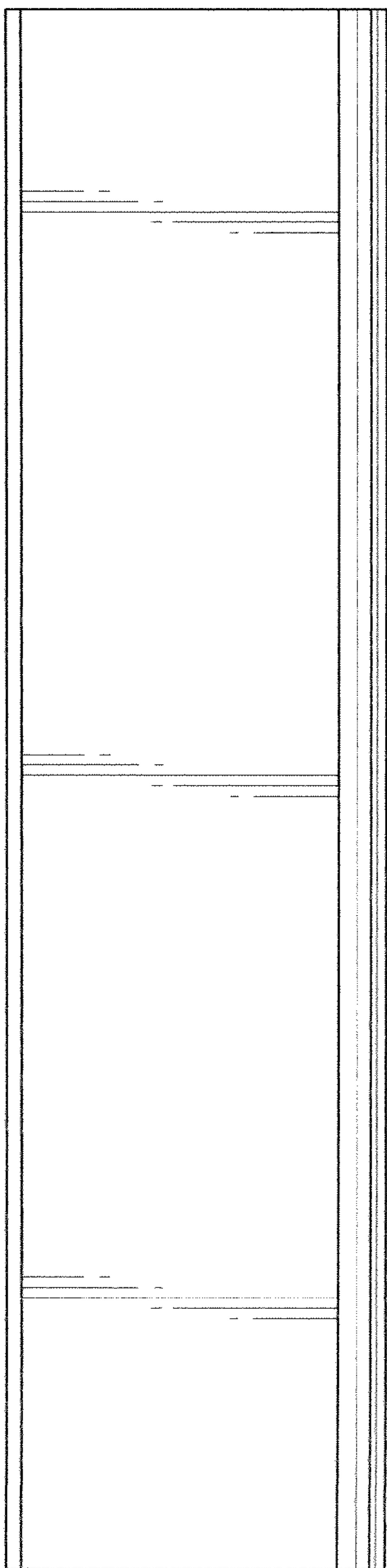

FIG. 4

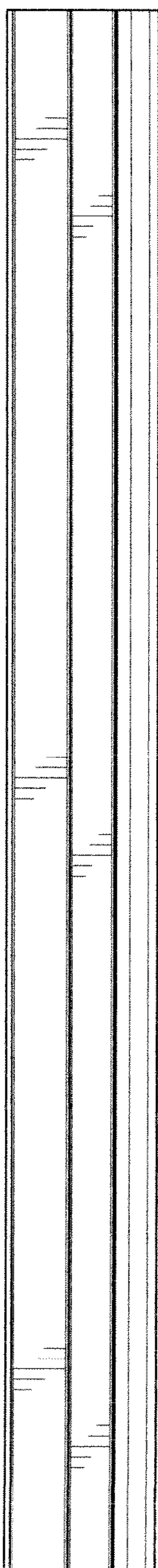

FIG. 5

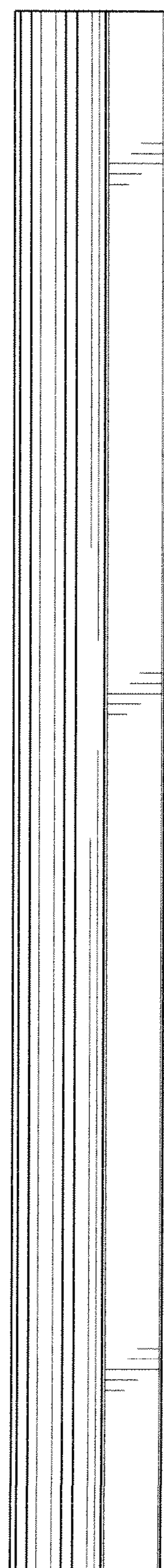

FIG. 6

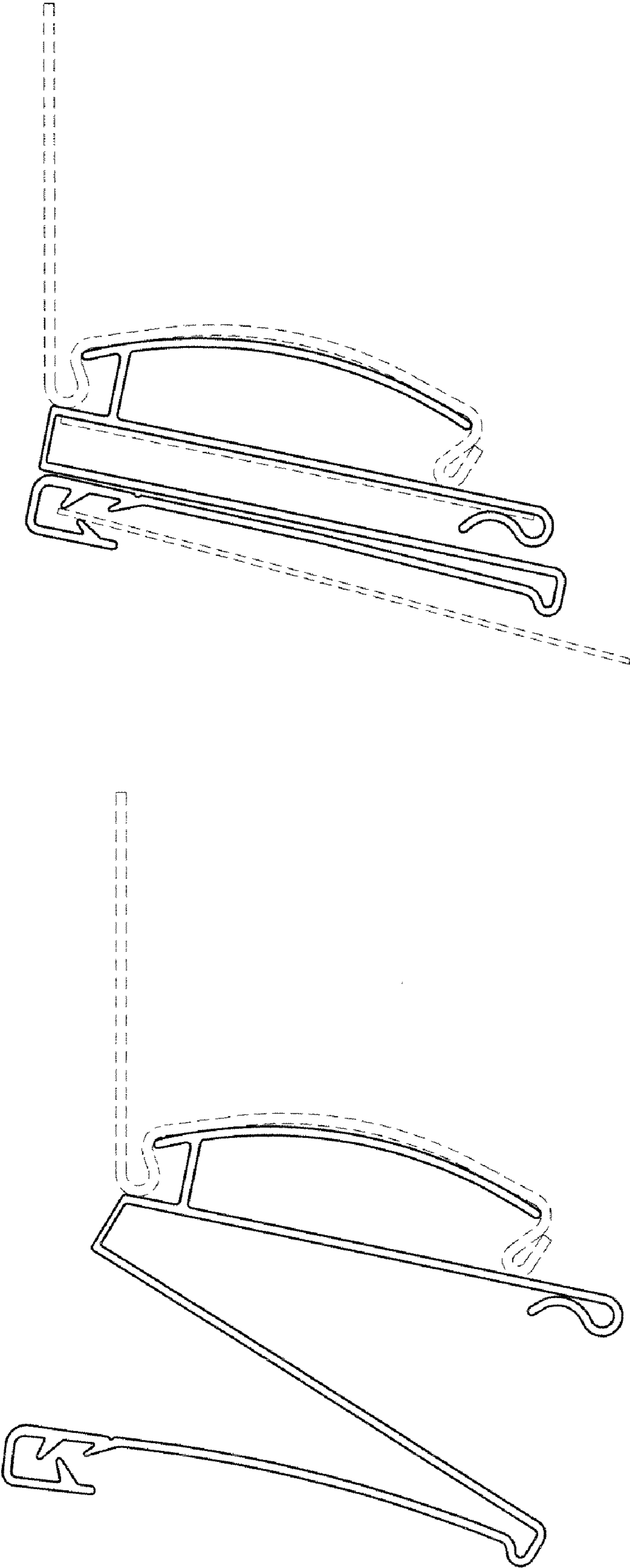

FIG. 8

FIG. 7