



US00D606954S

(12) **United States Design Patent**
Yamaguchi

(10) **Patent No.:** **US D606,954 S**

(45) **Date of Patent:** **** Dec. 29, 2009**

(54) **TELEVISION RECEIVER**

(75) Inventor: **Takahiro Yamaguchi**, Chiyoda-ku (JP)

(73) Assignee: **Mitsubishi Electric Corporation**,
Tokyo (JP)

(**) Term: **14 Years**

(21) Appl. No.: **29/340,336**

(22) Filed: **Jul. 16, 2009**

(30) **Foreign Application Priority Data**

Apr. 3, 2009 (JP) 2009-007798

(51) **LOC (9) Cl.** **14-03**

(52) **U.S. Cl.** **D14/128; D14/126**

(58) **Field of Classification Search** D14/125-134,
D14/239, 371, 136, 374-377, 440, 450, 448,
D14/336, 342; 312/7.2; 348/836, 838, 180,
348/184, 325, 739; 341/12; 248/917-924,
248/465; 345/104, 133, 156, 168, 87, 173;
720/605, 669, 600, 655; 369/99, 197; 455/344,
455/347; D21/329, 515, 577, 622, 333, 433,
D21/448, 452, 450, 331; D6/477, 479, 300;
273/148 B; 446/484, 175, 356; D10/15,
D10/26

See application file for complete search history.

(56) **References Cited**

U.S. PATENT DOCUMENTS

D470,466 S * 2/2003 Forlenza et al. D14/128

D545,786 S * 7/2007 Arai et al. D14/128
D563,336 S * 3/2008 Shih et al. D14/126
D564,472 S * 3/2008 Won et al. D14/128
D566,072 S * 4/2008 Yamaguchi D14/126
D571,325 S * 6/2008 Fujiki D14/128
D574,345 S * 8/2008 Katsumata D14/128

* cited by examiner

Primary Examiner—Raphael Barkai

(74) *Attorney, Agent, or Firm*—Sughrue Mion, PLLC

(57) **CLAIM**

The ornamental design for a television receiver, as shown and described.

DESCRIPTION

FIG. 1 is a front, top and right side perspective view of a television receiver, showing my new design;

FIG. 2 is a front elevational view thereof;

FIG. 3 is a rear elevational view thereof;

FIG. 4 is a top plan view thereof;

FIG. 5 is a bottom plan view thereof;

FIG. 6 is a left side elevational view thereof;

FIG. 7 is a right side elevational view thereof;

FIG. 8 is a cross-sectional view thereof; taken along line 8—8 of FIG. 2, with the internal system omitted; and,

FIG. 9 is a cross-sectional view thereof; taken along line 9—9 of FIG. 2, with the internal system omitted.

1 Claim, 4 Drawing Sheets

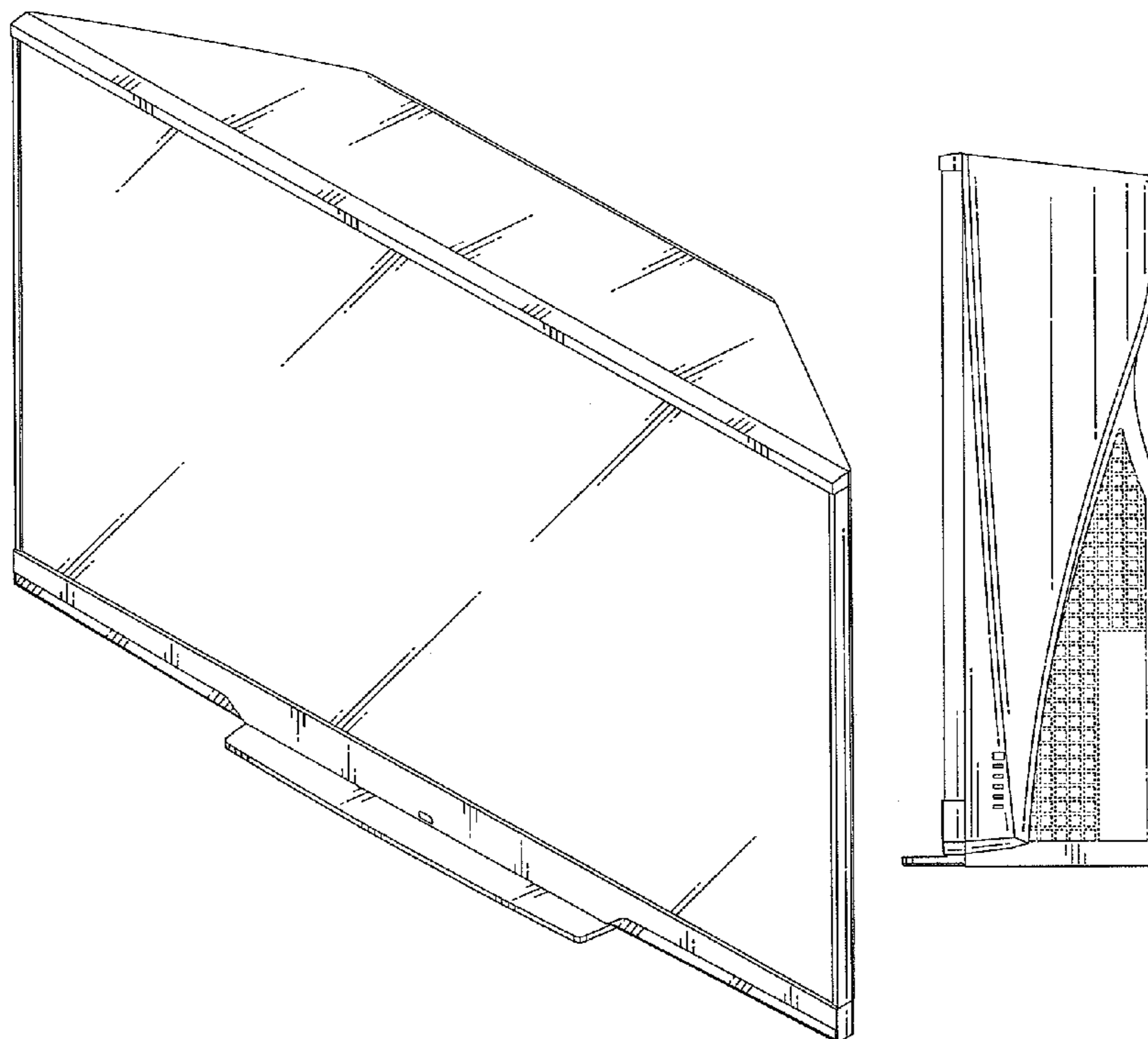

FIG. 1

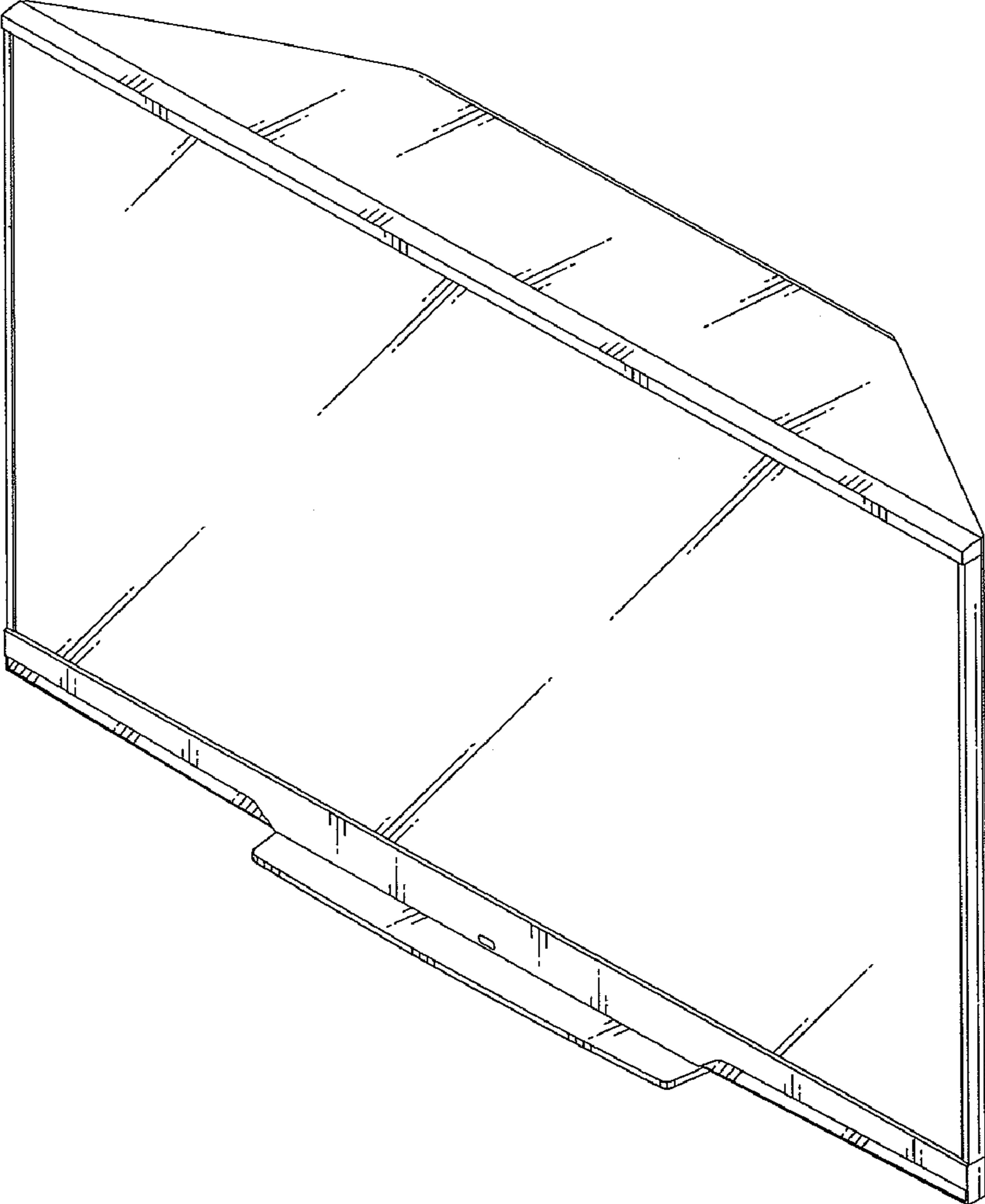

FIG.2

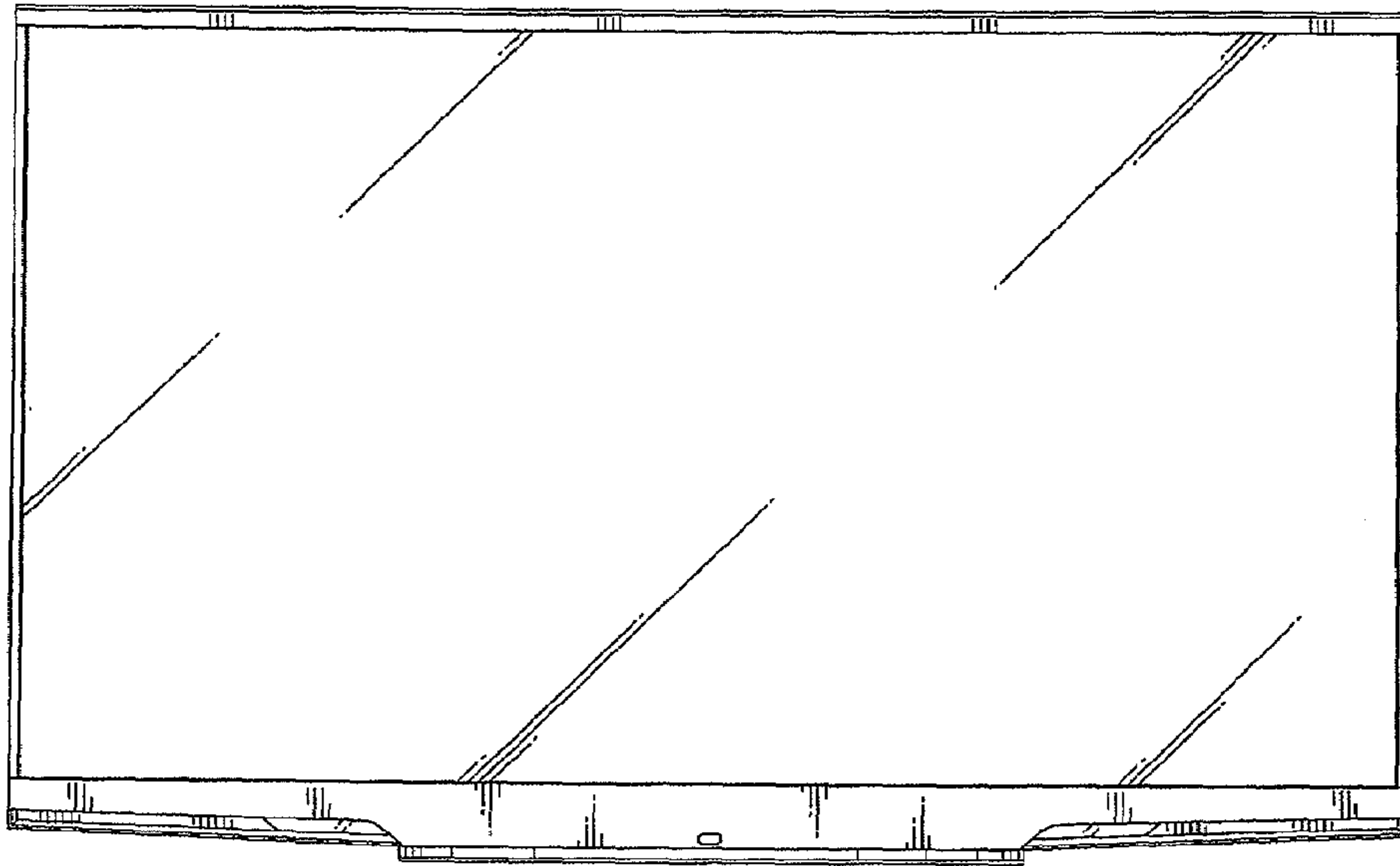

FIG.3

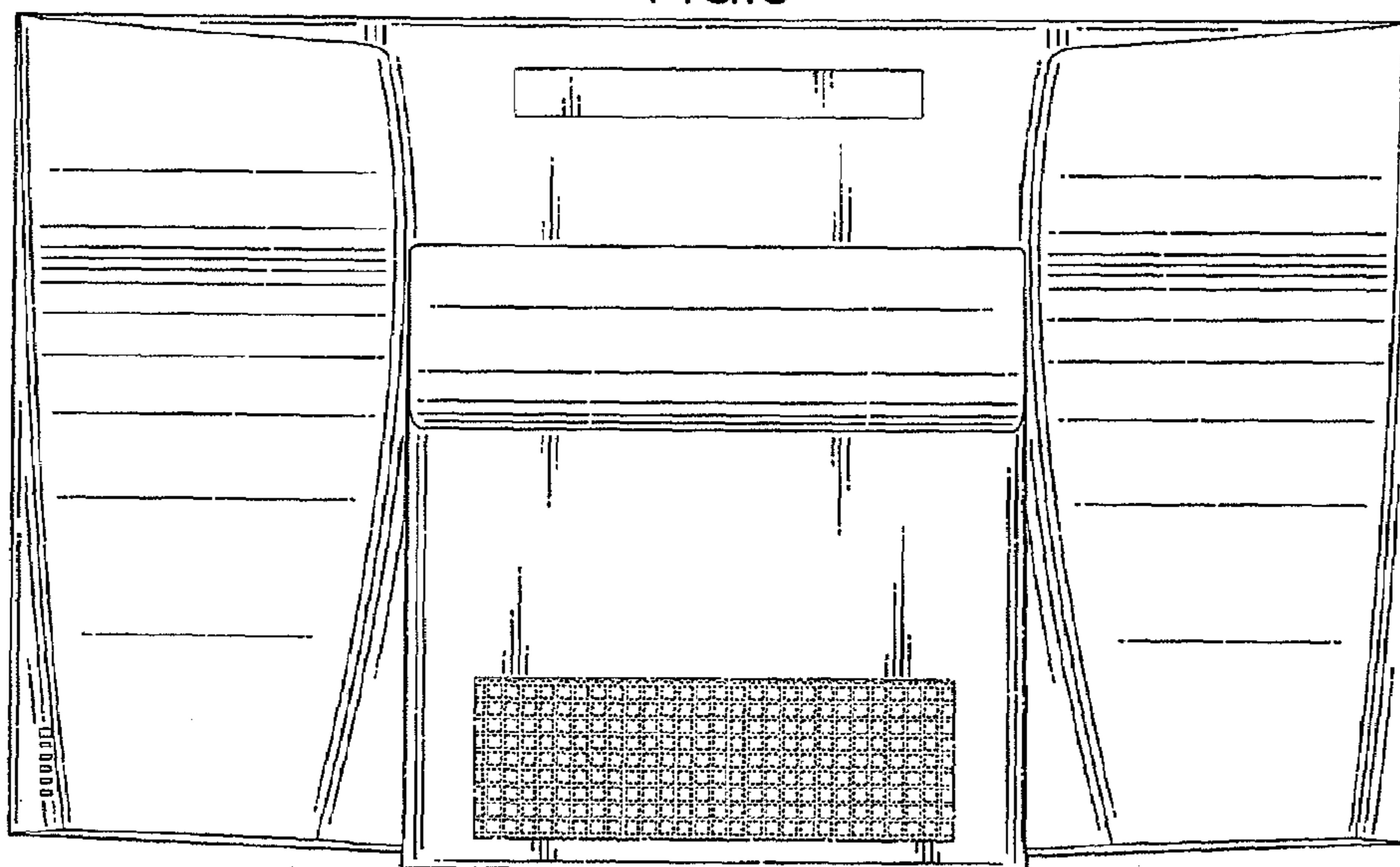

FIG.4

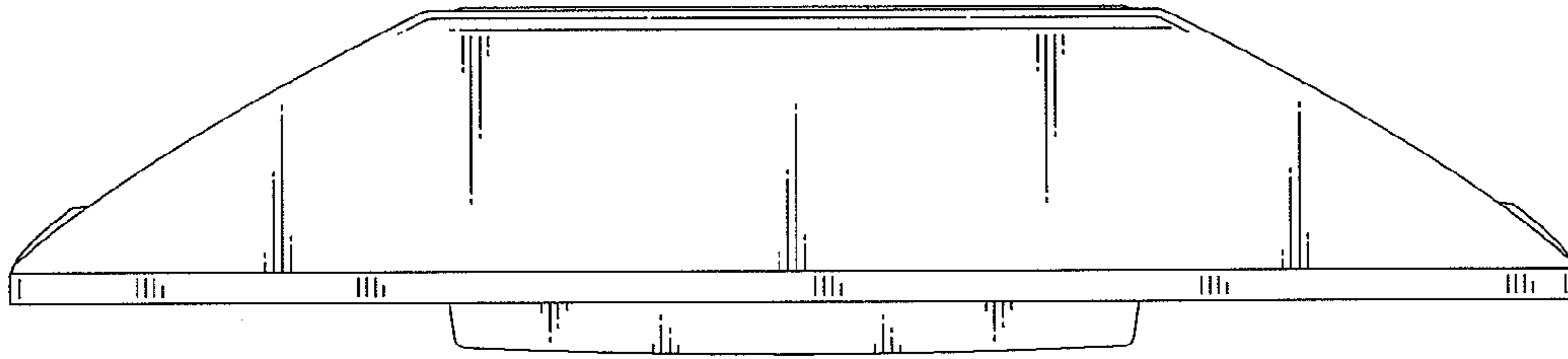

FIG.5

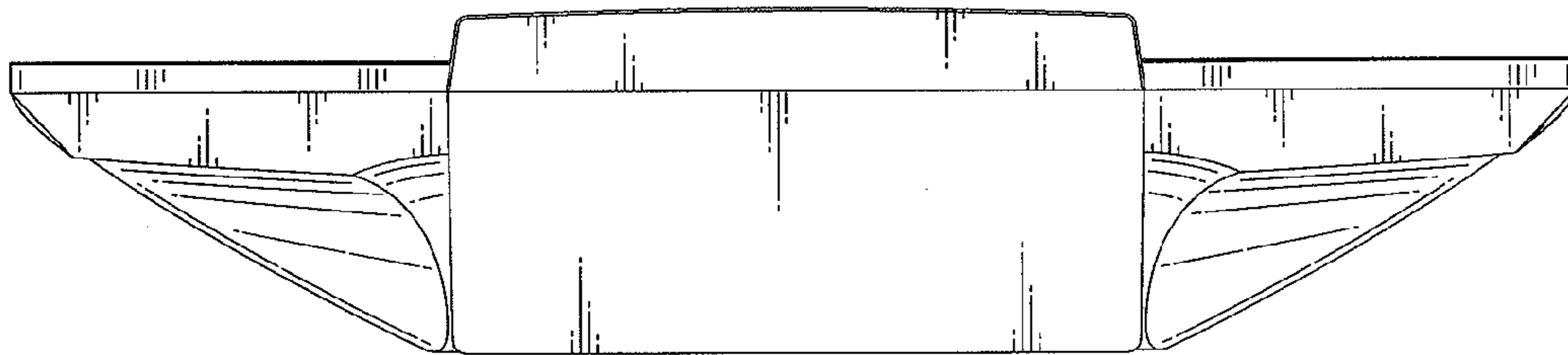

FIG.6

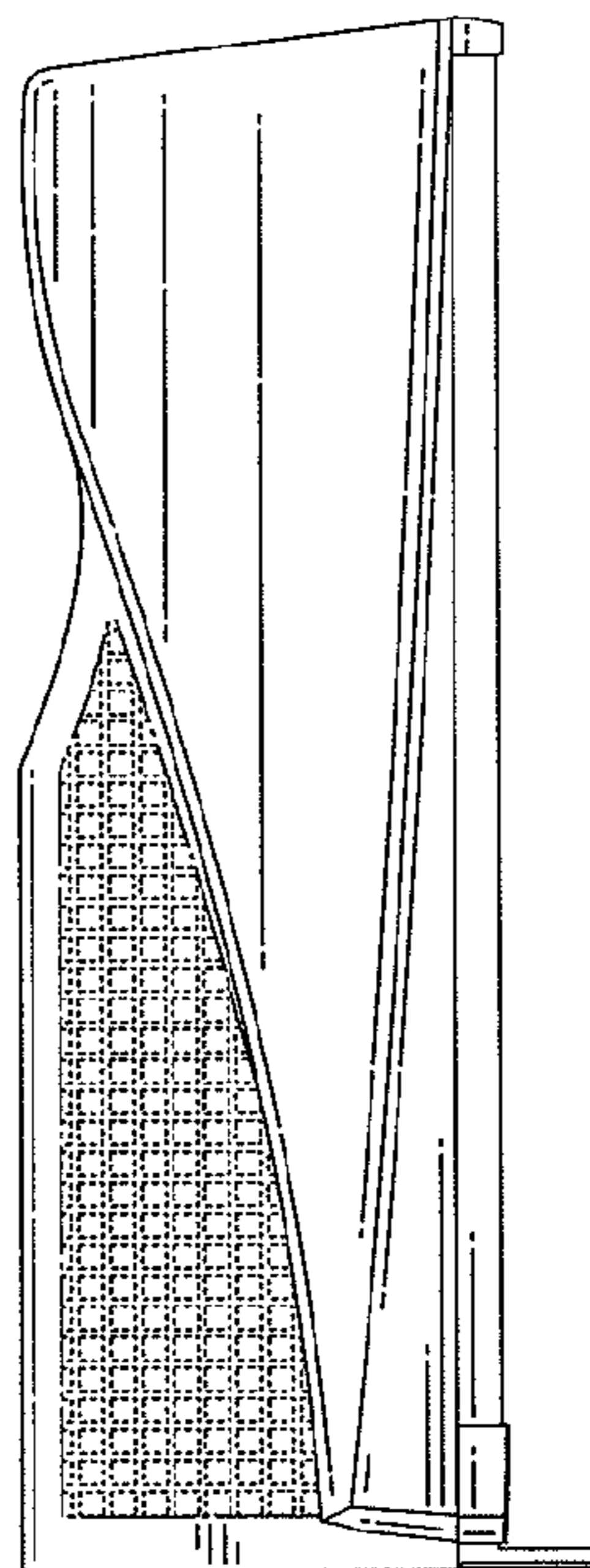

FIG.7

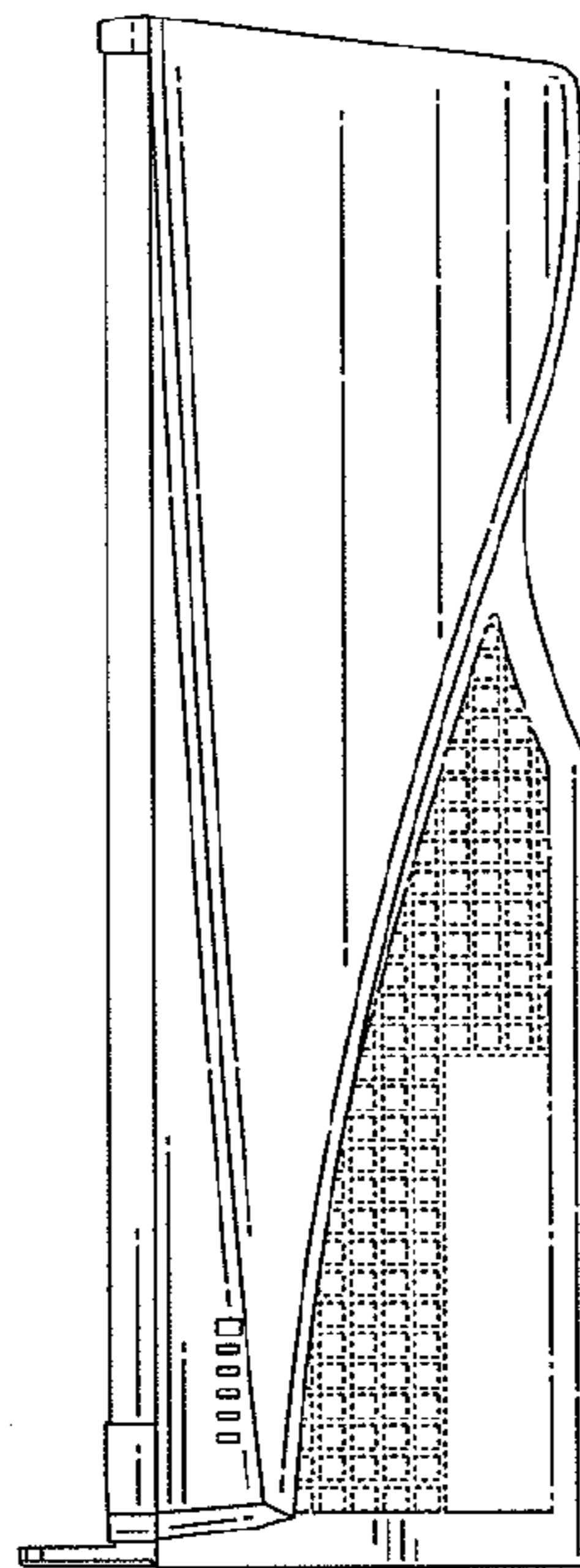

FIG.8

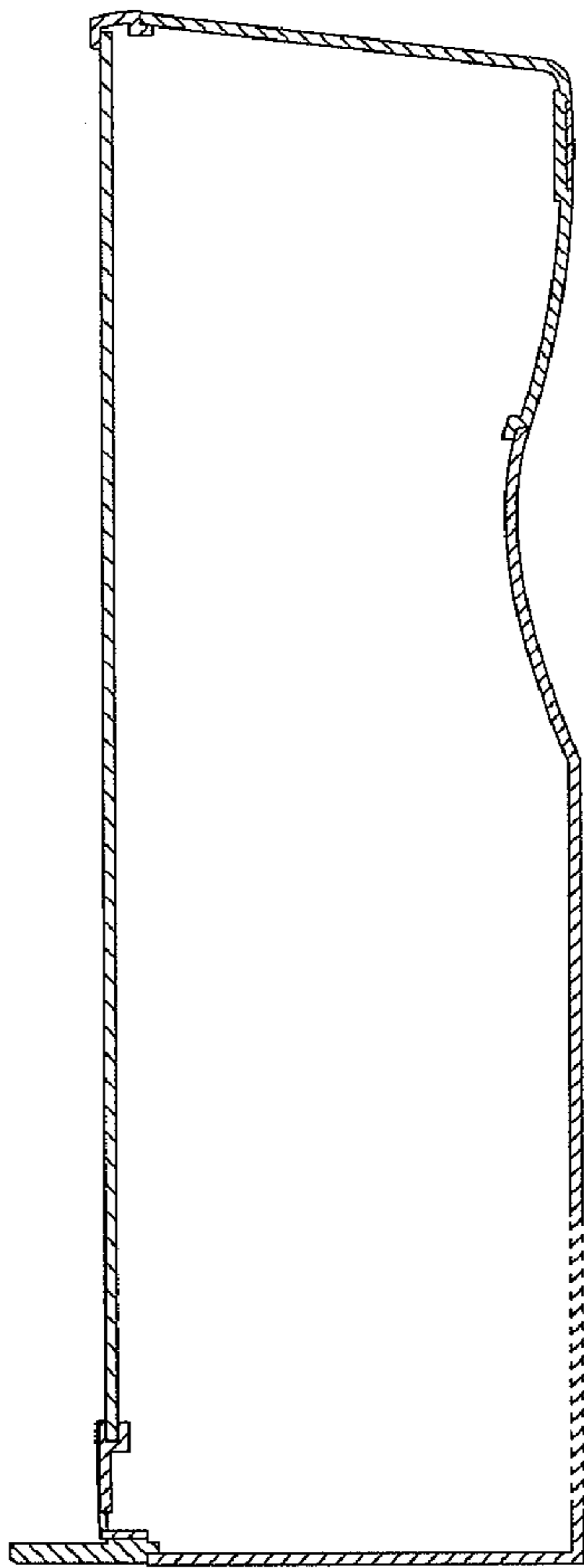

FIG.9

