



US00D606912S

(12) **United States Design Patent**
Sahs

(10) **Patent No.:** **US D606,912 S**

(45) **Date of Patent:** **** Dec. 29, 2009**

(54) **BUMPER FOR VEHICLE**

(75) Inventor: **John Sahs**, Komae (JP)

(73) Assignee: **Nissan Motor Co., Ltd.**, Yokohama-shi (JP)

(**) Term: **14 Years**

(21) Appl. No.: **29/332,228**

(22) Filed: **Feb. 11, 2009**

(30) **Foreign Application Priority Data**

Sep. 1, 2008 (JP) 2008-022410

(51) **LOC (9) Cl.** **12-16**

(52) **U.S. Cl.** **D12/169**

(58) **Field of Classification Search** D12/169,
D12/196, 171, 216, 163, 86, 90-92; 293/102,
293/113, 115, 117, 120; 296/180.1, 180.2
See application file for complete search history.

(56) **References Cited**

U.S. PATENT DOCUMENTS

D584,201 S * 1/2009 Kamimura D12/169
D591,211 S * 4/2009 Hayashi et al. D12/169
D592,573 S * 5/2009 Asakura et al. D12/169

* cited by examiner

Primary Examiner—Melody N Brown
(74) *Attorney, Agent, or Firm*—Foley & Lardner LLP

(57) **CLAIM**

The ornamental design for a bumper for vehicle, as shown and described.

DESCRIPTION

FIG. 1 is a perspective view of a bumper for vehicle;

FIG. 2 is a front view thereof;

FIG. 3 is a rear view thereof;

FIG. 4 is a top plan view thereof;

FIG. 5 is a bottom plan view thereof;

FIG. 6 is a left side view thereof;

FIG. 7 is a right side view thereof;

FIG. 8 is an enlarged sectional view thereof showing the sectioned surface of the portion taken along line 8—8 in FIG. 2;

FIG. 9 is an enlarged sectional view thereof showing the sectioned surface of the portion taken along line 9—9 in FIG. 2; and,

FIG. 10 is an enlarged sectional view thereof showing the sectioned surface of the portion taken along line 10—10 in FIG. 2.

1 Claim, 3 Drawing Sheets

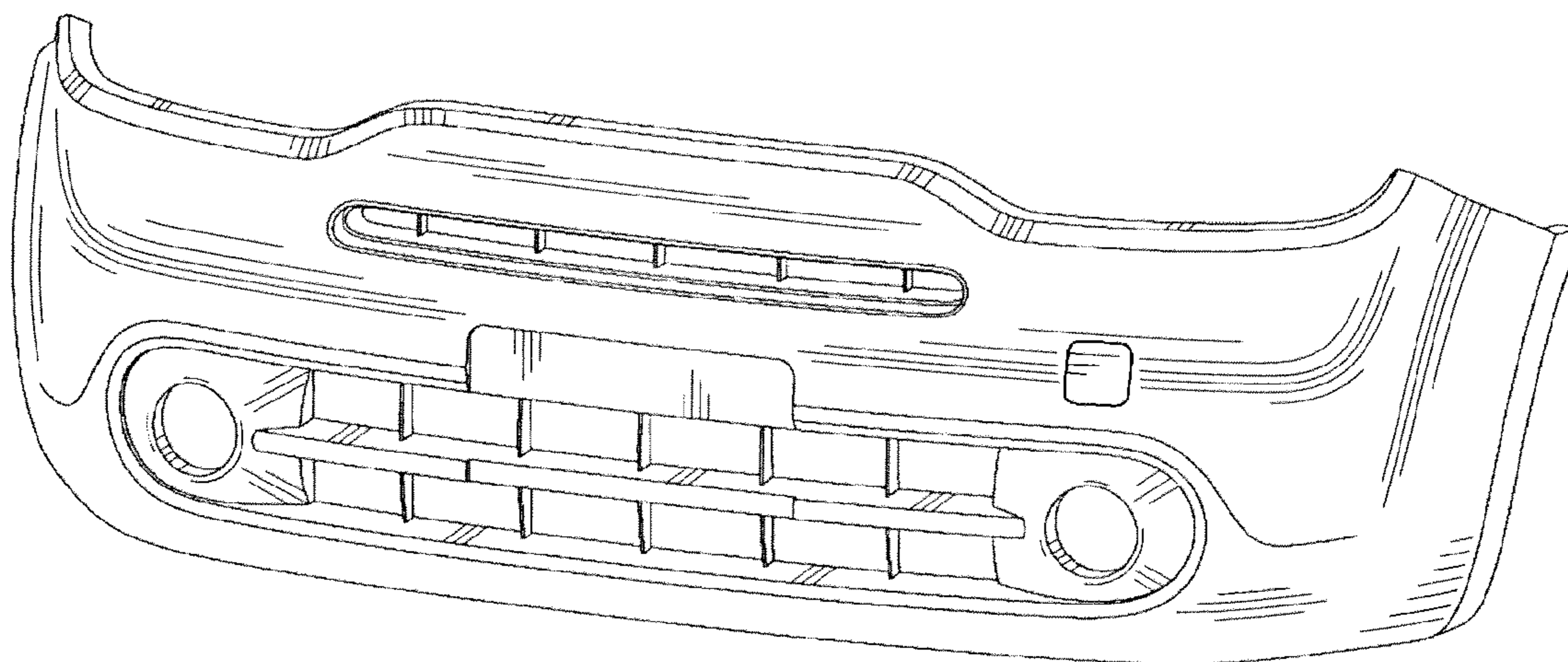

Fig.1

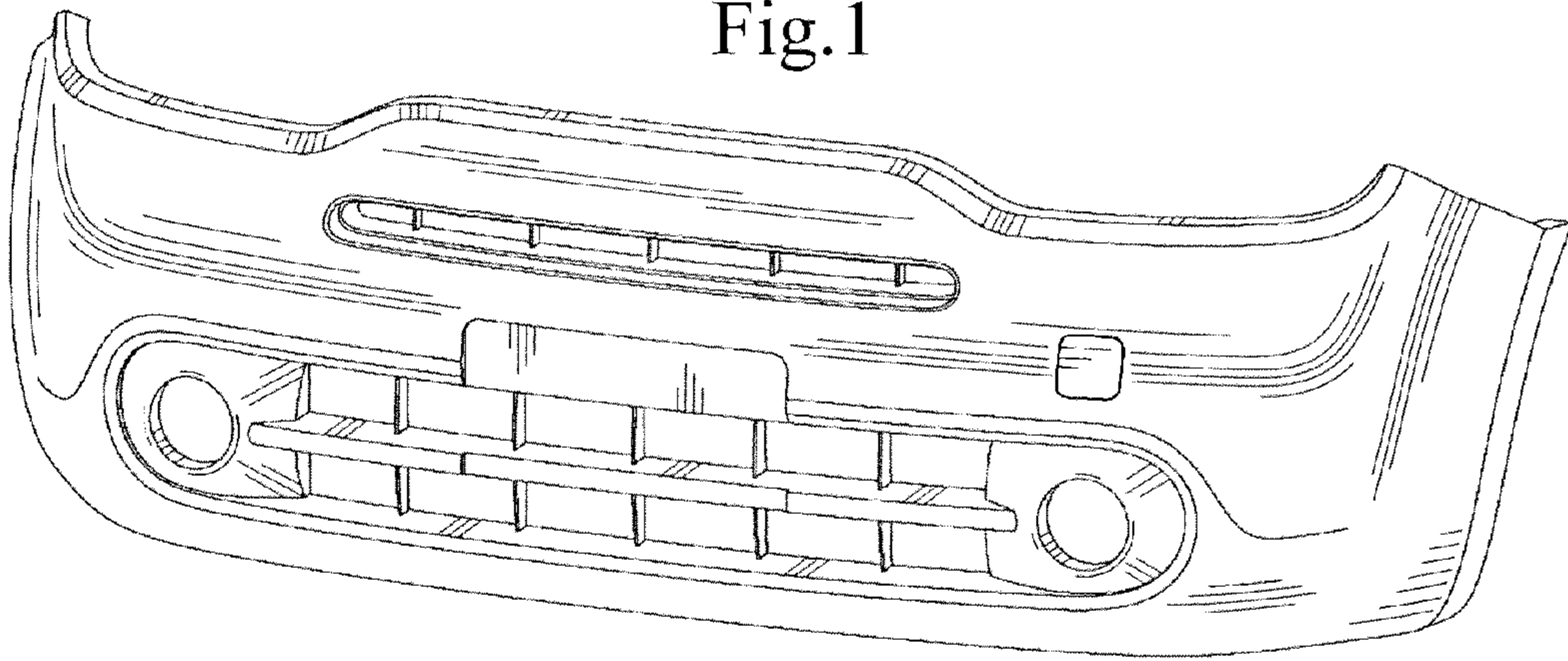

Fig.2

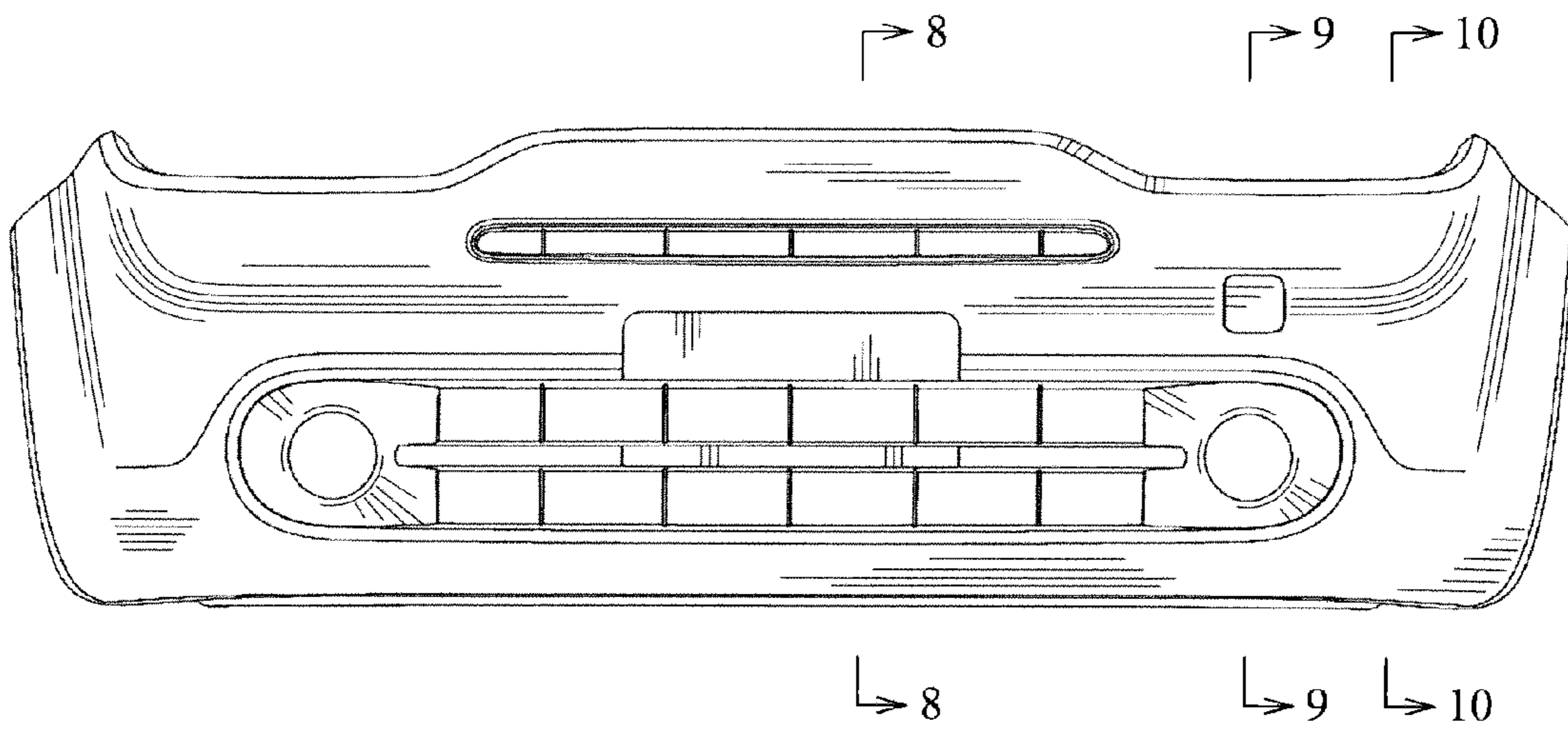
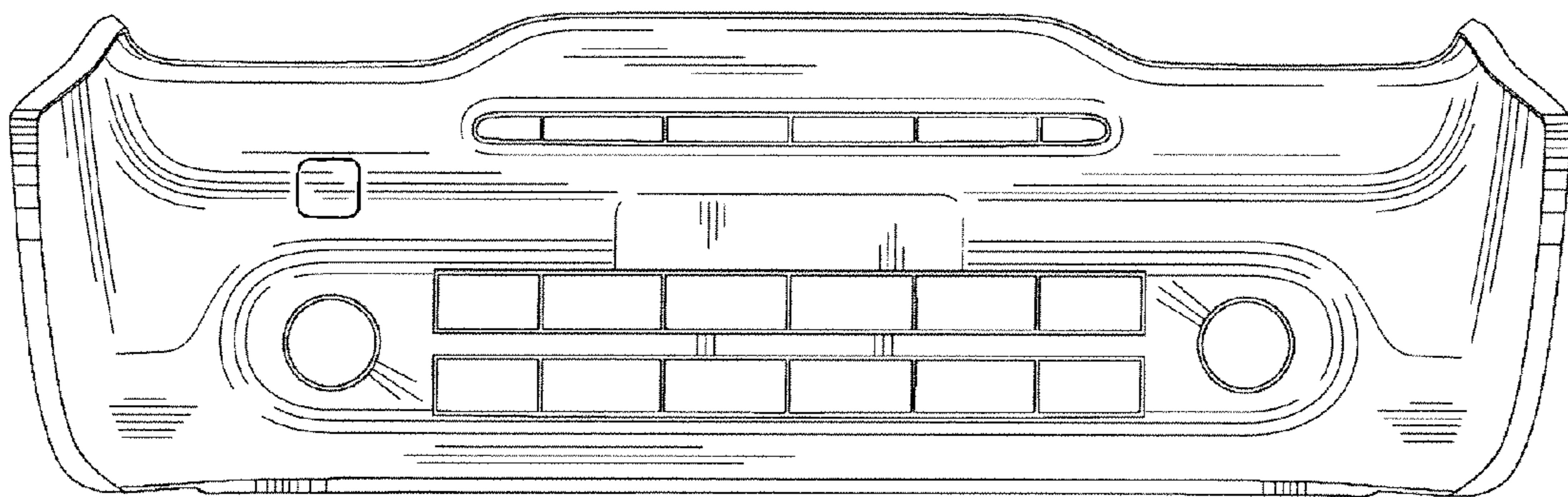

Fig.3



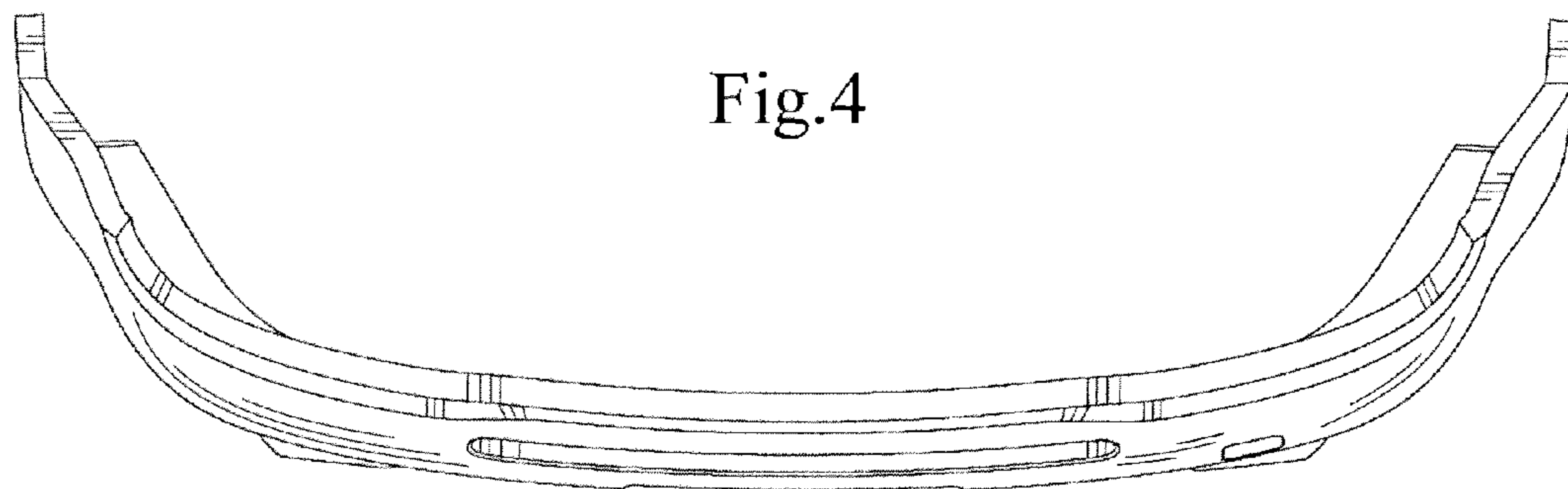

Fig. 4

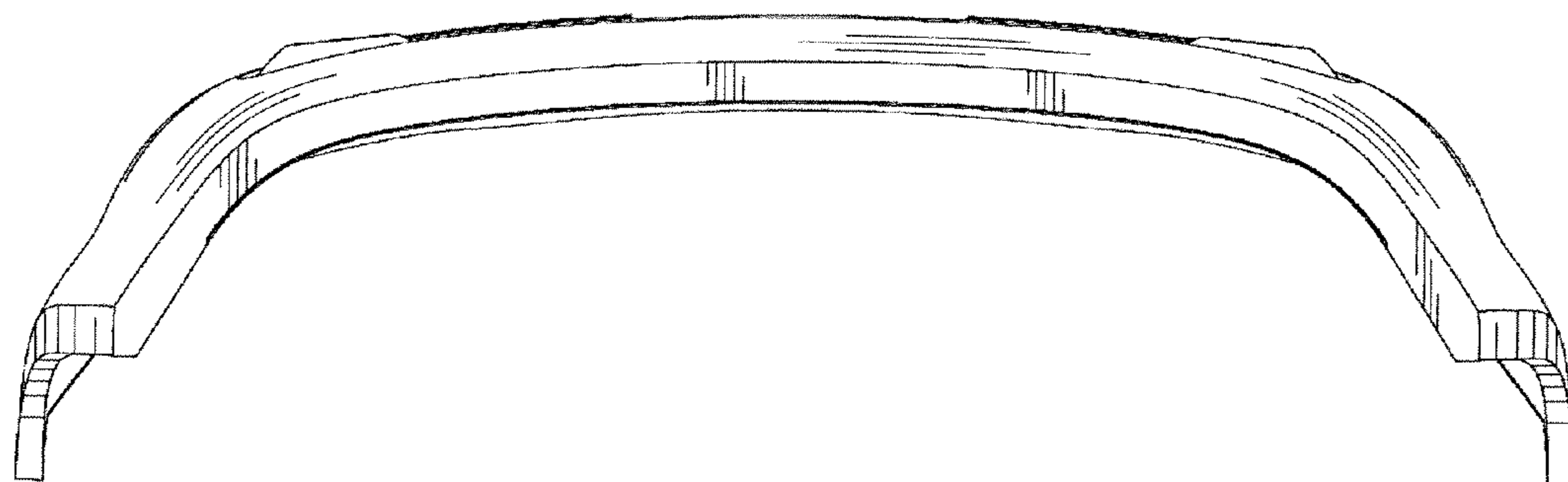

Fig. 5

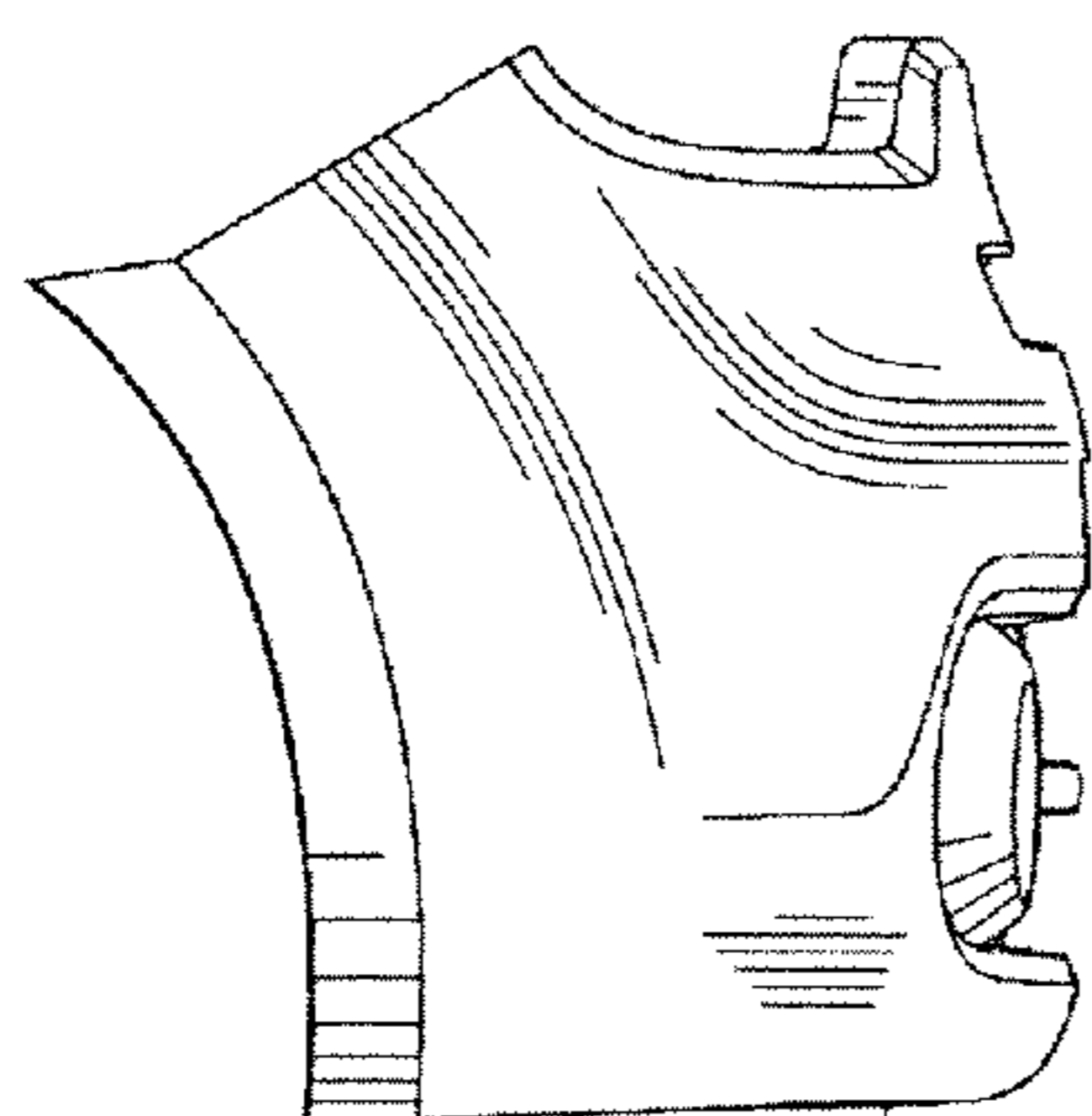

Fig. 6

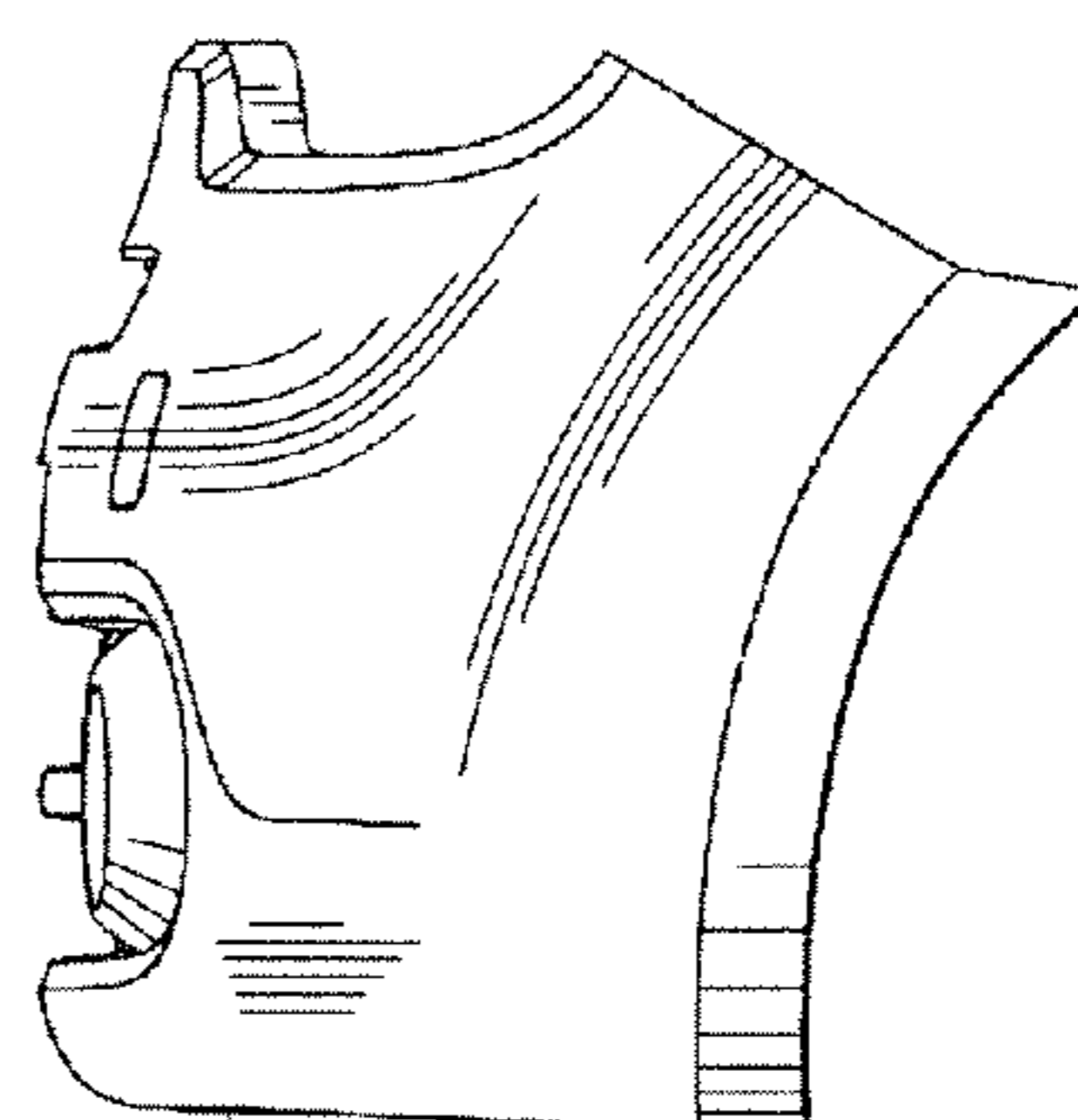

Fig. 7

Fig.8

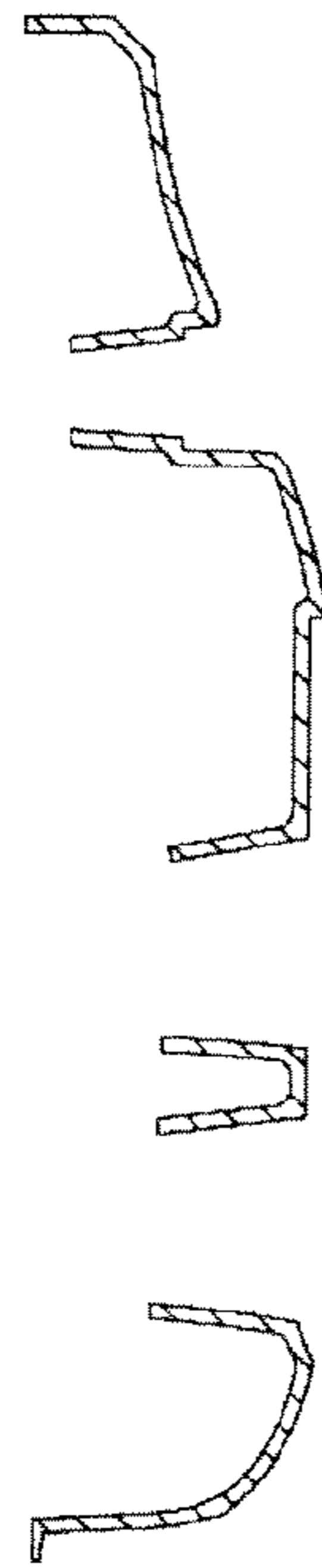

Fig.9

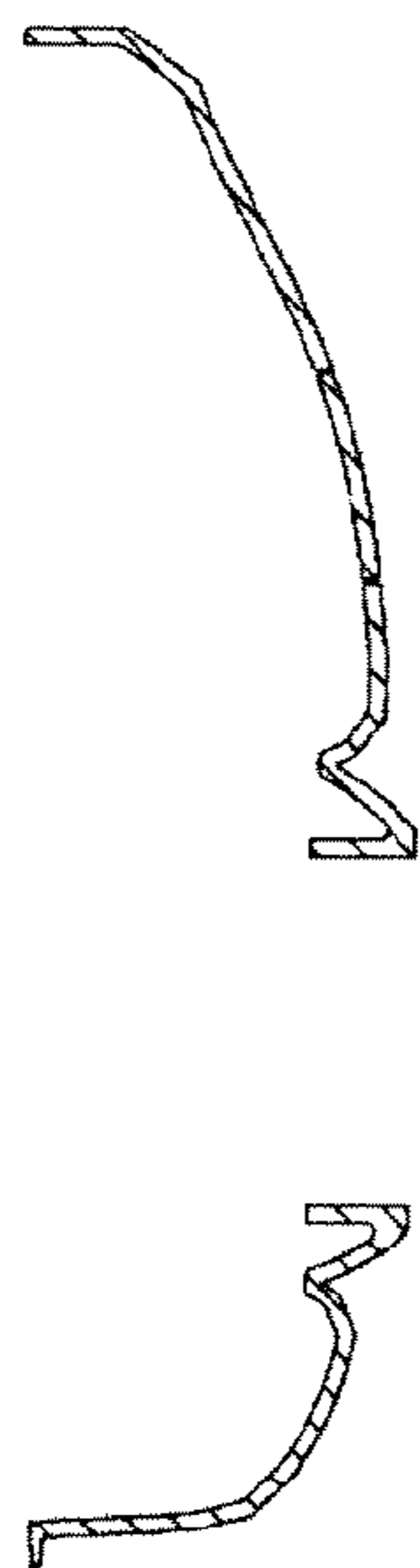

Fig.10

