



US00D606880S

(12) **United States Design Patent**
Kertesz

(10) **Patent No.:** **US D606,880 S**
(45) **Date of Patent:** **** Dec. 29, 2009**

(54) **BOTTLE**

(75) Inventor: **Sandy Kertesz**, Miami, FL (US)

(73) Assignee: **Emeshel LLC**, Miami, FL (US)

(**) Term: **14 Years**

(21) Appl. No.: **29/321,445**

(22) Filed: **Jul. 16, 2008**

(51) **LOC (9) Cl.** **09-01**

(52) **U.S. Cl.** **D9/674; D9/651**

(58) **Field of Classification Search** **D9/600,**
D9/651, 674, 500-504, 516, 552, 565, 572-575;
206/457-458, 527; 215/379-383, 400; 220/890
See application file for complete search history.

(56) **References Cited**

U.S. PATENT DOCUMENTS

| | | | | |
|--------------|--------|----------------|-------|--------|
| D188,566 S * | 8/1960 | Morian | | D9/674 |
| D381,897 S * | 8/1997 | Matthiesen | | D9/529 |
| D407,633 S * | 4/1999 | Jacobs | | D9/674 |
| D475,634 S * | 6/2003 | Cooper | | D9/572 |
| D537,730 S * | 3/2007 | Shimizu et al. | | D9/674 |

* cited by examiner

Primary Examiner—Sandra Morris

(74) *Attorney, Agent, or Firm*—Laurence A. Greenberg;
Werner H. Stemer; Ralph E. Locher

(57) **CLAIM**

The ornamental design for a bottle, as shown and described.

DESCRIPTION

FIG. 1 is a front elevational view of the bottle, showing my new design;

FIG. 2 is a right side elevational view thereof;

FIG. 3 is a rear elevational view thereof;

FIG. 4 is a front top perspective view thereof;

FIG. 5 is a rear top perspective view thereof;

FIG. 6 is a front perspective, exploded view thereof;

FIG. 7 is a bottom perspective, exploded view thereof;

FIG. 8 is a front to perspective view of the bottle without the cap;

FIG. 9 is a perspective view of the cap;

FIG. 10 is a front elevational view of the bottle without the cap;

FIG. 11 is a right side elevational view thereof;

FIG. 12 is a rear elevational view thereof;

FIG. 13 is a rear top perspective view thereof;

FIG. 14 is a top plan view of the bottle;

FIG. 15 is a top plan view of the bottle without the cap; and,

FIG. 16 is a bottom plan view of the bottle.

1 Claim, 7 Drawing Sheets



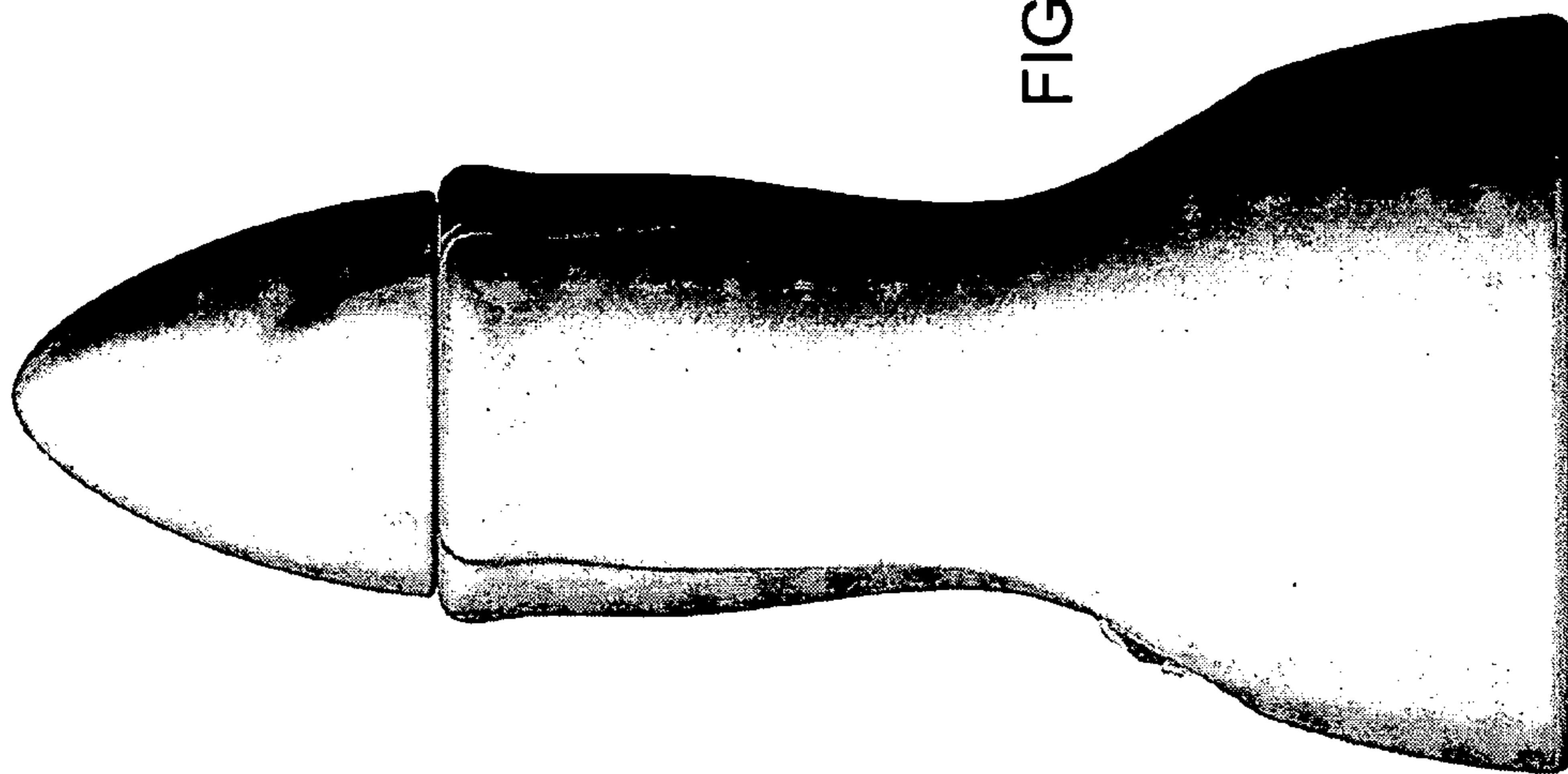

FIG. 2

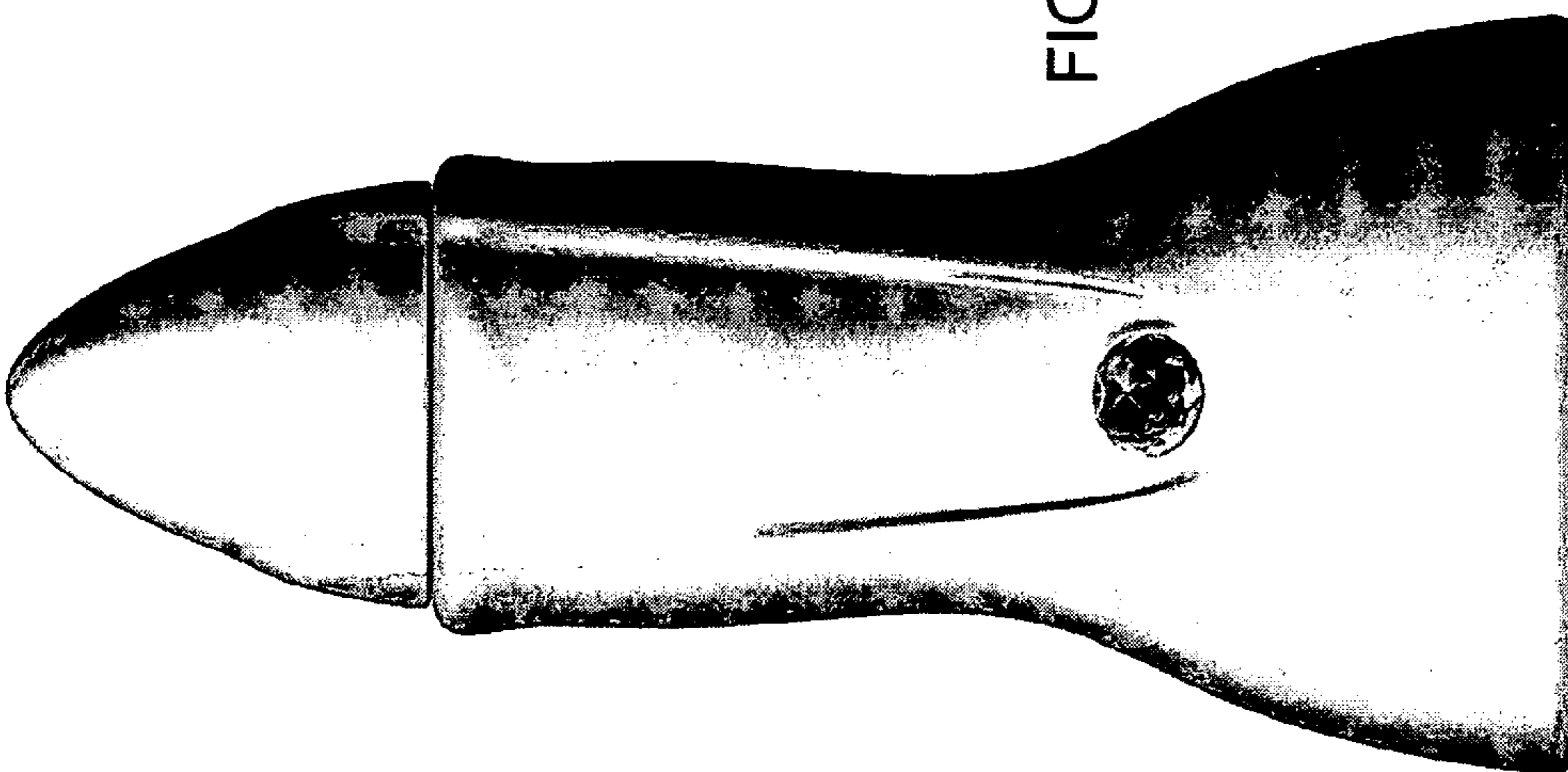

FIG. 1

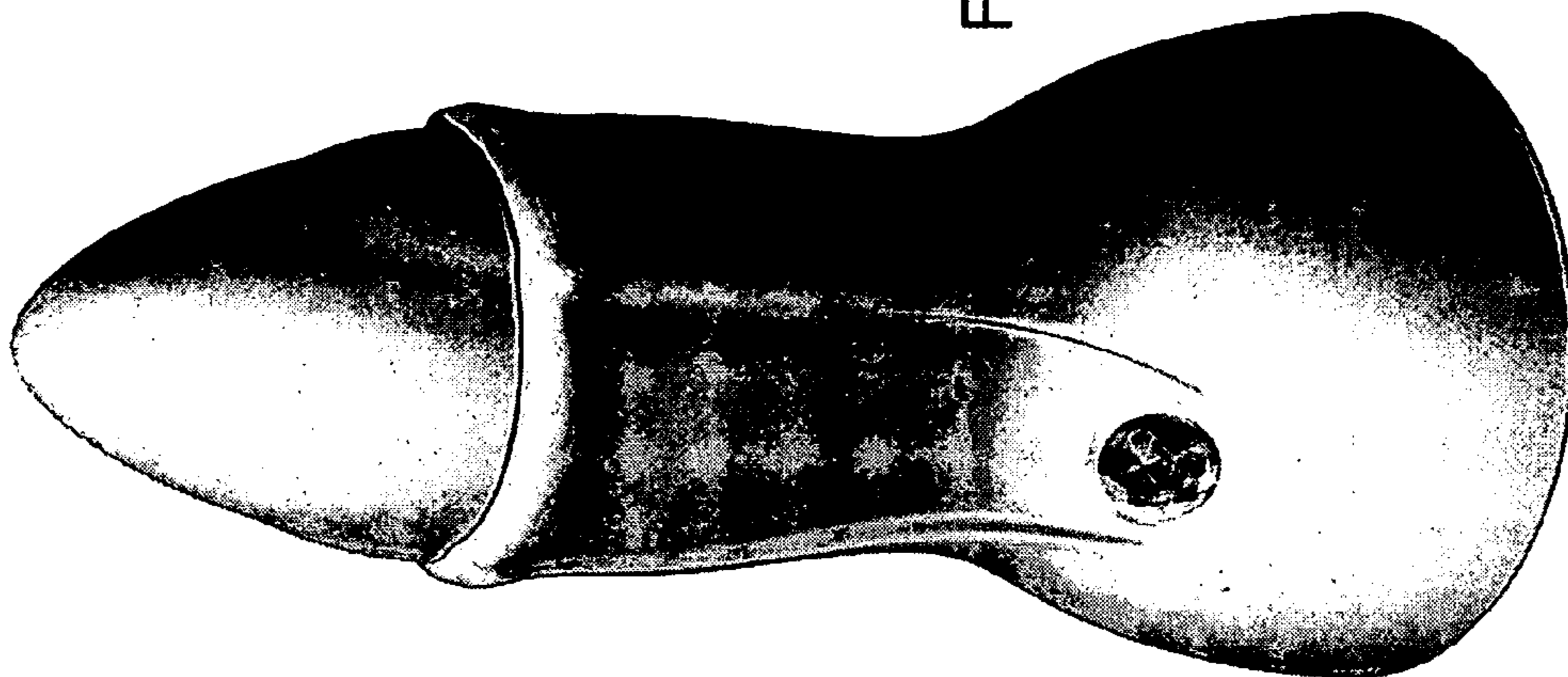

FIG. 4

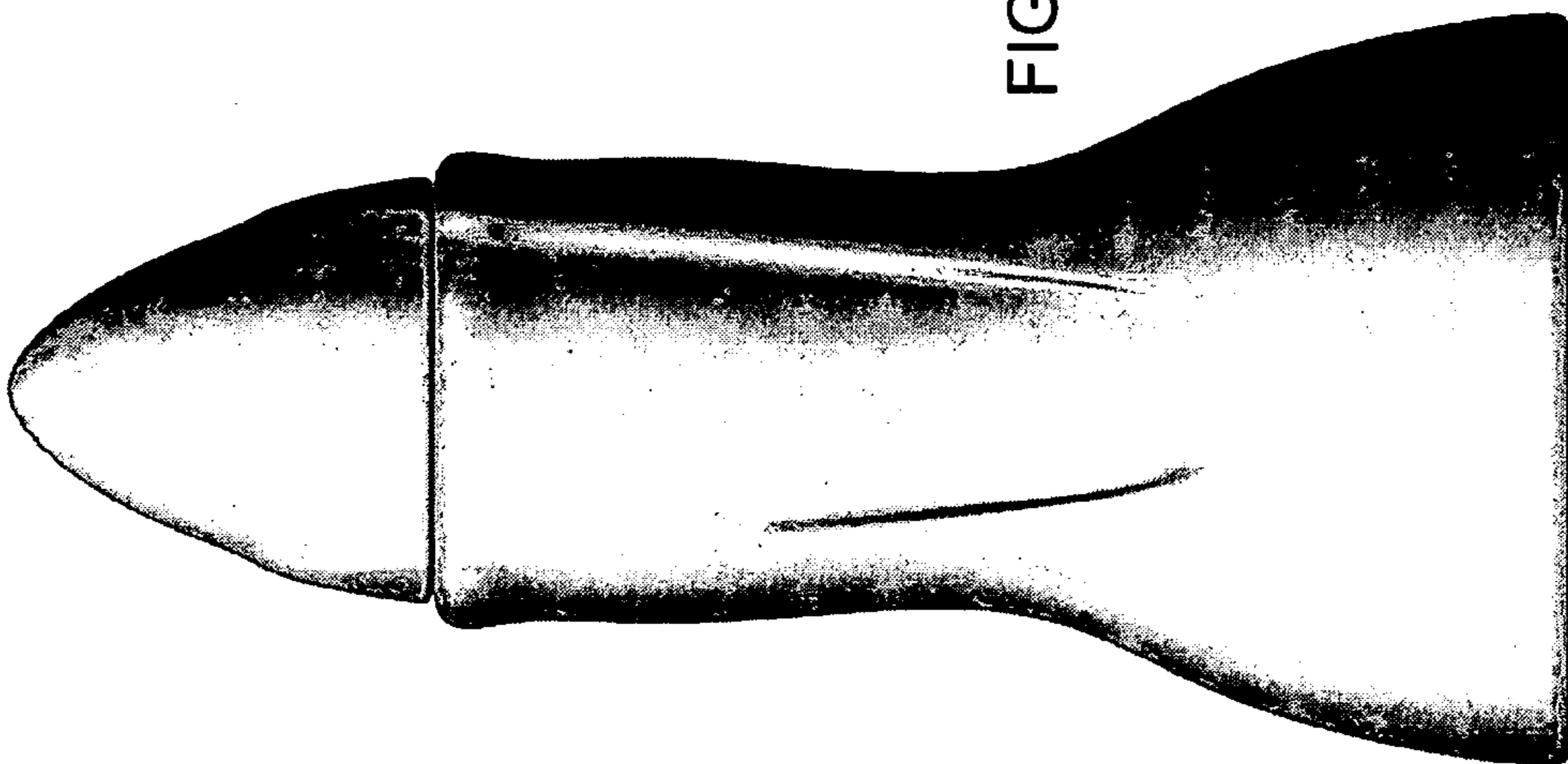

FIG. 3

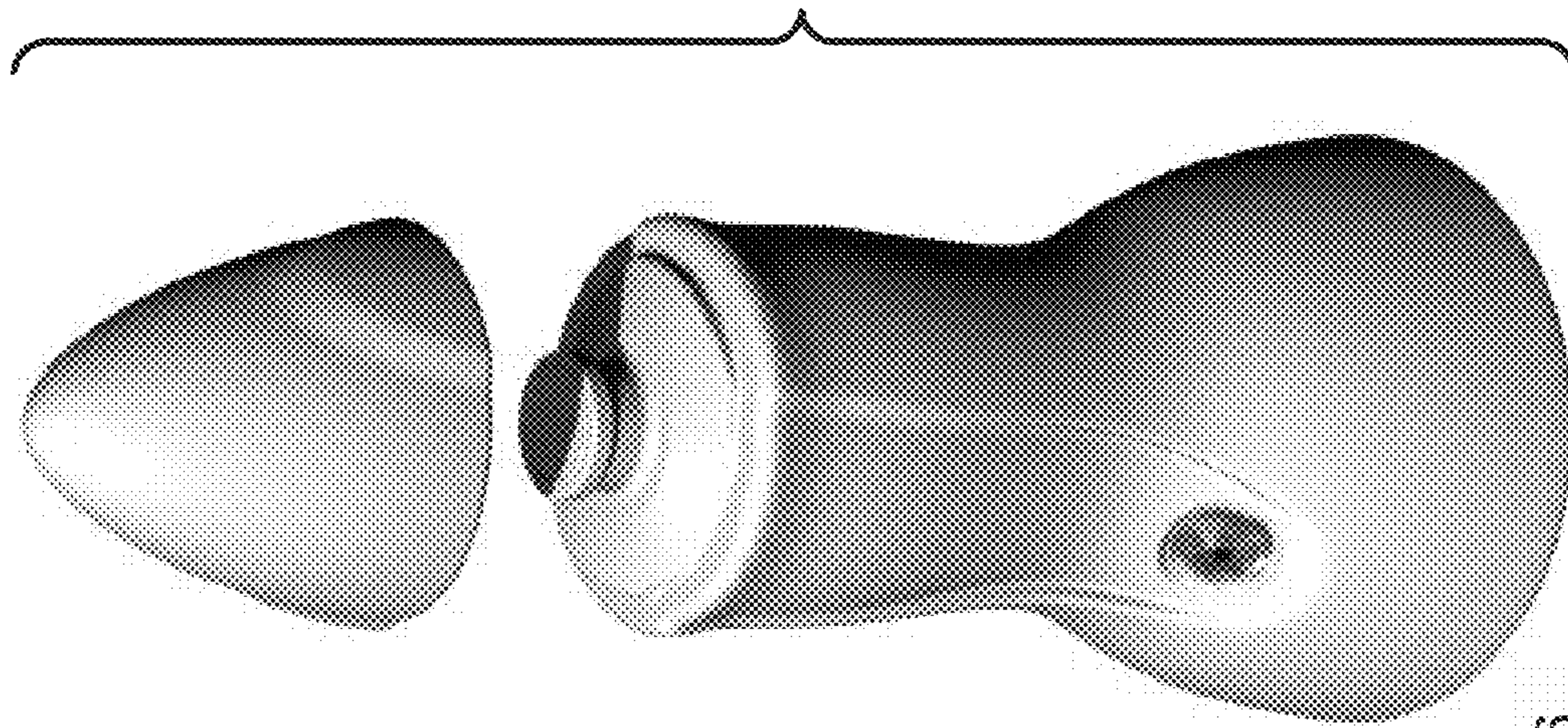

FIG. 6

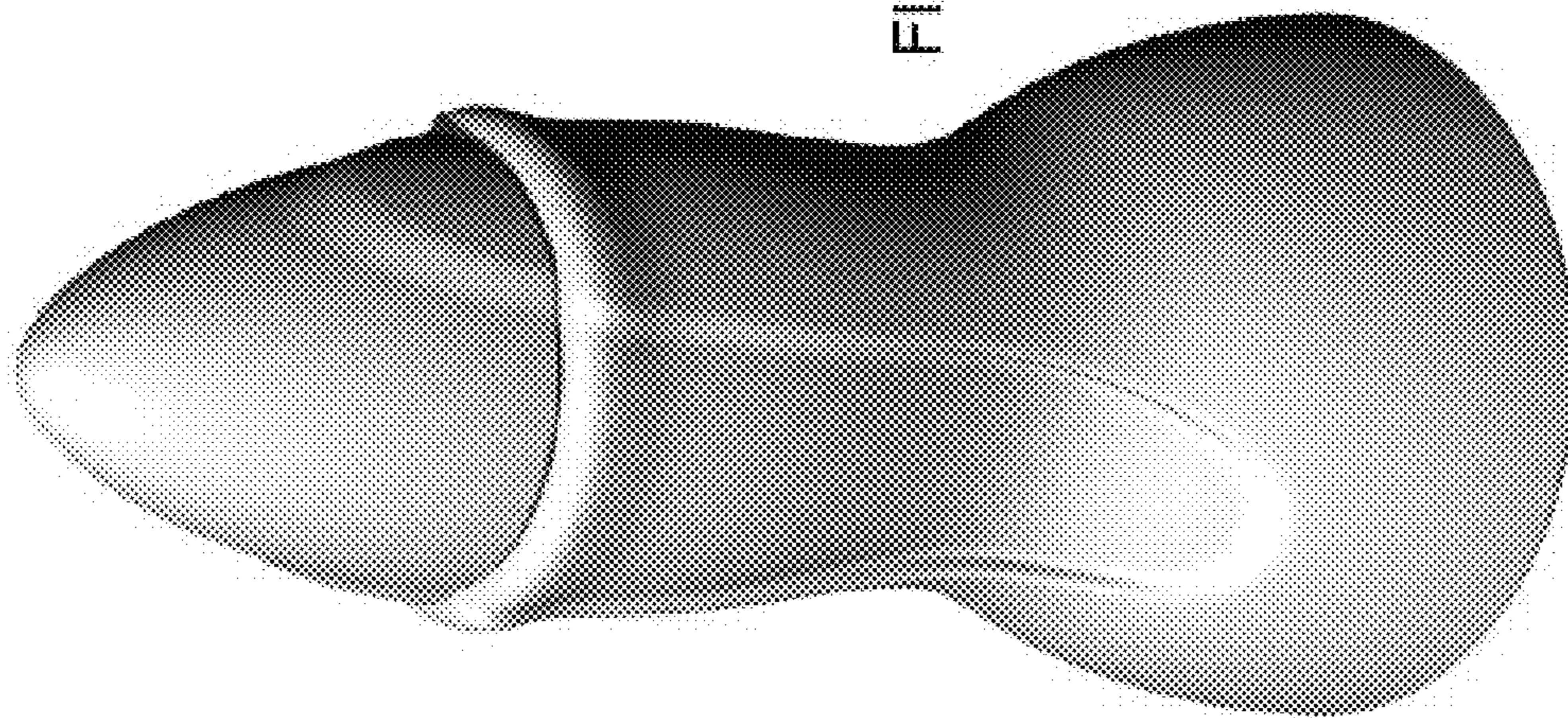

FIG. 5

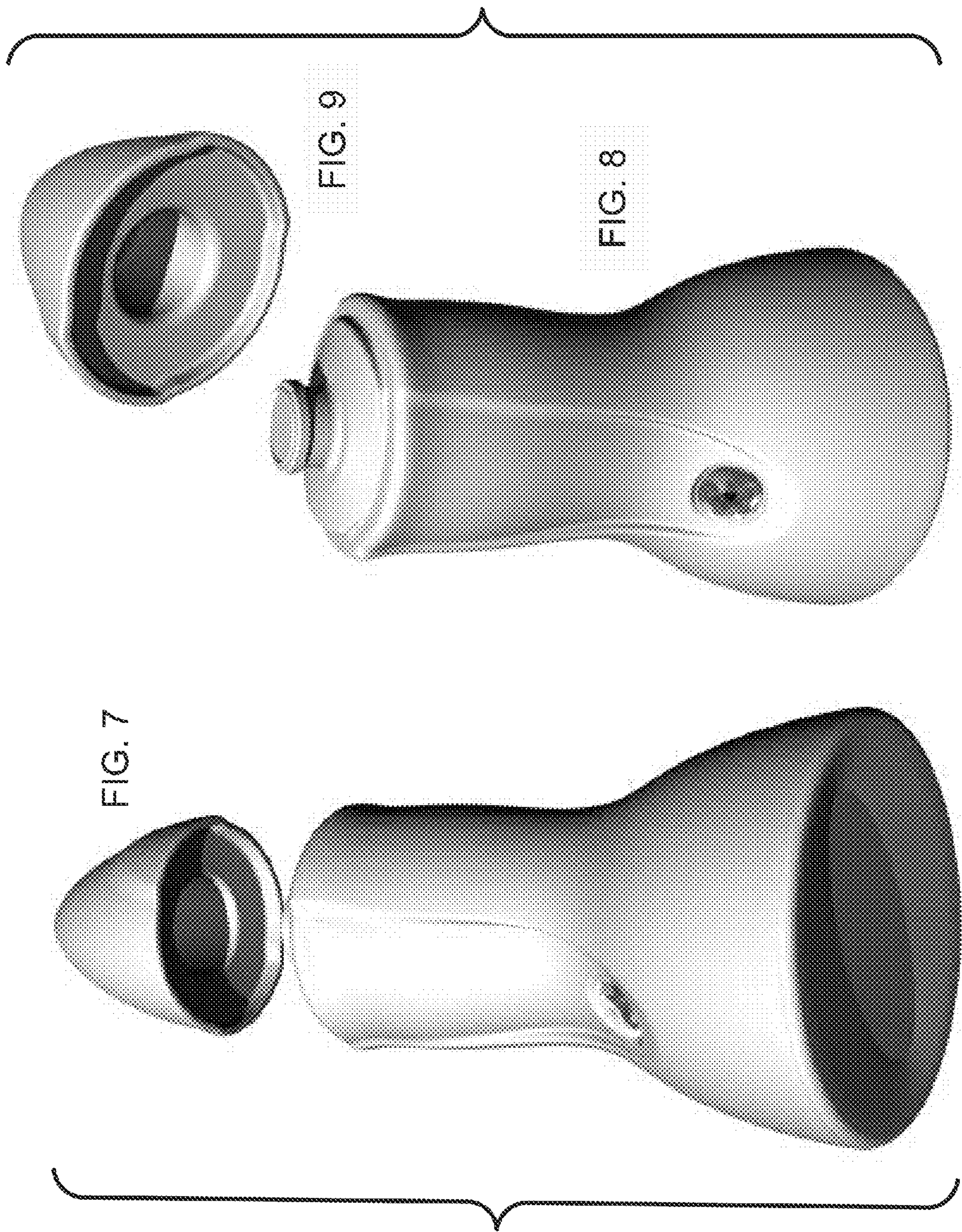

FIG. 11

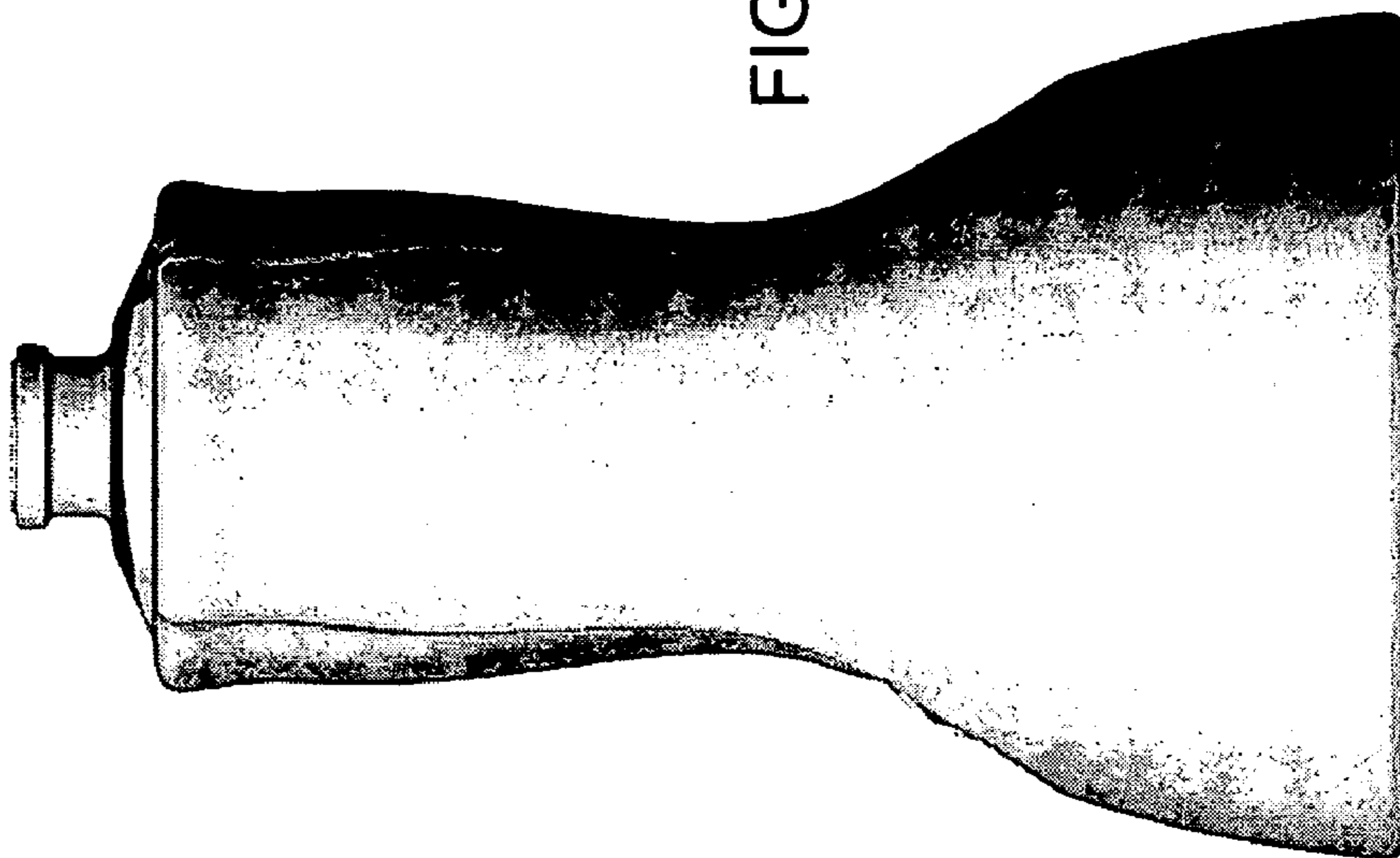

FIG. 10

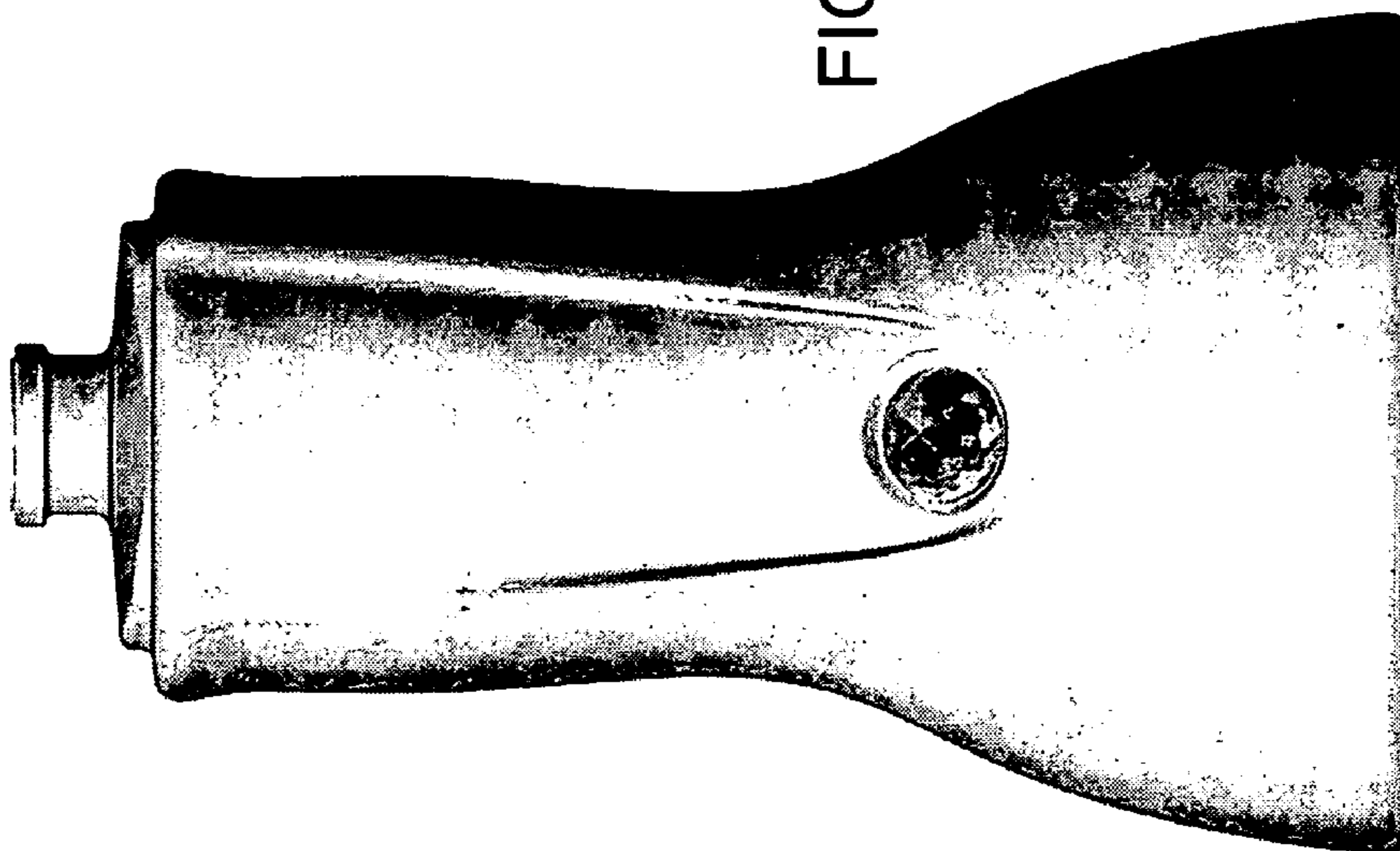



FIG. 13



FIG. 12

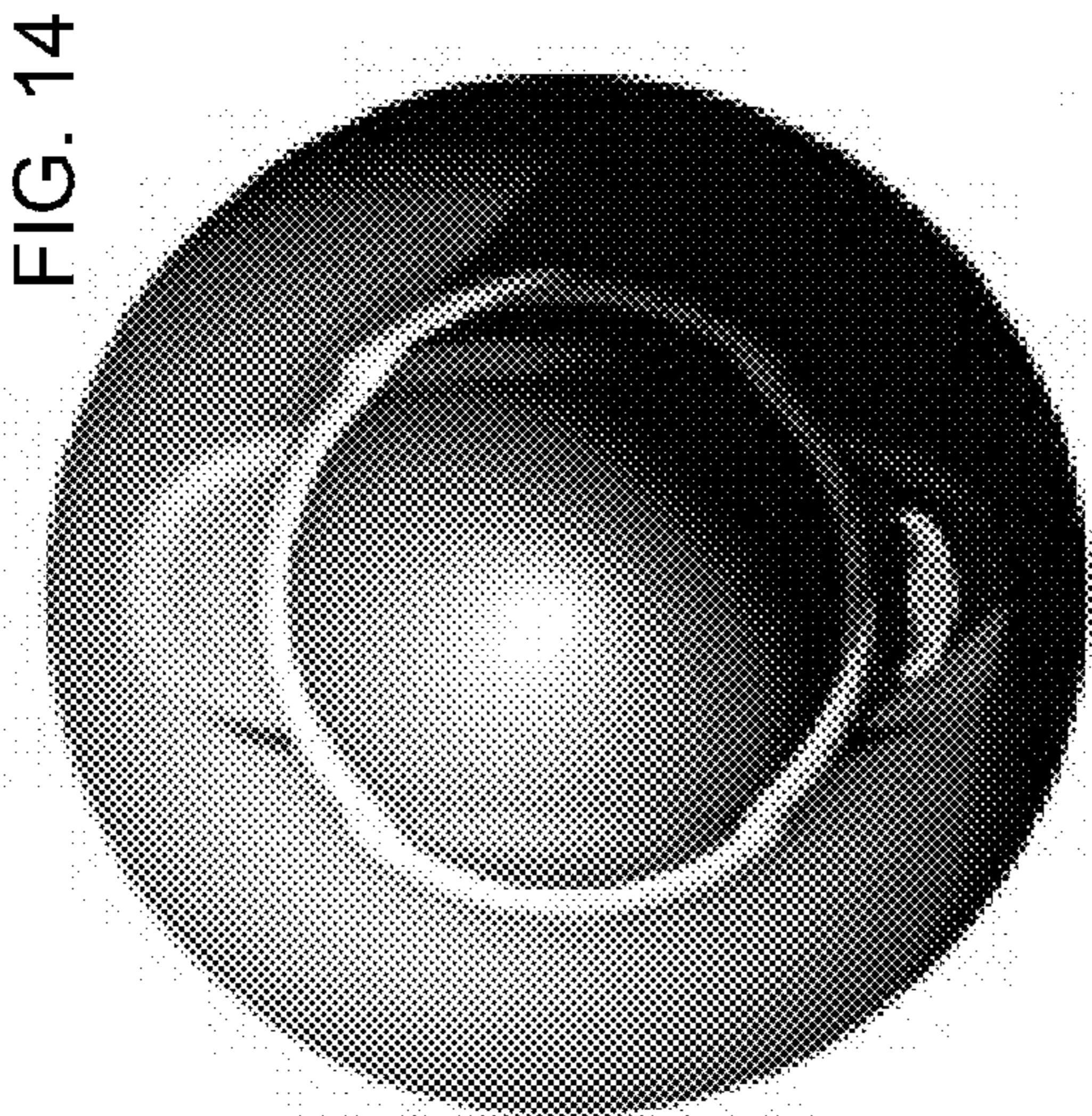

FIG. 15

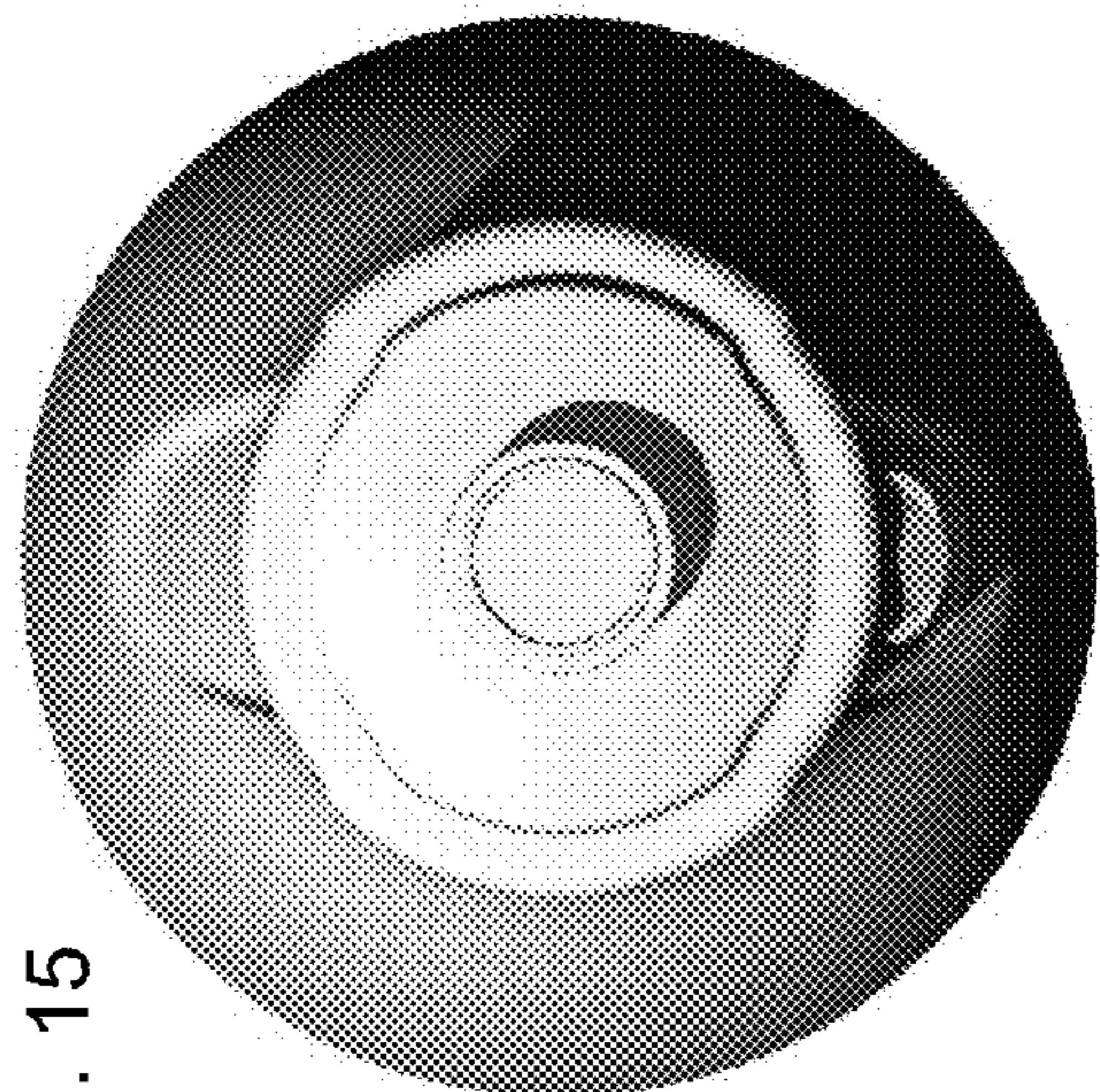
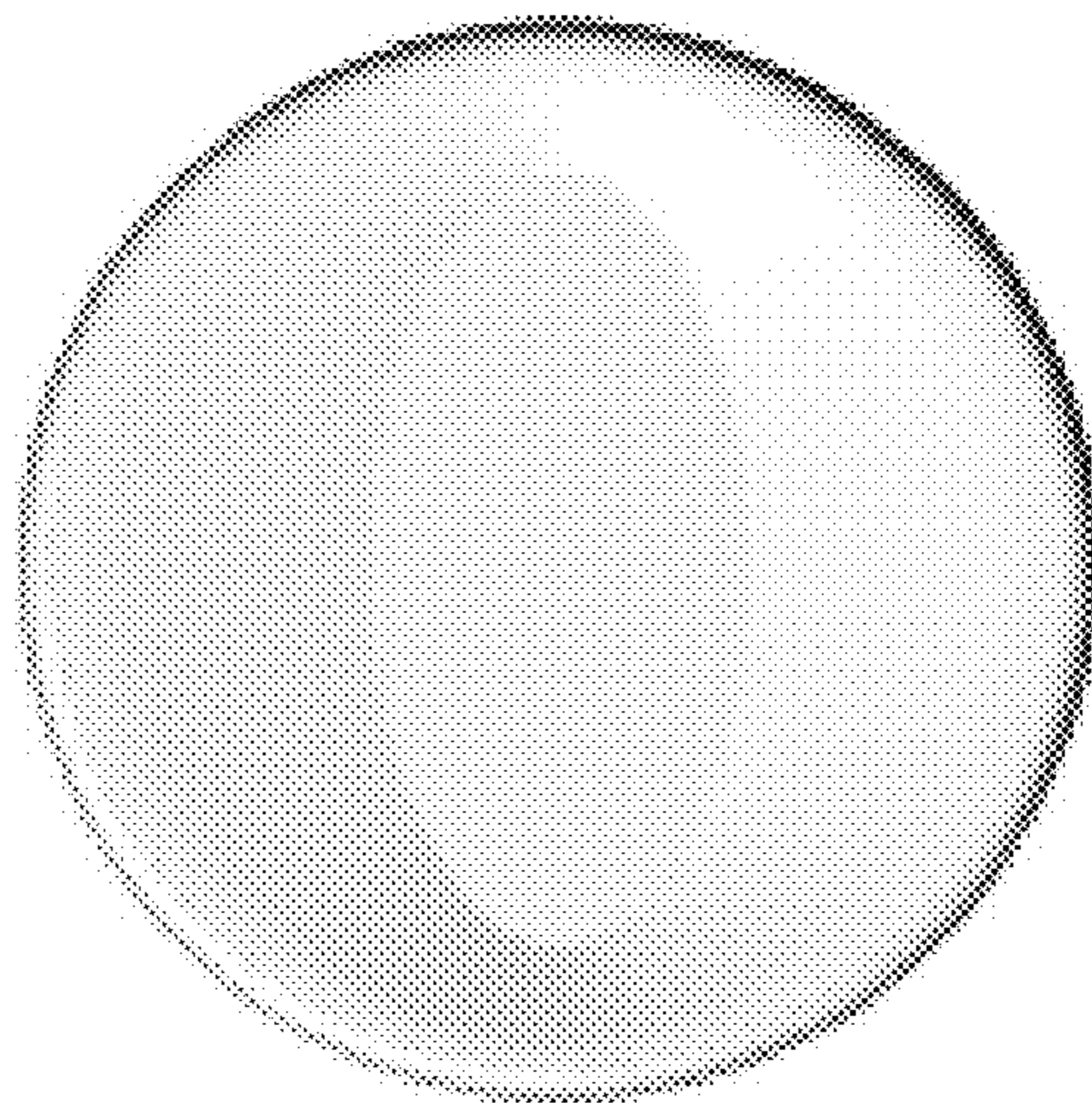

FIG. 16



UNITED STATES PATENT AND TRADEMARK OFFICE
CERTIFICATE OF CORRECTION

PATENT NO. : Des. 606,880 S
APPLICATION NO. : 29/321445
DATED : December 29, 2009
INVENTOR(S) : Sandy Kertesz

Page 1 of 9

It is certified that error appears in the above-identified patent and that said Letters Patent is hereby corrected as shown below:

The title page, showing an illustrative figure, should be deleted and substitute therefor the attached title page.

Delete drawing sheets 1-7 and substitute therefor the drawing sheets, consisting of figures 1-16 as shown on the attached pages.

Signed and Sealed this

Twenty-seventh Day of July, 2010

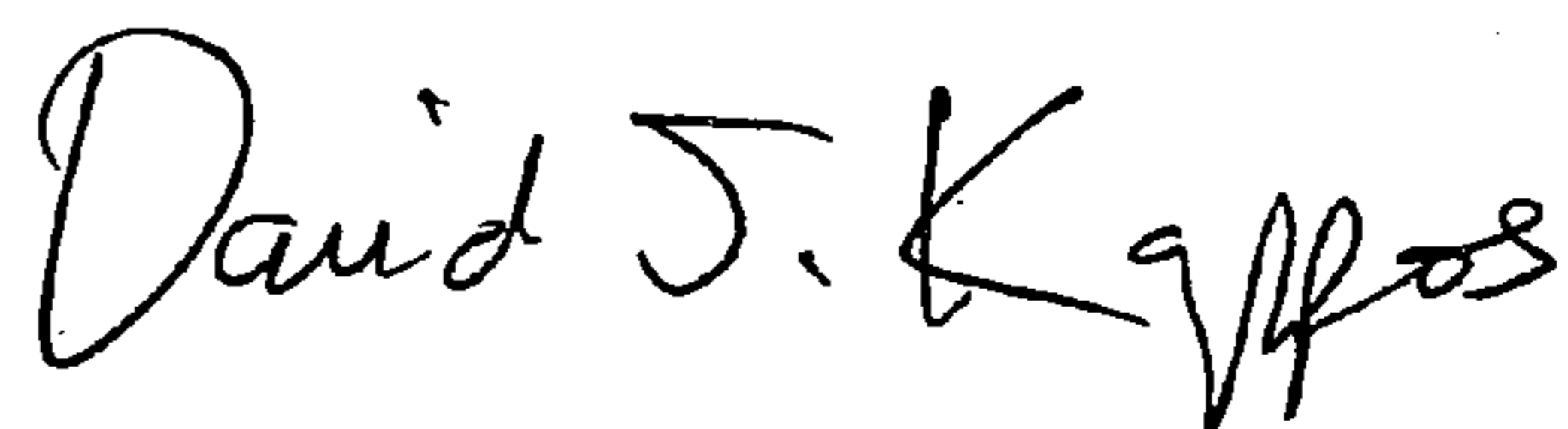

David J. Kappos
Director of the United States Patent and Trademark Office

(12) **United States Design Patent**
Kertesz

(10) **Patent No.:** **US D606,880 S**
(45) **Date of Patent:** **** Dec. 29, 2009**

(54) **BOTTLE**

(75) Inventor: **Sandy Kertesz**, Miami, FL (US)

(73) Assignee: **Emeshel LLC**, Miami, FL (US)

(**) Term: **14 Years**

(21) Appl. No.: **29/321,445**

(22) Filed: **Jul. 16, 2008**

(51) **LOC (9) Cl.** **09-01**

(52) **U.S. Cl.** **D9/674; D9/651**

(58) **Field of Classification Search** **D9/600,**
D9/651, 674, 500-504, 516, 552, 565, 572-575;
206/457-458, 527; 215/379-383, 400; 220/890
See application file for complete search history.

(56) **References Cited**

U.S. PATENT DOCUMENTS

- D188,566 S * 8/1960 Morian D9/674
- D381,897 S * 8/1997 Matthiesen D9/529
- D407,633 S * 4/1999 Jacobs D9/674
- D475,634 S * 6/2003 Cooper D9/572
- D537,730 S * 3/2007 Shimizu et al. D9/674

* cited by examiner

Primary Examiner—Sandra Morris

(74) *Attorney, Agent, or Firm*—Laurence A. Greenberg;
Werner H. Stemer; Ralph E. Locher

(57) **CLAIM**

The ornamental design for a bottle, as shown and described.

DESCRIPTION

FIG. 1 is a front elevational view of the bottle, showing my new design;

FIG. 2 is a right side elevational view thereof;

FIG. 3 is a rear elevational view thereof;

FIG. 4 is a front top perspective view thereof;

FIG. 5 is a rear top perspective view thereof;

FIG. 6 is a front perspective, exploded view thereof;

FIG. 7 is a bottom perspective, exploded view thereof;

FIG. 8 is a front to perspective view of the bottle without the cap;

FIG. 9 is a perspective view of the cap;

FIG. 10 is a front elevational view of the bottle without the cap;

FIG. 11 is a right side elevational view thereof;

FIG. 12 is a rear elevational view thereof;

FIG. 13 is a rear top perspective view thereof;

FIG. 14 is a top plan view of the bottle;

FIG. 15 is a top plan view of the bottle without the cap; and,

FIG. 16 is a bottom plan view of the bottle.

1 Claim, 7 Drawing Sheets



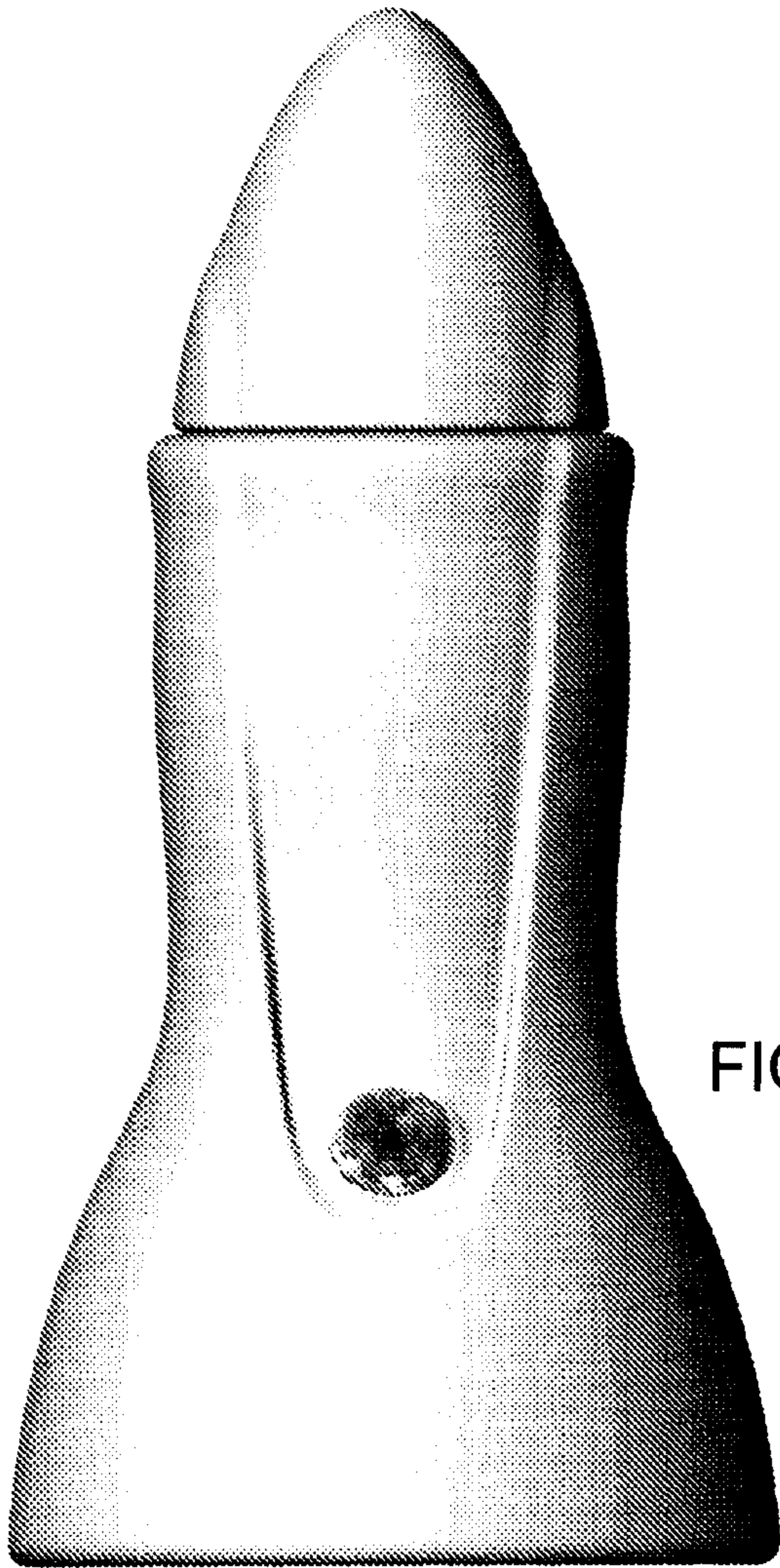

FIG. 1

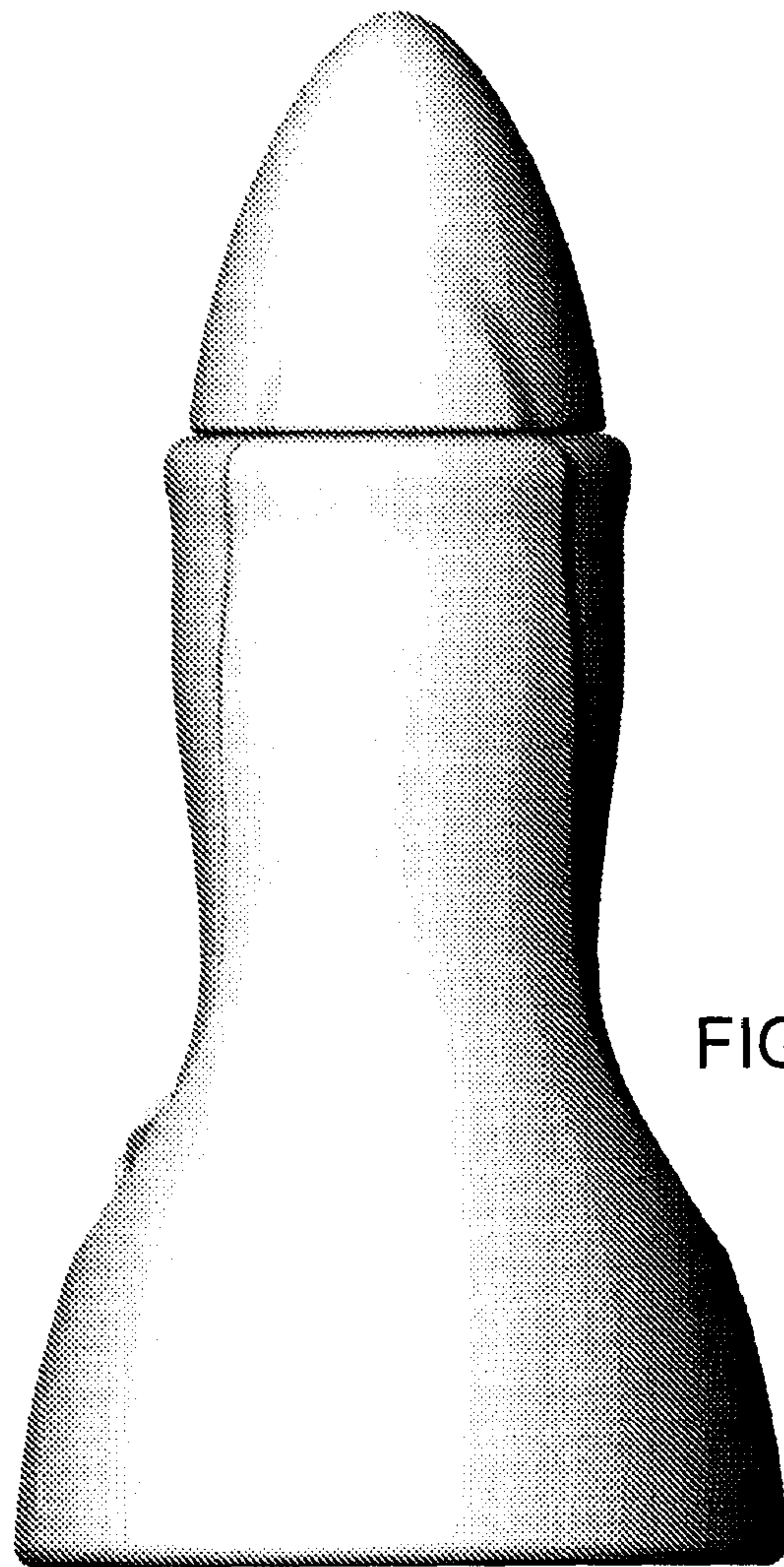

FIG. 2

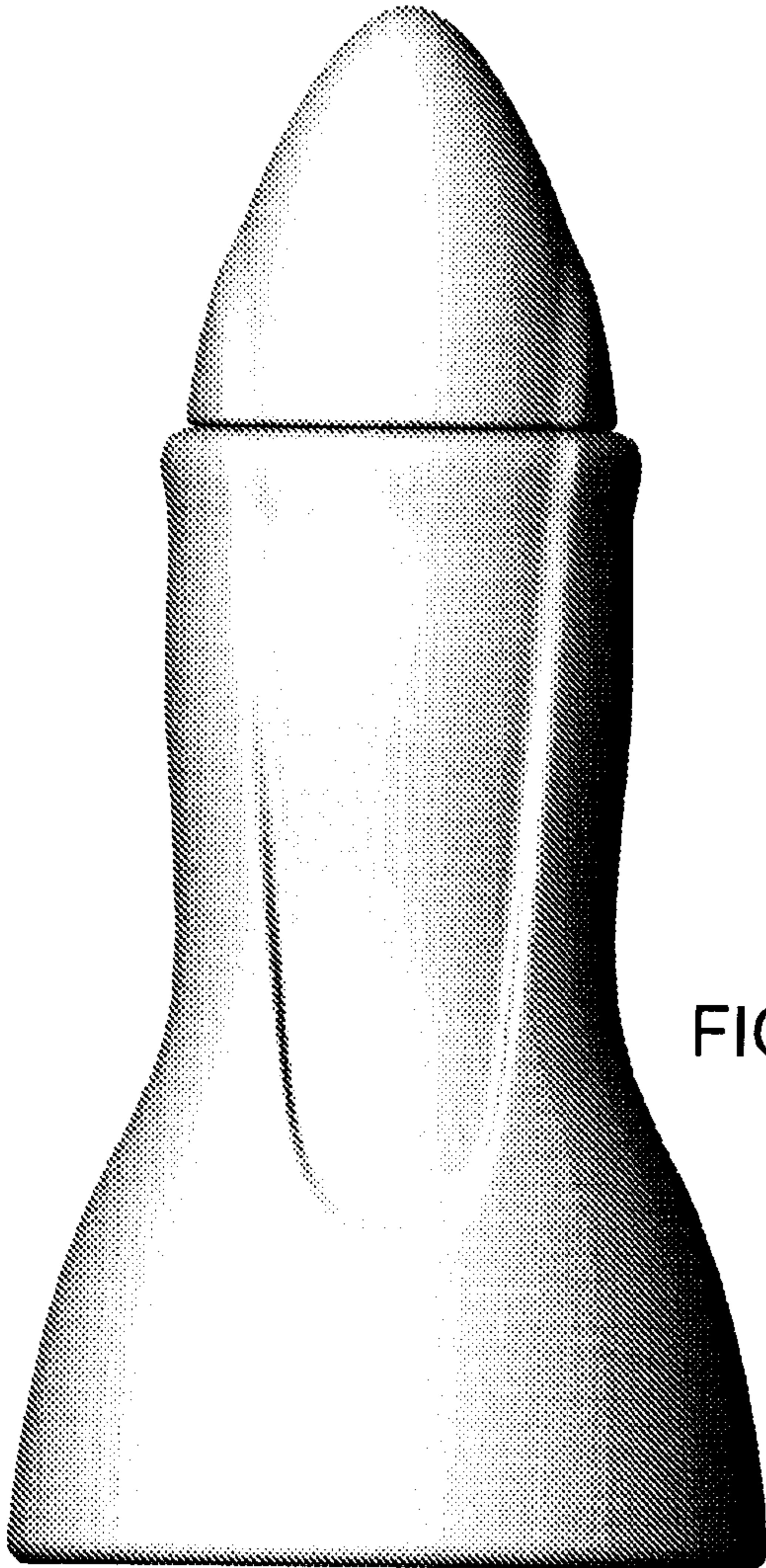

FIG. 3

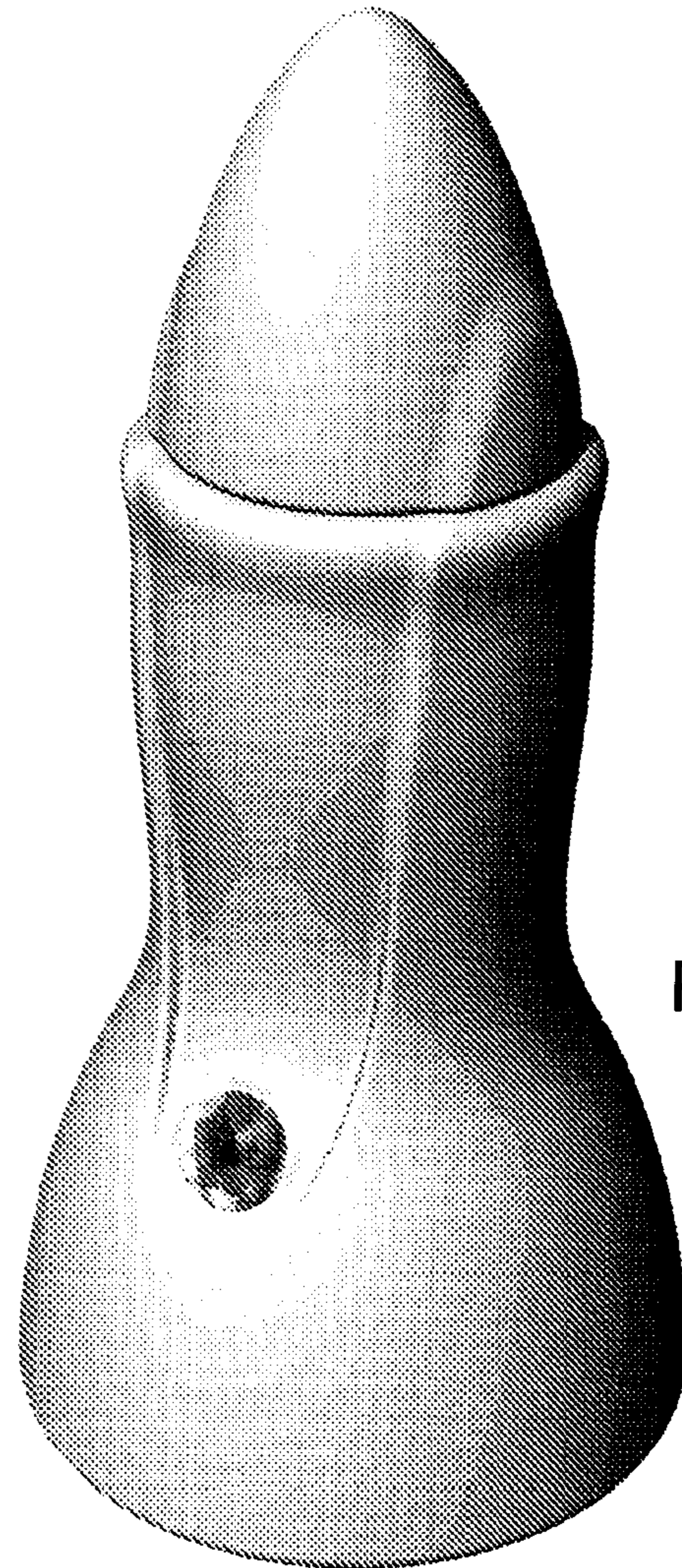

FIG. 4

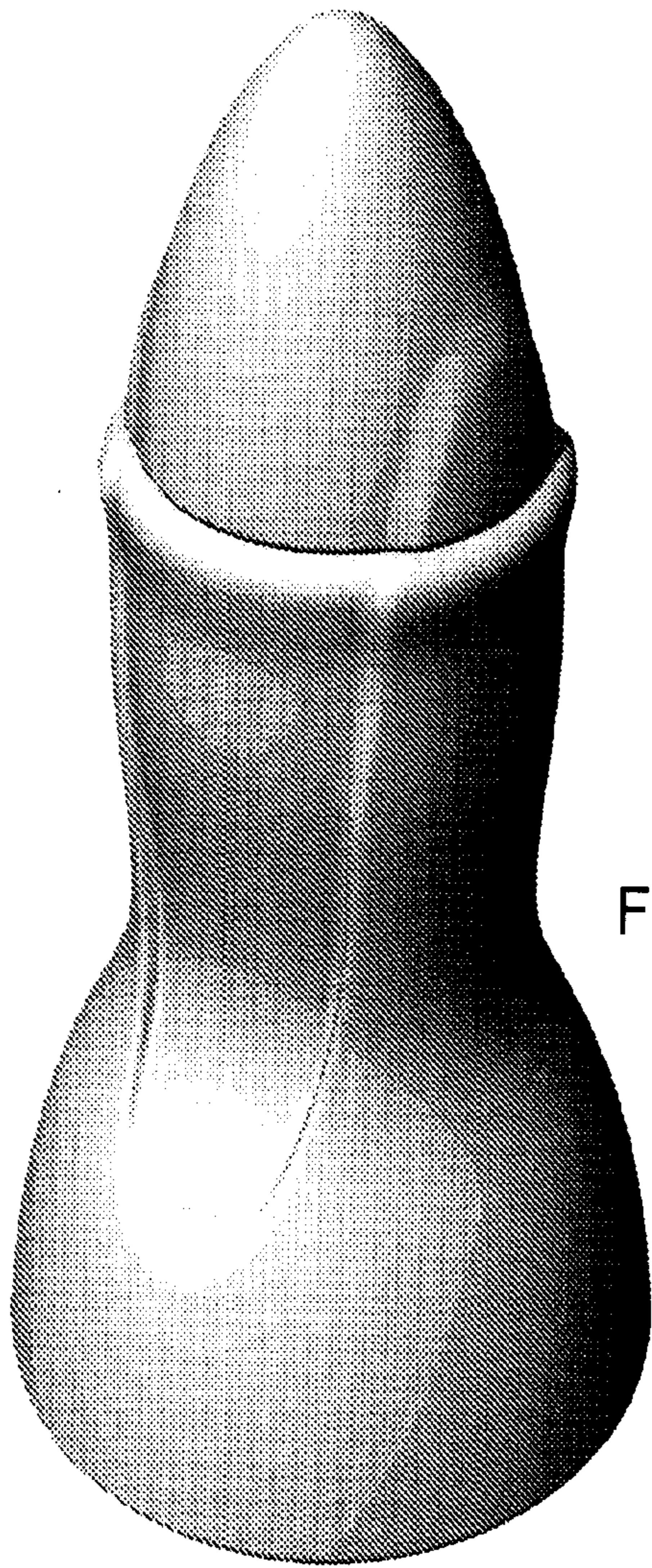

FIG. 5

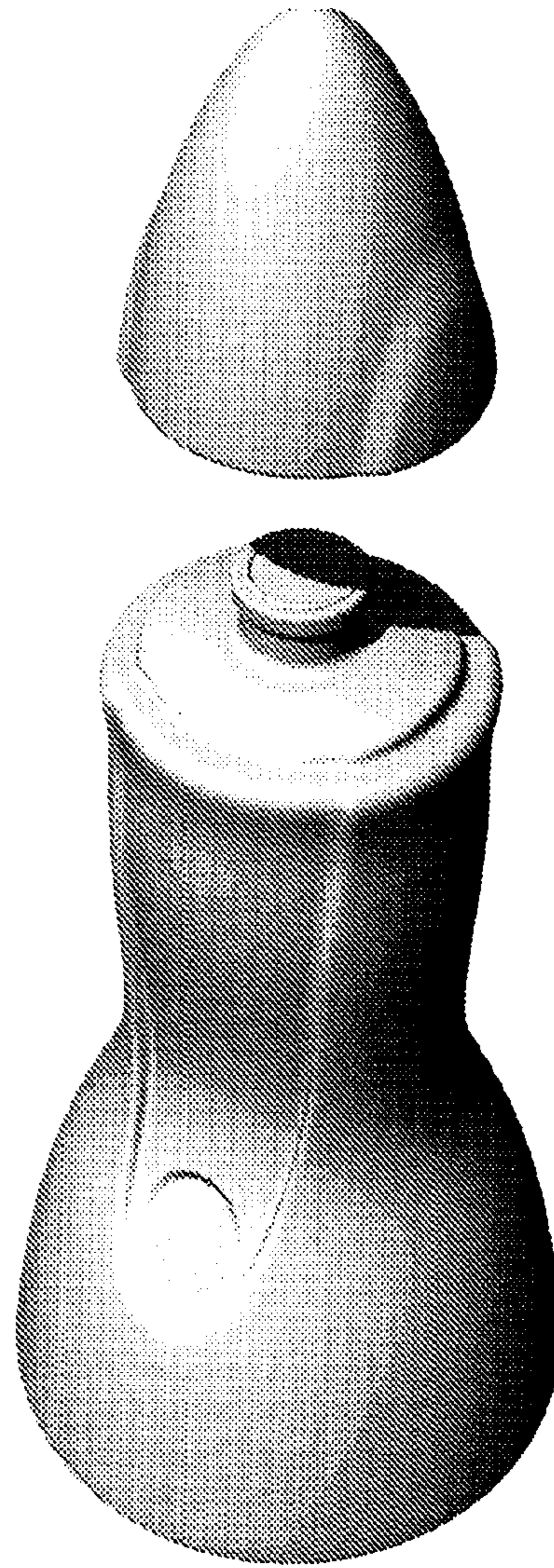

FIG. 6

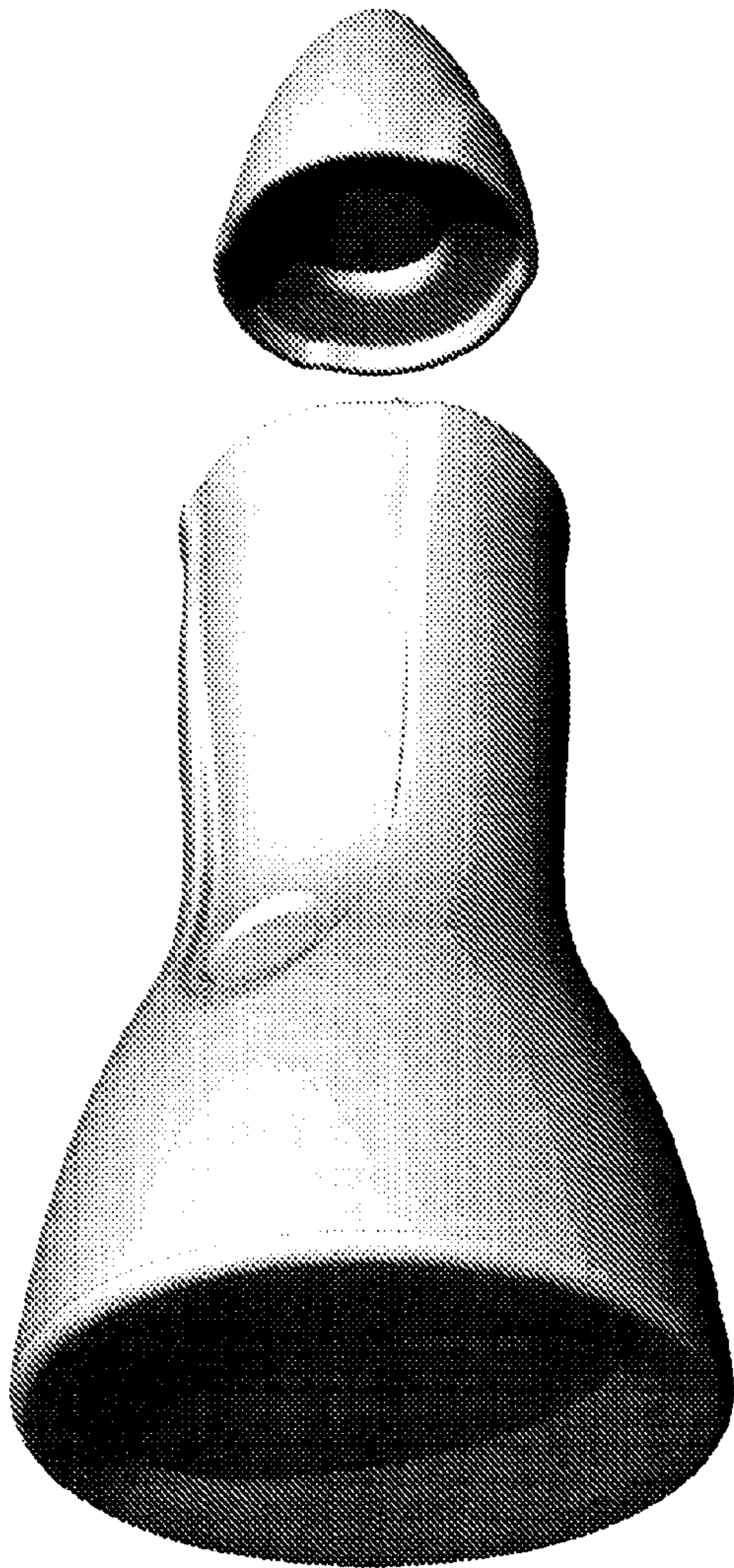

FIG. 7

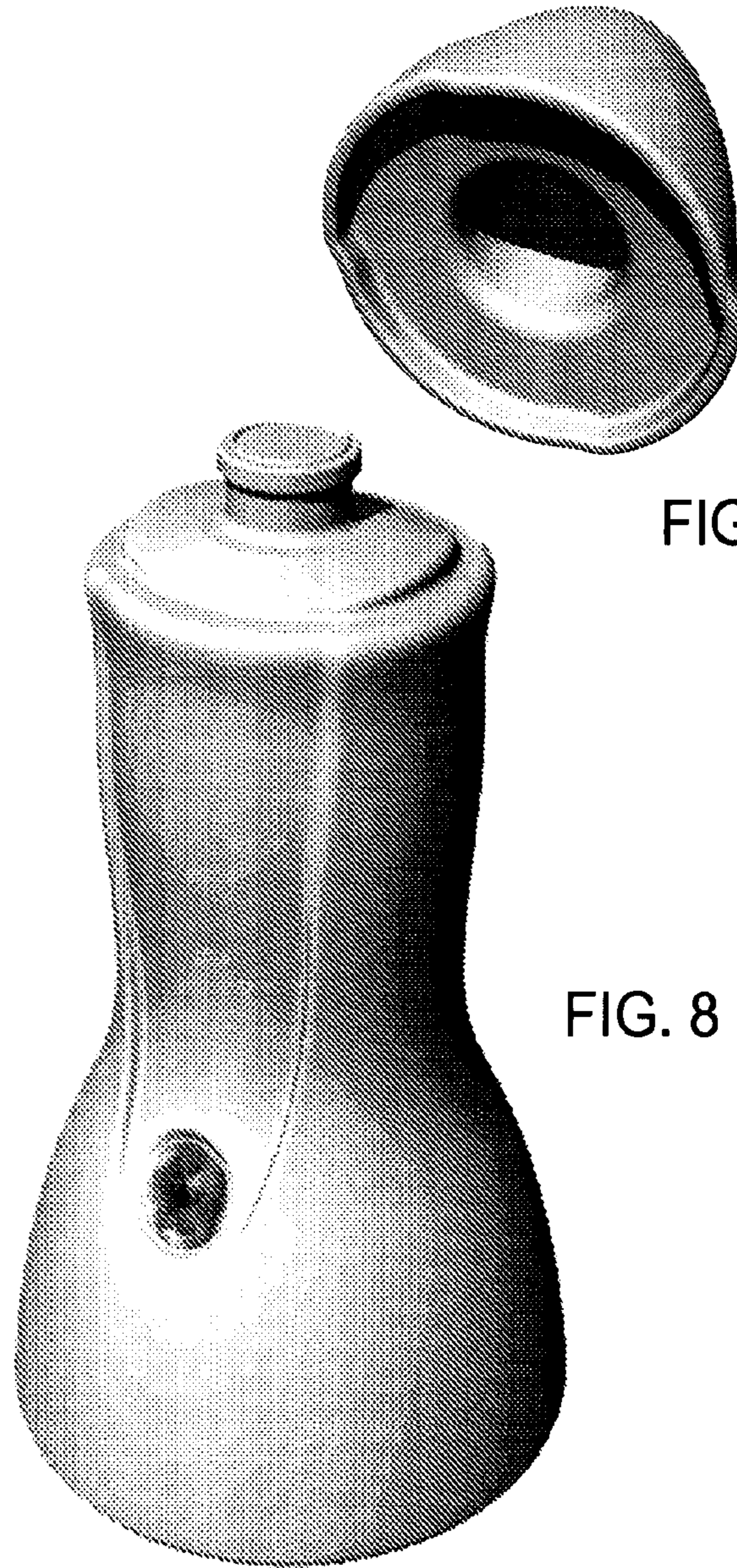

FIG. 9

FIG. 8

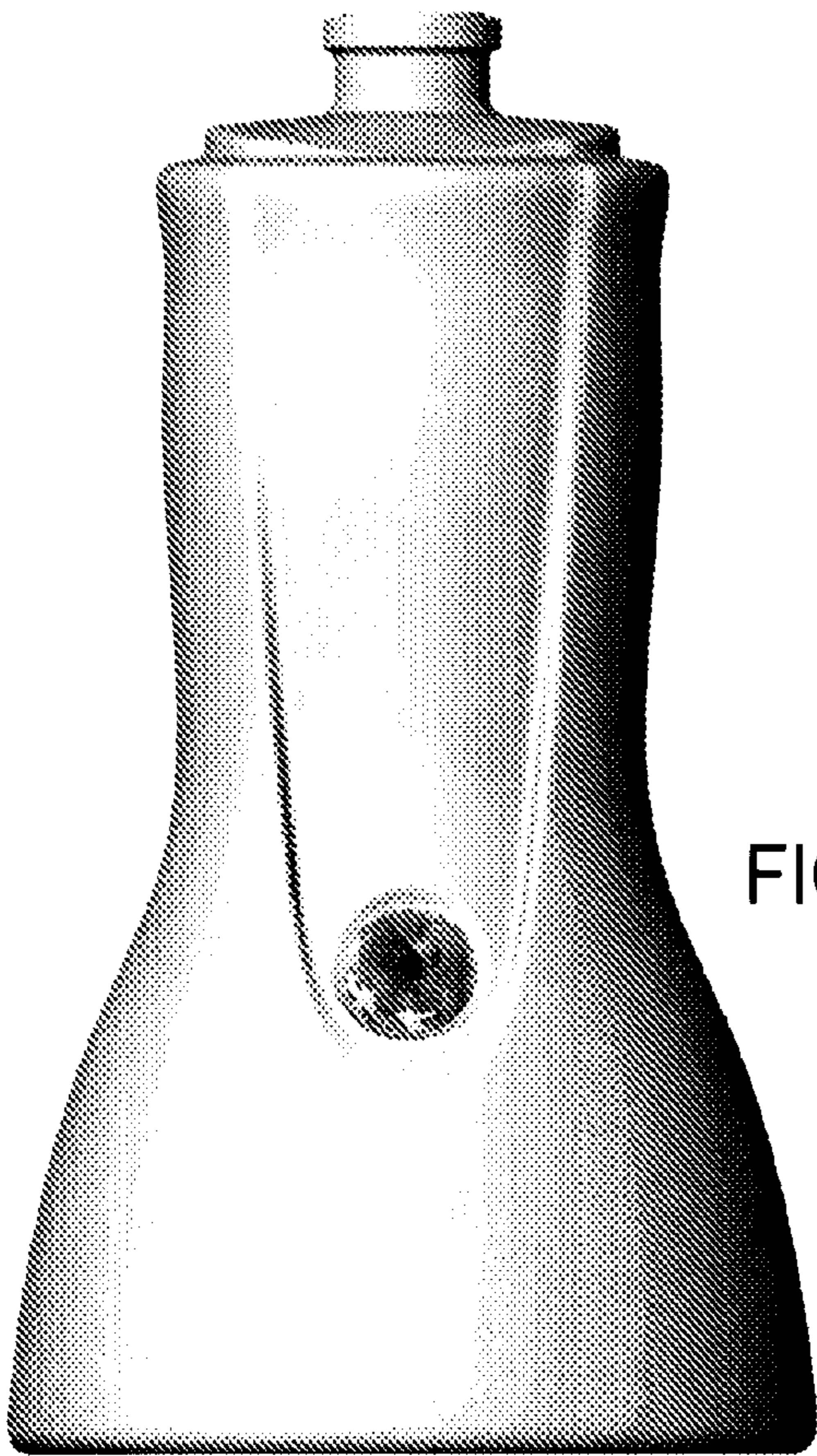

FIG. 10

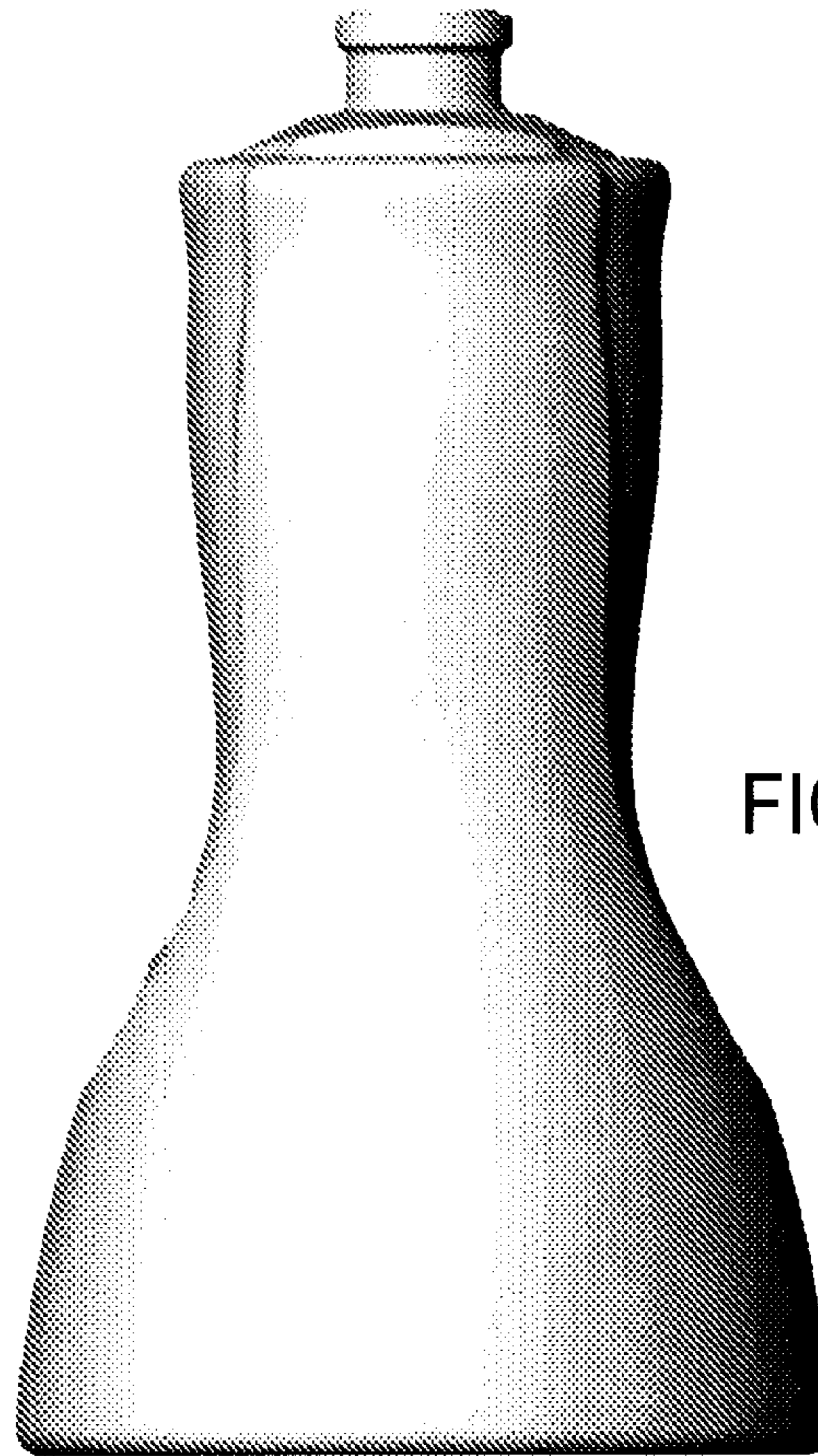

FIG. 11

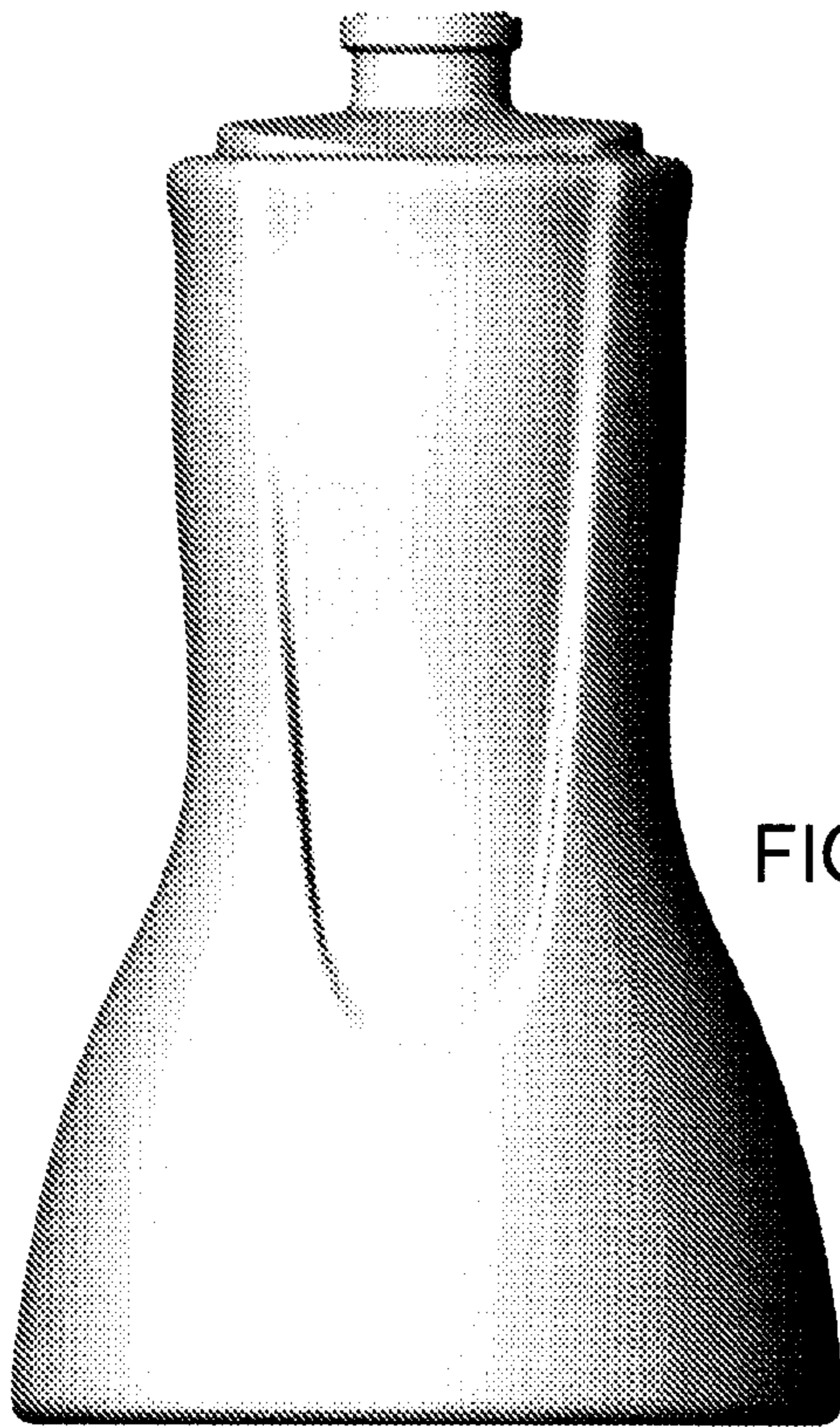

FIG. 12

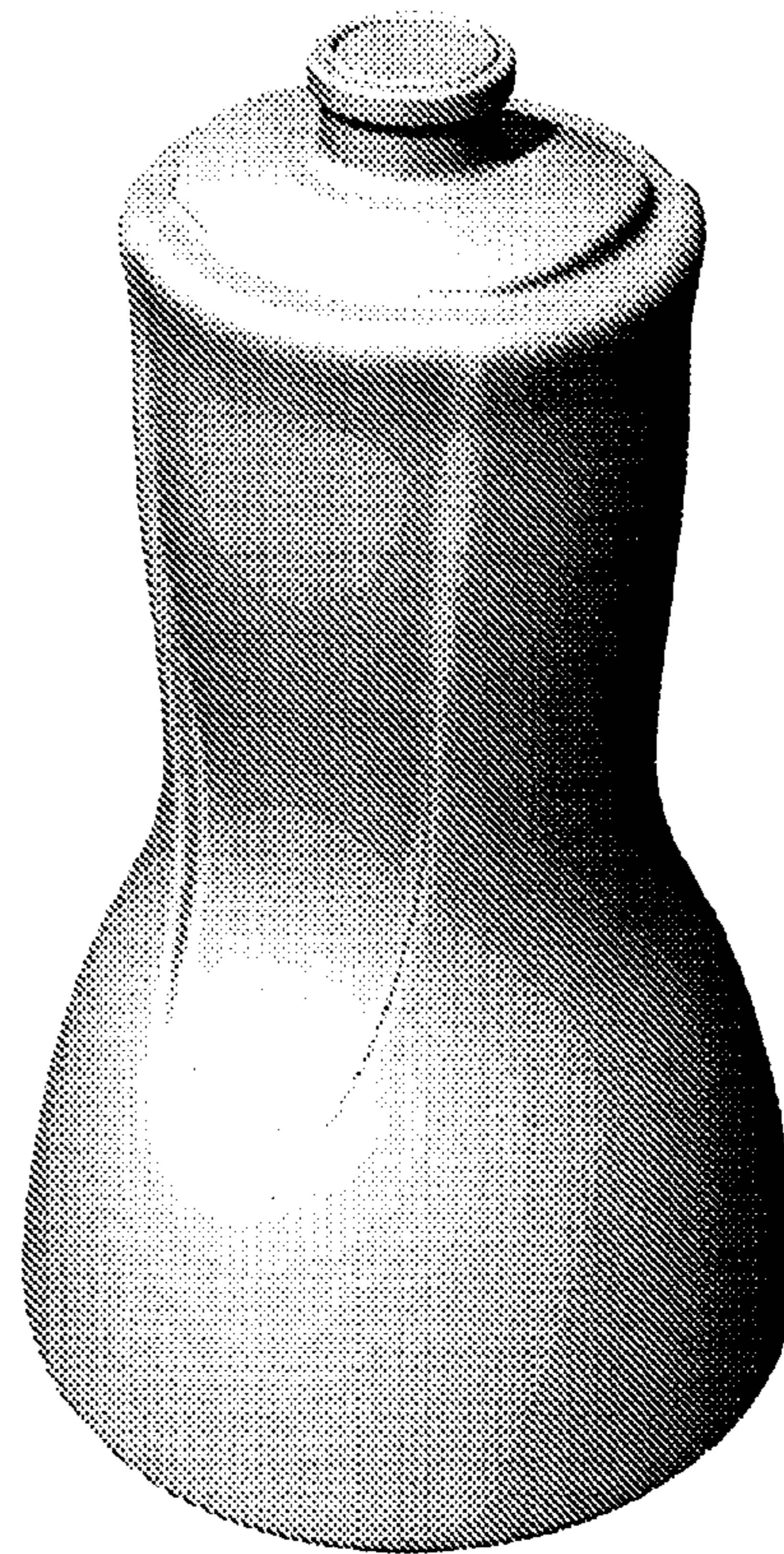

FIG. 13

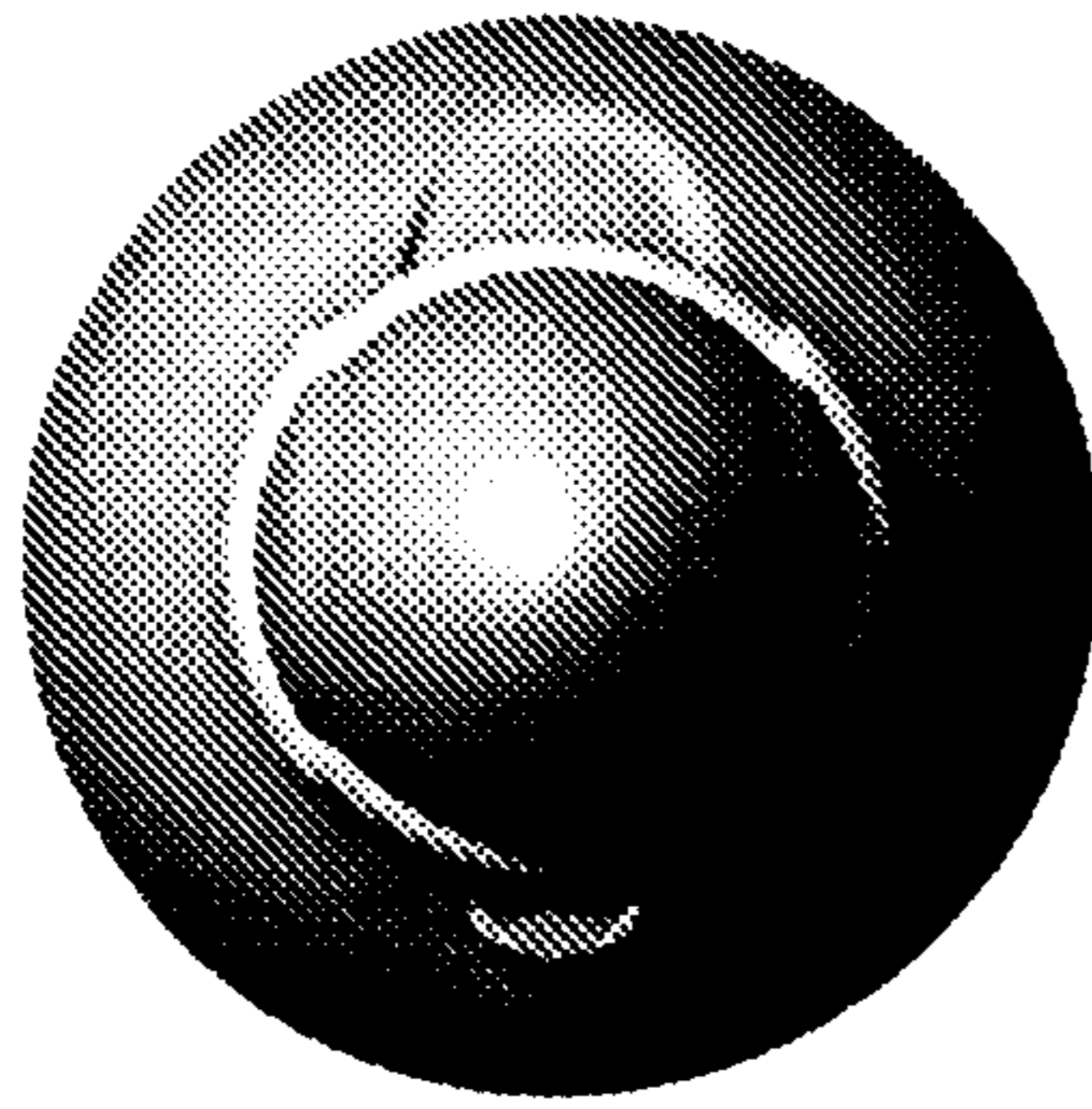

FIG. 14

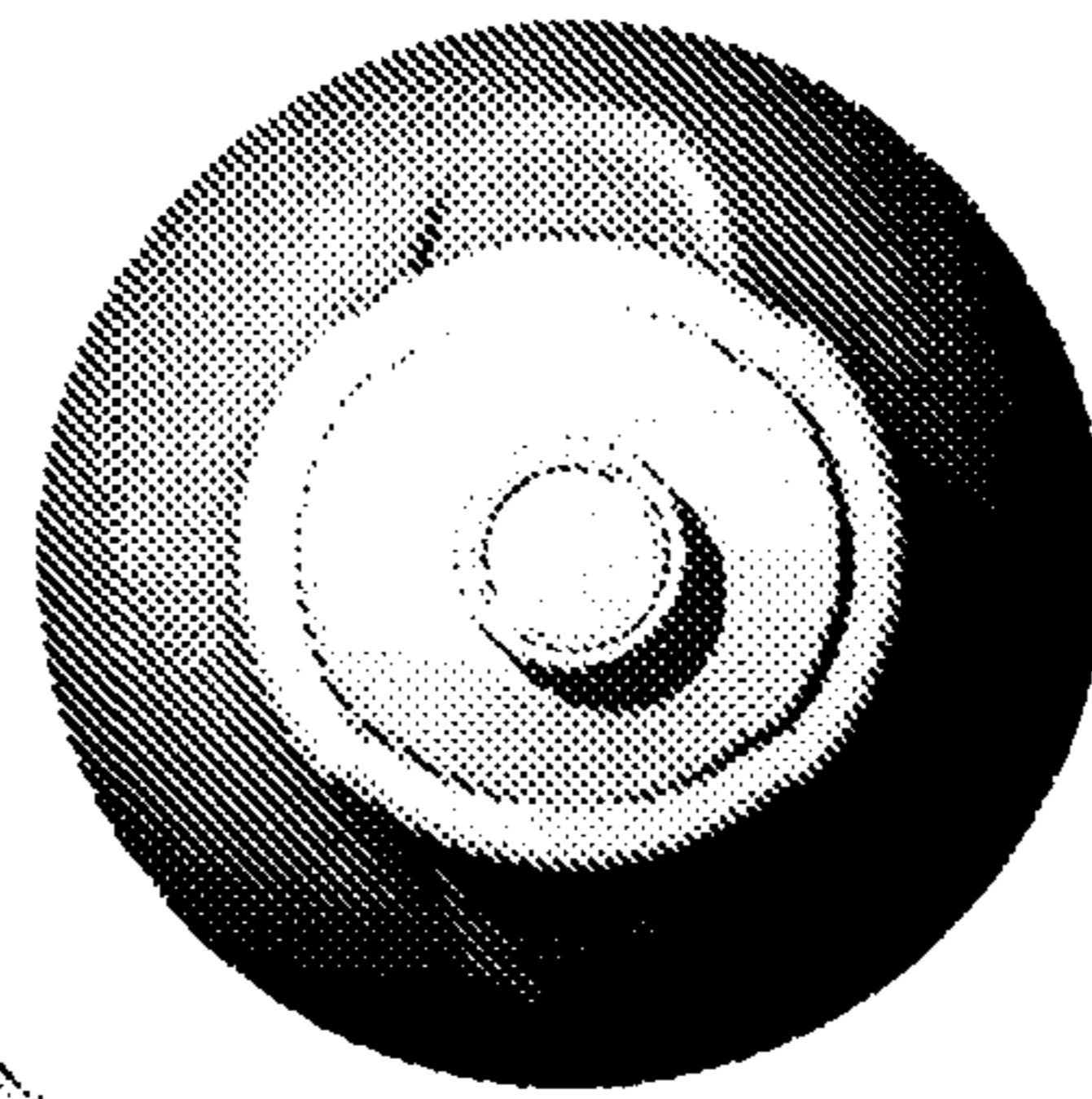

FIG. 15

FIG. 16

