



US00D606878S

(12) **United States Design Patent**
Lindfors

(10) **Patent No.:** **US D606,878 S**
(45) **Date of Patent:** **** Dec. 29, 2009**

(54) **BOTTLE**

(75) Inventor: **Stefan Lindfors**, Helsinki (FI)

(73) Assignee: **Plup Oy AB Ltd.**, Helsinki (FI)

(**) Term: **14 Years**

(21) Appl. No.: **29/313,027**

(22) Filed: **Dec. 2, 2008**

(30) **Foreign Application Priority Data**

Jun. 5, 2008 (EM) 000947072

(51) **LOC (9) Cl.** **09-01**

(52) **U.S. Cl.** **D9/666; D9/519; D9/526;**
D9/535

(58) **Field of Classification Search** D9/600,
D9/666, 516, 519, 526, 535; 206/457-458,
206/527; 215/400; 220/890; D7/514-515
See application file for complete search history.

(56) **References Cited**

U.S. PATENT DOCUMENTS

D98,455 S * 2/1936 Mascolo D9/666
D195,281 S * 5/1963 Gerlain D9/666

D301,307 S * 5/1989 Pakzad D9/535
D343,660 S * 1/1994 Hwang D9/535
D395,240 S * 6/1998 Dinand D9/526
6,672,249 B2 * 1/2004 Garcia-Lucio et al. 119/72
D514,939 S * 2/2006 Miozzo et al. D9/526
D550,086 S * 9/2007 Burks D9/519

* cited by examiner

Primary Examiner—Sandra Morris

(74) *Attorney, Agent, or Firm*—Klauber & Jackson LLC

(57) **CLAIM**

The ornamental design for a bottle, as shown and described.

DESCRIPTION

FIG. 1 is a right front elevational perspective view showing the front, right side and top of a bottle of my new design;

FIG. 2 is a front view thereof;

FIG. 3 is a rear view thereof;

FIG. 4 is a right side view thereof;

FIG. 5 is a left side view thereof;

FIG. 6 is a top view thereof; and,

FIG. 7 is a bottom view thereof.

1 Claim, 5 Drawing Sheets

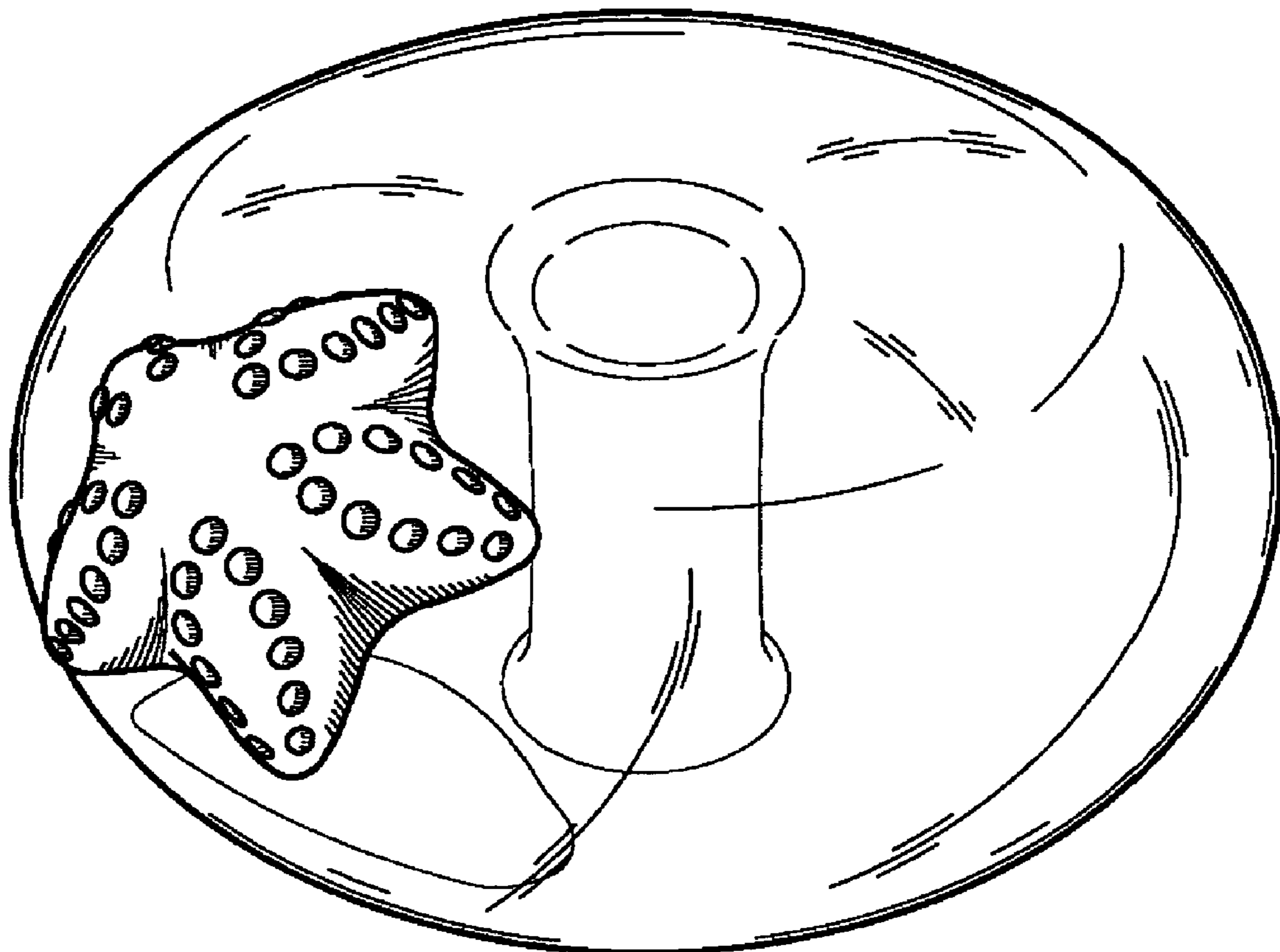

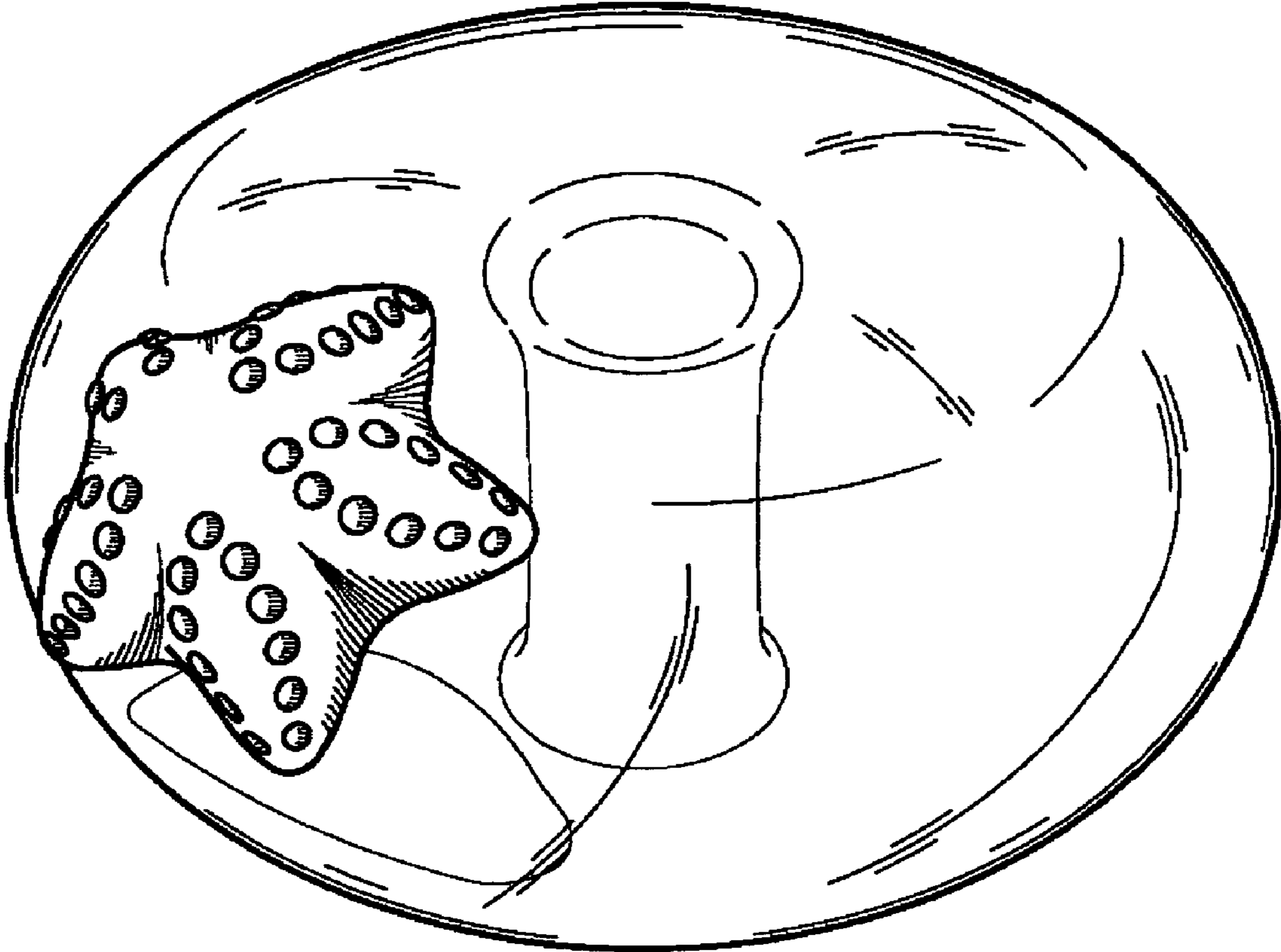

FIG. 1

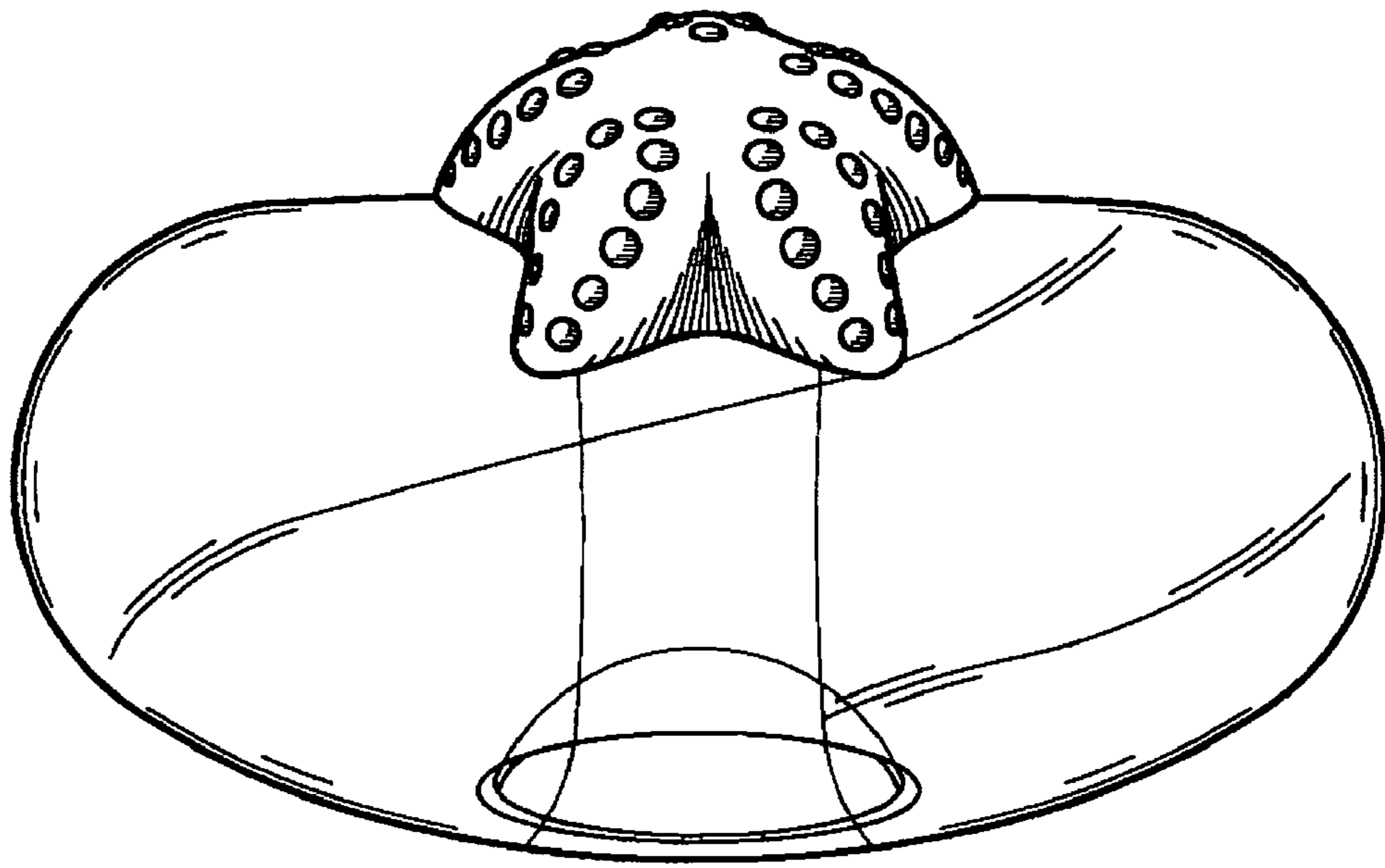

FIG. 2

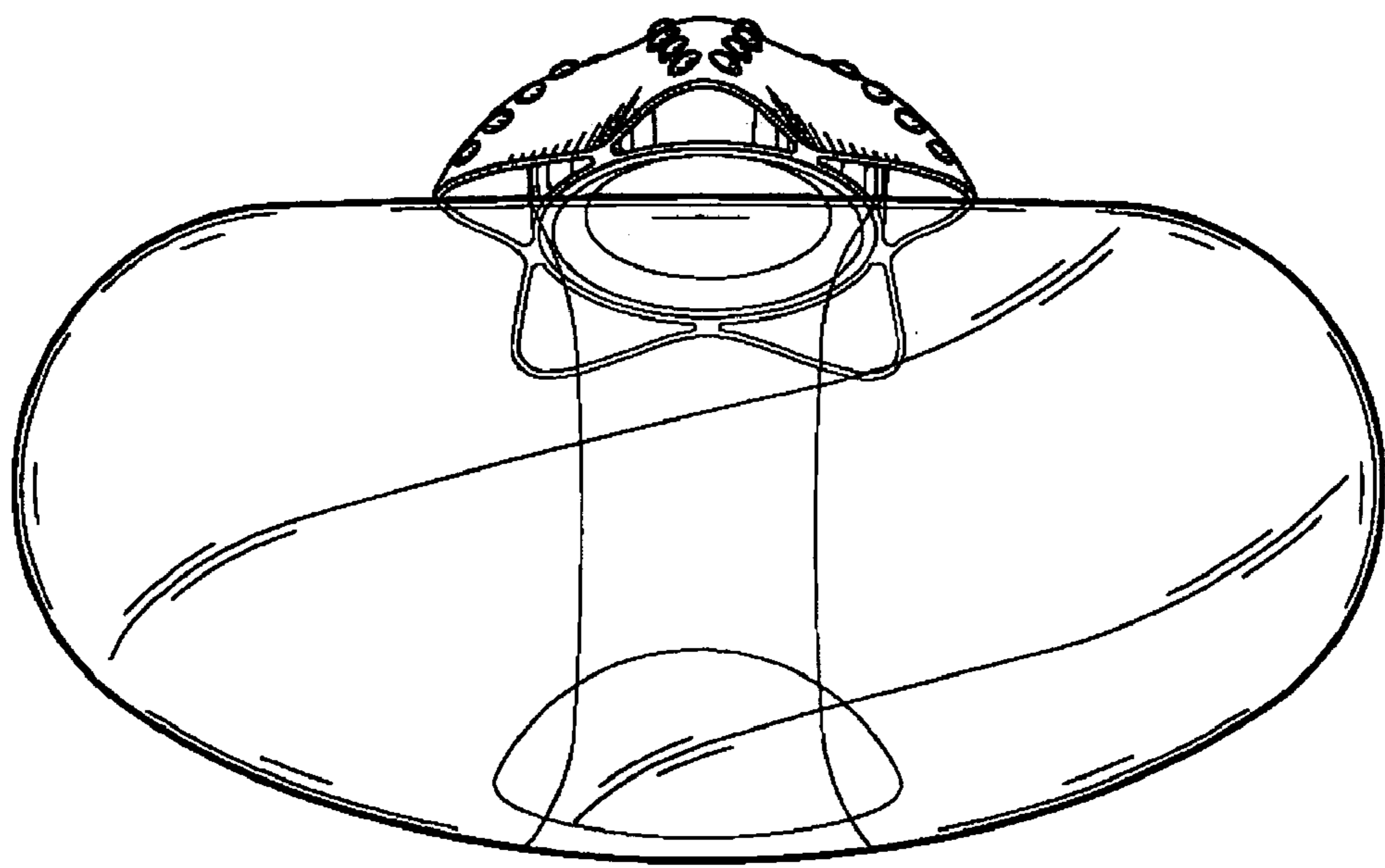

FIG. 3

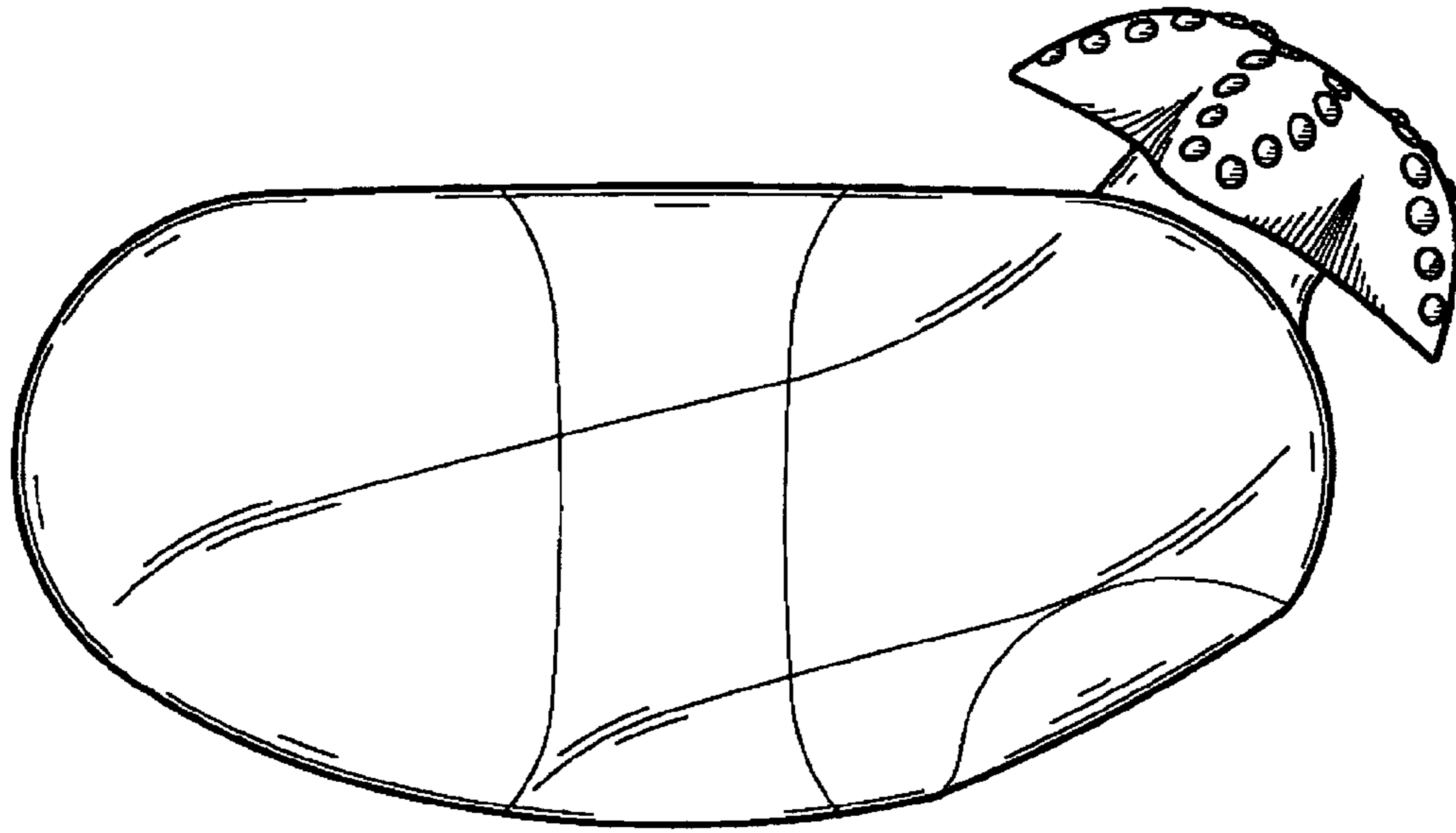

FIG. 4

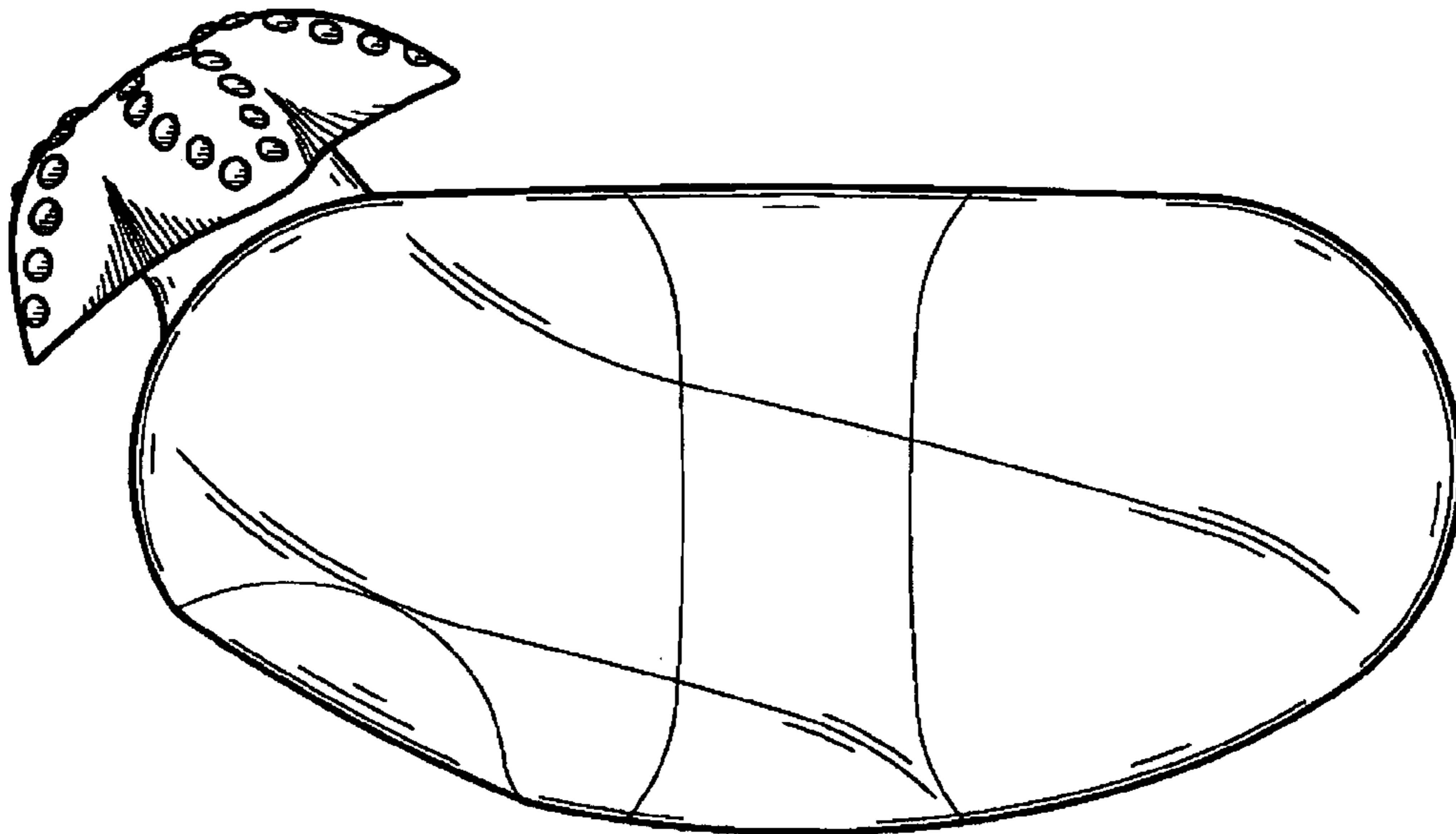

FIG. 5

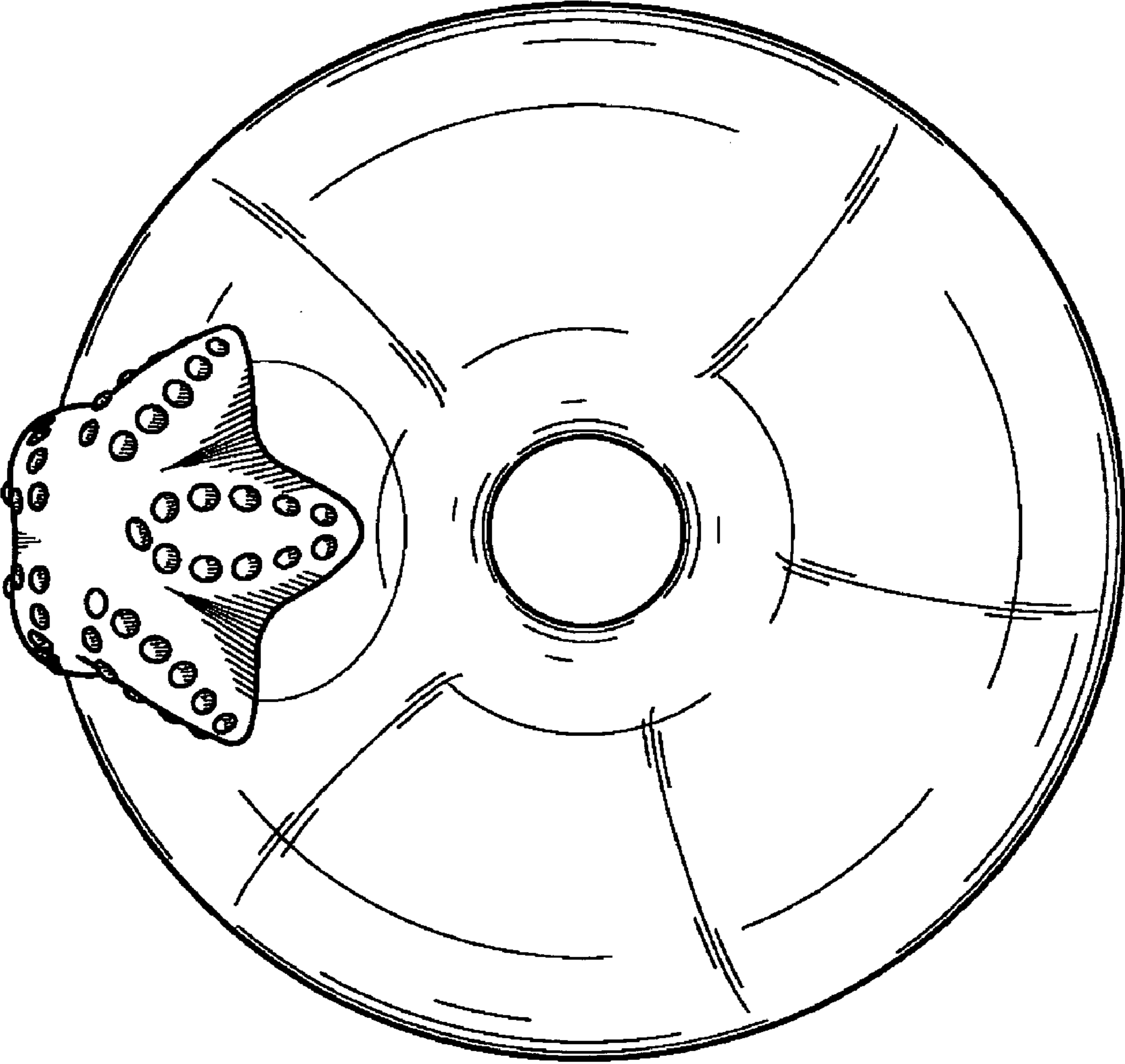

FIG. 6

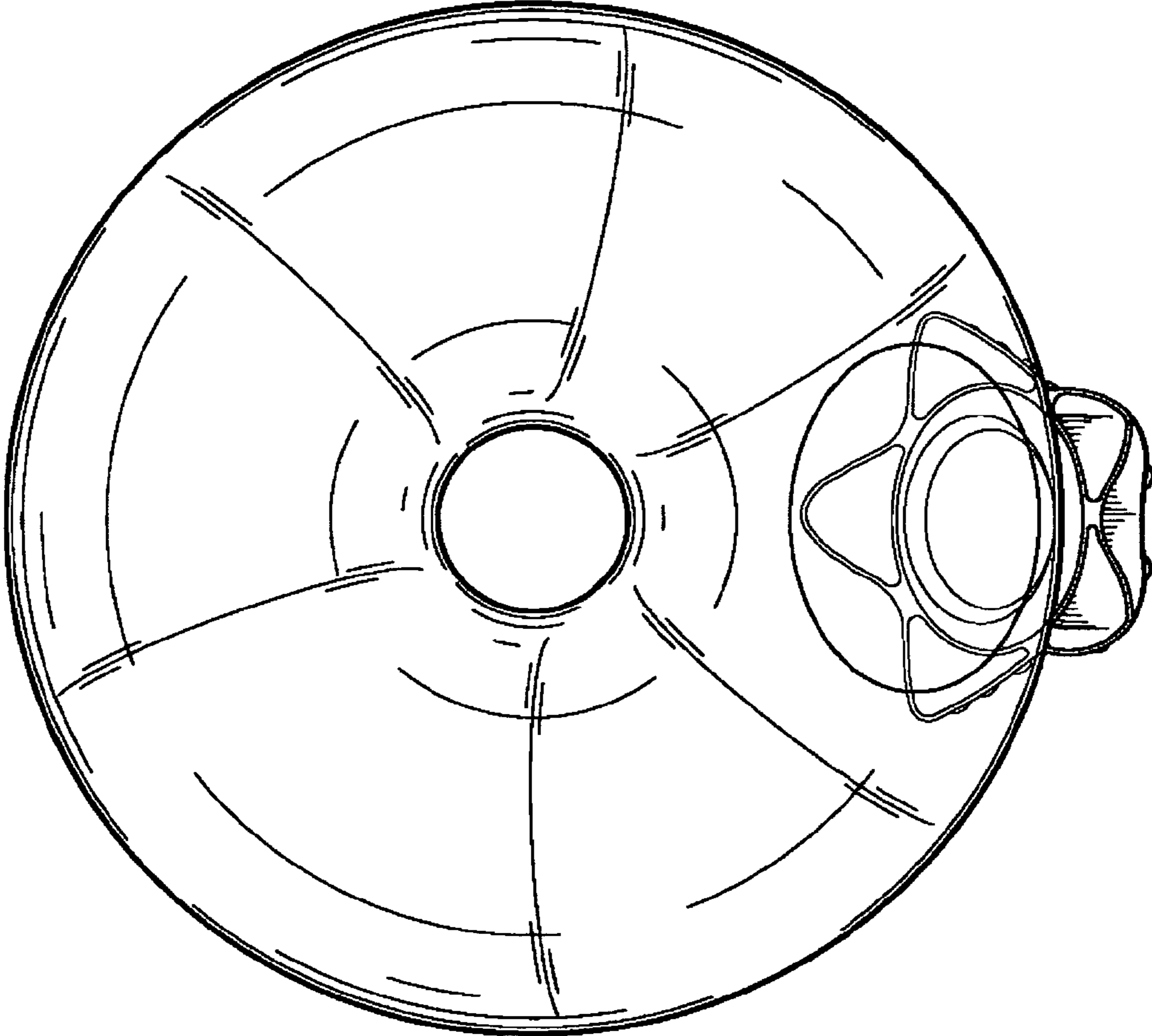

FIG. 7