



US00D606859S

(12) **United States Design Patent**
Stewart

(10) **Patent No.:** **US D606,859 S**

(45) **Date of Patent:** **** Dec. 29, 2009**

(54) **RECYCLABLE JEWELRY BOX**

(75) Inventor: **Glenn Stewart**, Dallas, TX (US)

(73) Assignee: **Spirit Merchandise Group, Inc.**,
Carrollton, TX (US)

(**) Term: **14 Years**

(21) Appl. No.: **29/324,629**

(22) Filed: **Sep. 16, 2008**

D330,853	S	*	11/1992	Koytuk	D9/421
5,183,200	A	*	2/1993	Okamoto	229/122.27
5,586,717	A	*	12/1996	Hallam	229/116.1
D385,781	S	*	11/1997	Levine et al.	D9/737
D407,308	S	*	3/1999	Driscoll	D9/432
D415,419	S	*	10/1999	Abiteboul	D9/423
6,012,631	A	*	1/2000	Hallam	229/163
6,182,830	B1	*	2/2001	Au et al.	206/762
6,352,151	B1	*	3/2002	Stewart	206/45.29
D455,076	S	*	4/2002	Gumper	D9/433
D456,709	S	*	5/2002	Dionisio	D9/418
D509,425	S	*	9/2005	Learey	D9/432
D510,262	S	*	10/2005	Isono et al.	D9/423
D549,451	S	*	8/2007	Sann	D23/294

Related U.S. Application Data

(63) Continuation-in-part of application No. 29/322,799,
filed on Aug. 12, 2008.

(51) **LOC (9) Cl.** **09-03**

(52) **U.S. Cl.** **D9/432**

(58) **Field of Classification Search** D9/430-433,
D9/414, 418, 420-423; D3/272; 206/278,
206/297, 299, 457, 770, 737, 822; 229/100,
229/101, 101.3, 106, 108, 108.1, 116.1, 116.3,
229/116.5, 121, 122, 201, 213, 221, 222,
229/227, 922, 939, 942

See application file for complete search history.

(56) **References Cited**

U.S. PATENT DOCUMENTS

1,944,714	A	*	1/1934	Lehmann	206/752
2,024,702	A	*	12/1935	Powell	206/45.29
2,061,992	A	*	11/1936	Wilson	229/116.1
D103,668	S	*	3/1937	Case	D9/420
2,304,758	A	*	12/1942	Botham	132/315
2,438,982	A	*	4/1948	Williamson	229/5.83
D155,246	S	*	9/1949	Von Miklos	D9/421
3,237,838	A	*	3/1966	Elias	229/122.27
3,335,938	A	*	8/1967	Kramer	229/118
D254,896	S	*	5/1980	Moore	D9/432
D297,214	S	*	8/1988	Forbes, Jr.	D9/416
4,767,000	A	*	8/1988	Ovadia et al.	206/760

* cited by examiner

Primary Examiner—Robert M Spear

Assistant Examiner—Karen Acker

(74) *Attorney, Agent, or Firm*—David W. Carstens; Carstens
& Cahoon, LLP

(57) **CLAIM**

The ornamental design for a recyclable jewelry box, as shown
and described.

DESCRIPTION

FIG. 1 is a perspective view of the recyclable jewelry box of
the present invention with the lid open;

FIG. 2 is a perspective view of the recyclable jewelry box of
the present invention with the lid closed;

FIG. 3 is a bottom view thereof;

FIG. 4 is a bottom view thereof shown in an alternate con-
figuration of use with the lid folded back;

FIG. 5 is a front elevation view of FIG. 2;

FIG. 6 is a back elevation view;

FIG. 7 is a left side elevation view; and,

FIG. 8 is a right side elevation view.

1 Claim, 4 Drawing Sheets

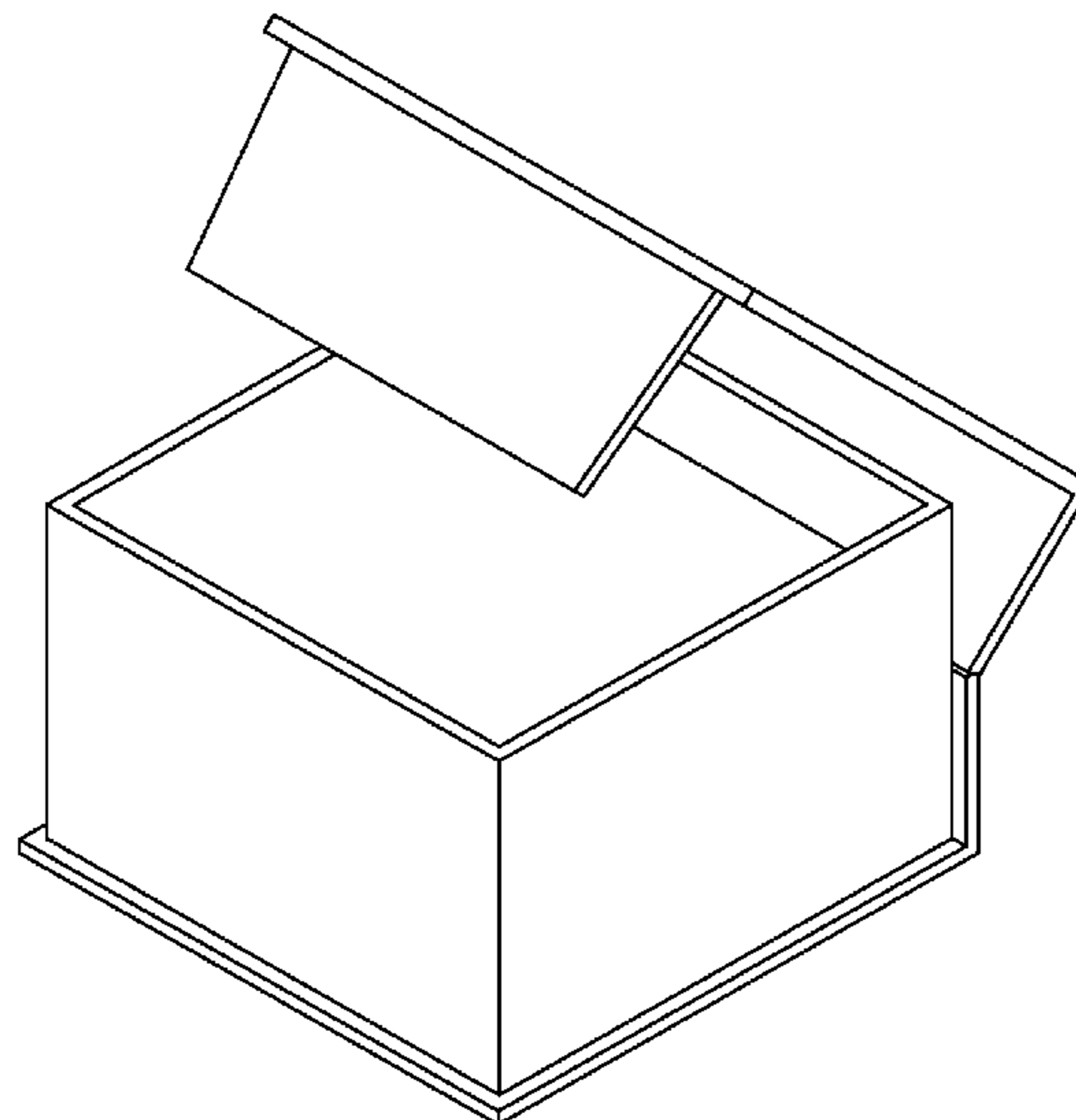

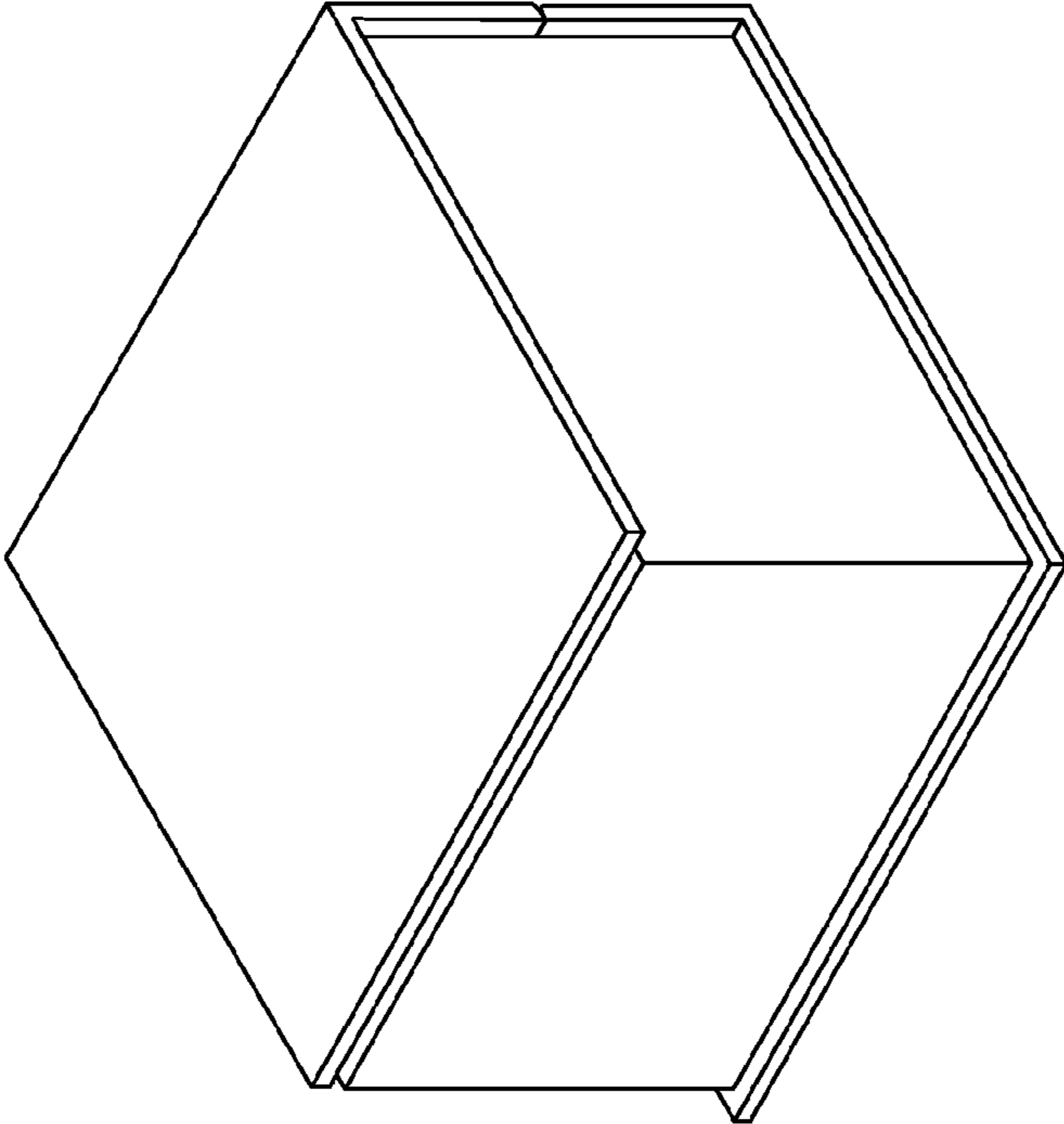

FIG. 2

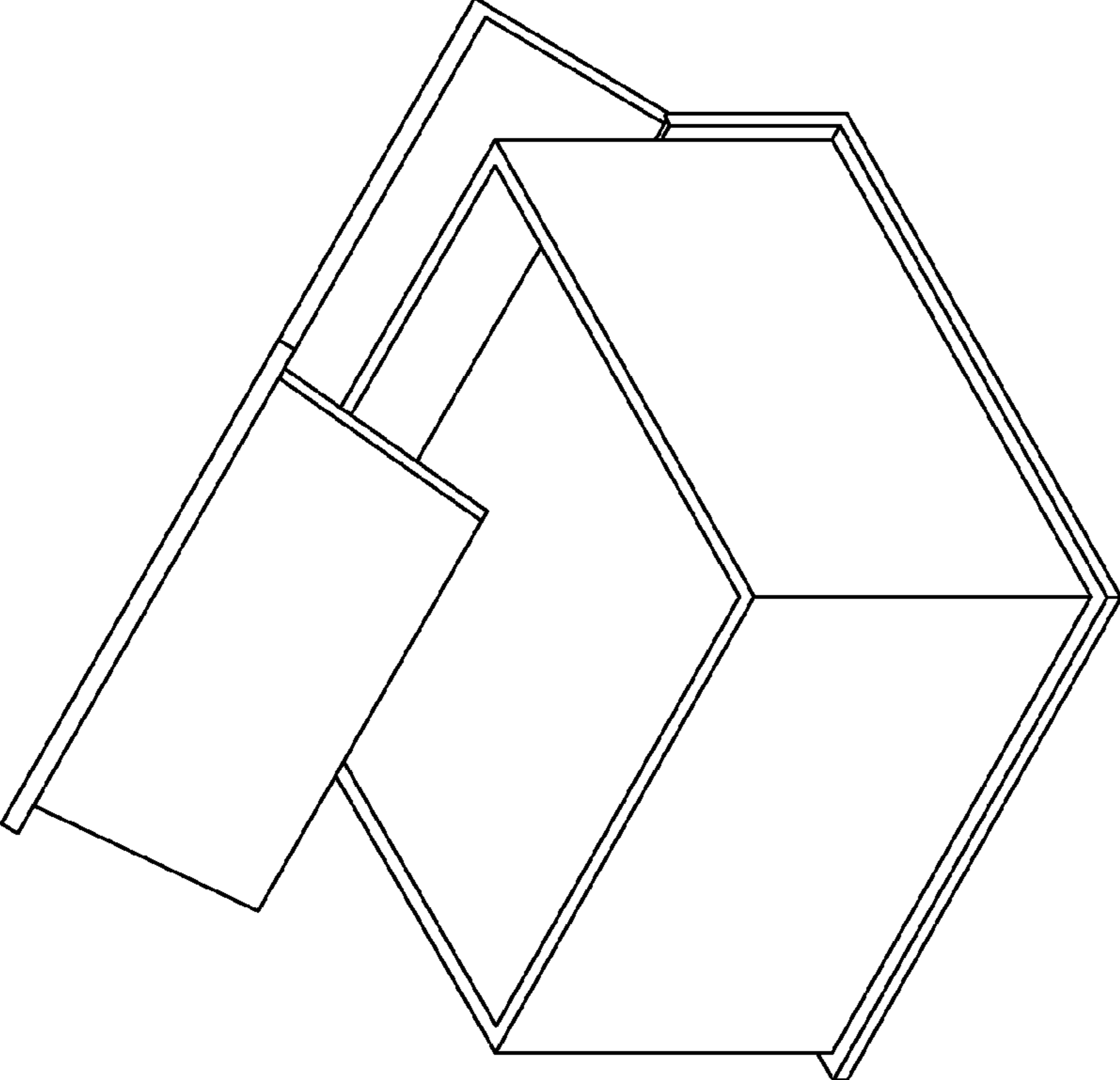

FIG. 1

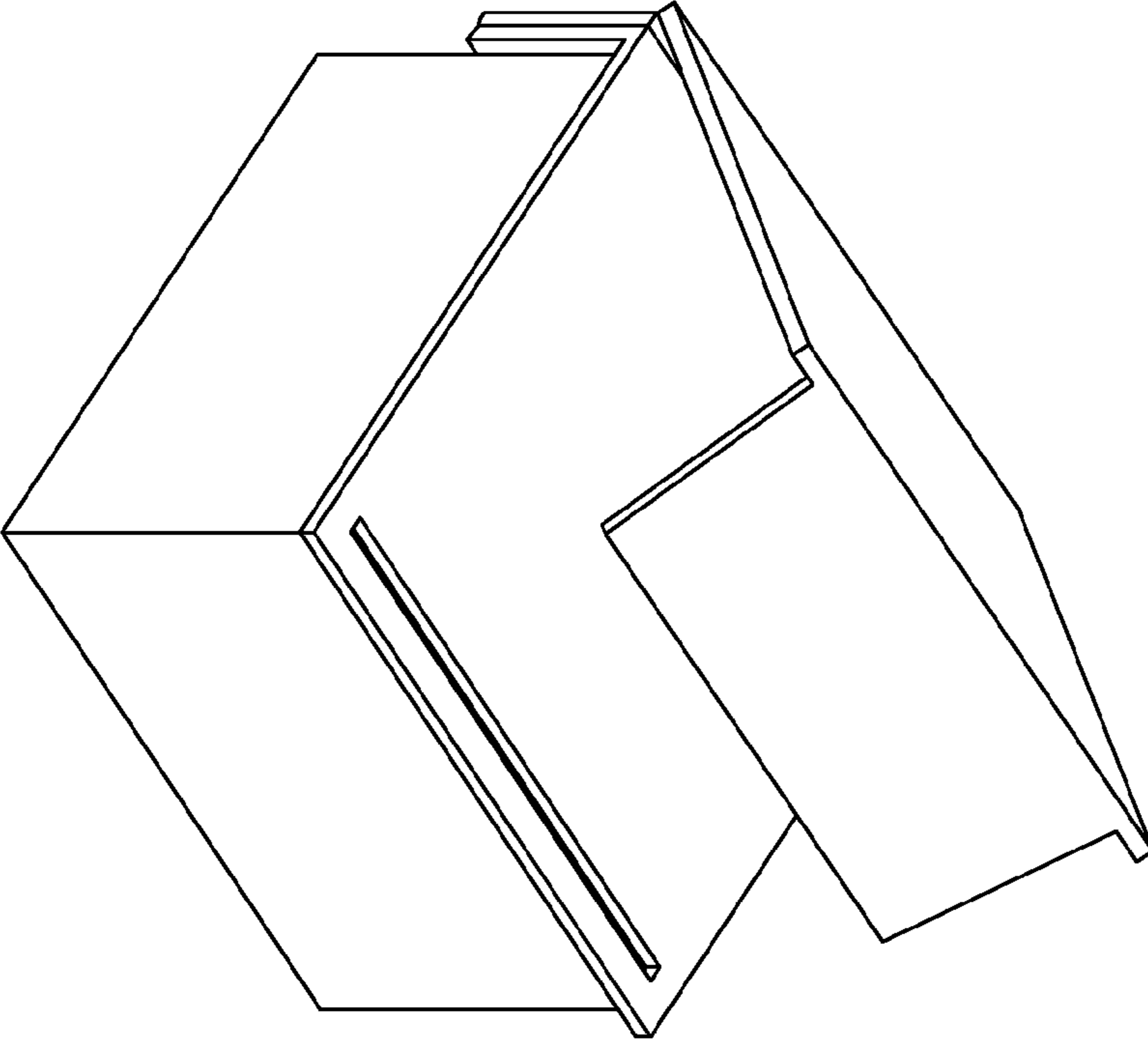

FIG. 4

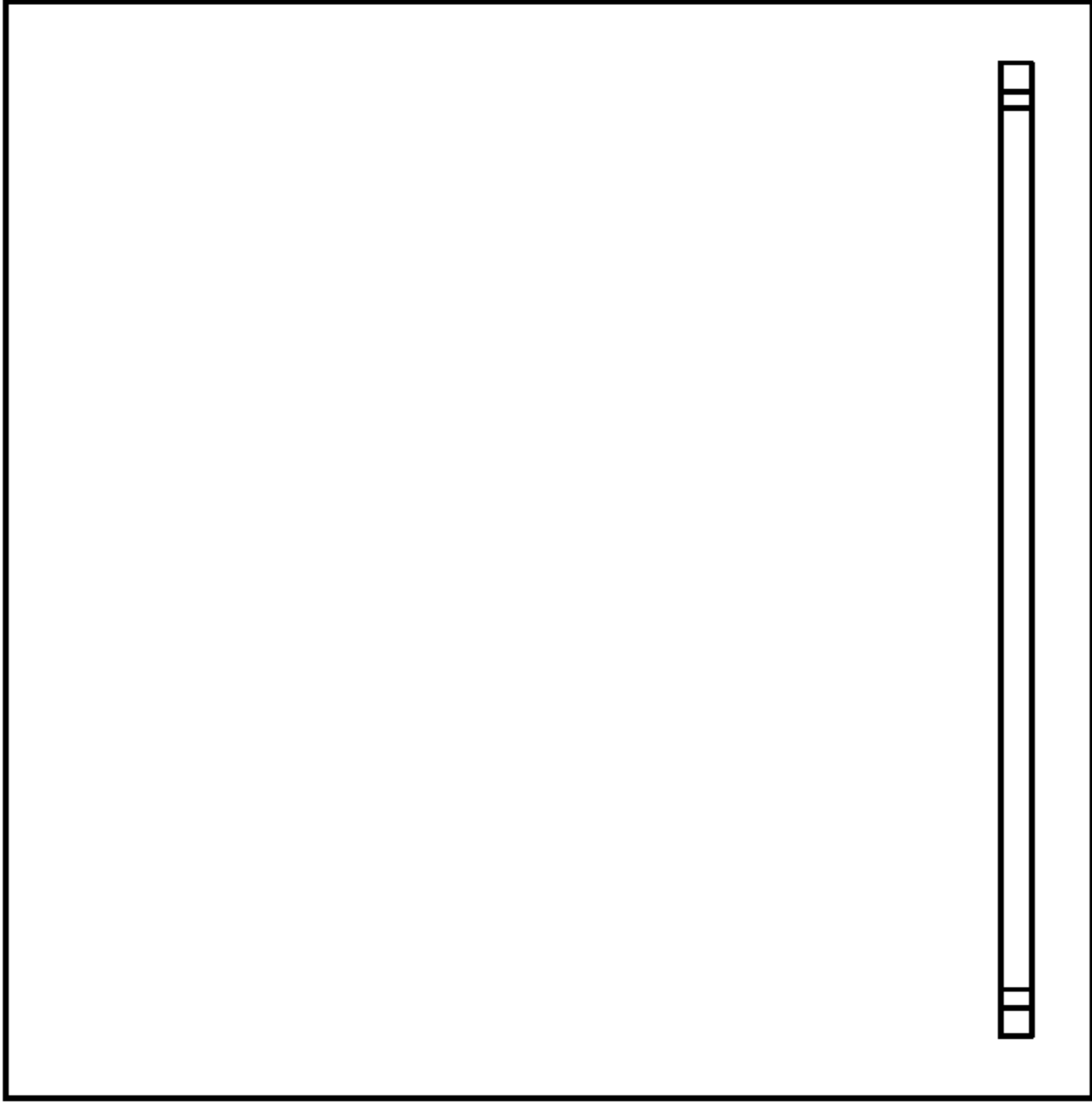

FIG. 3

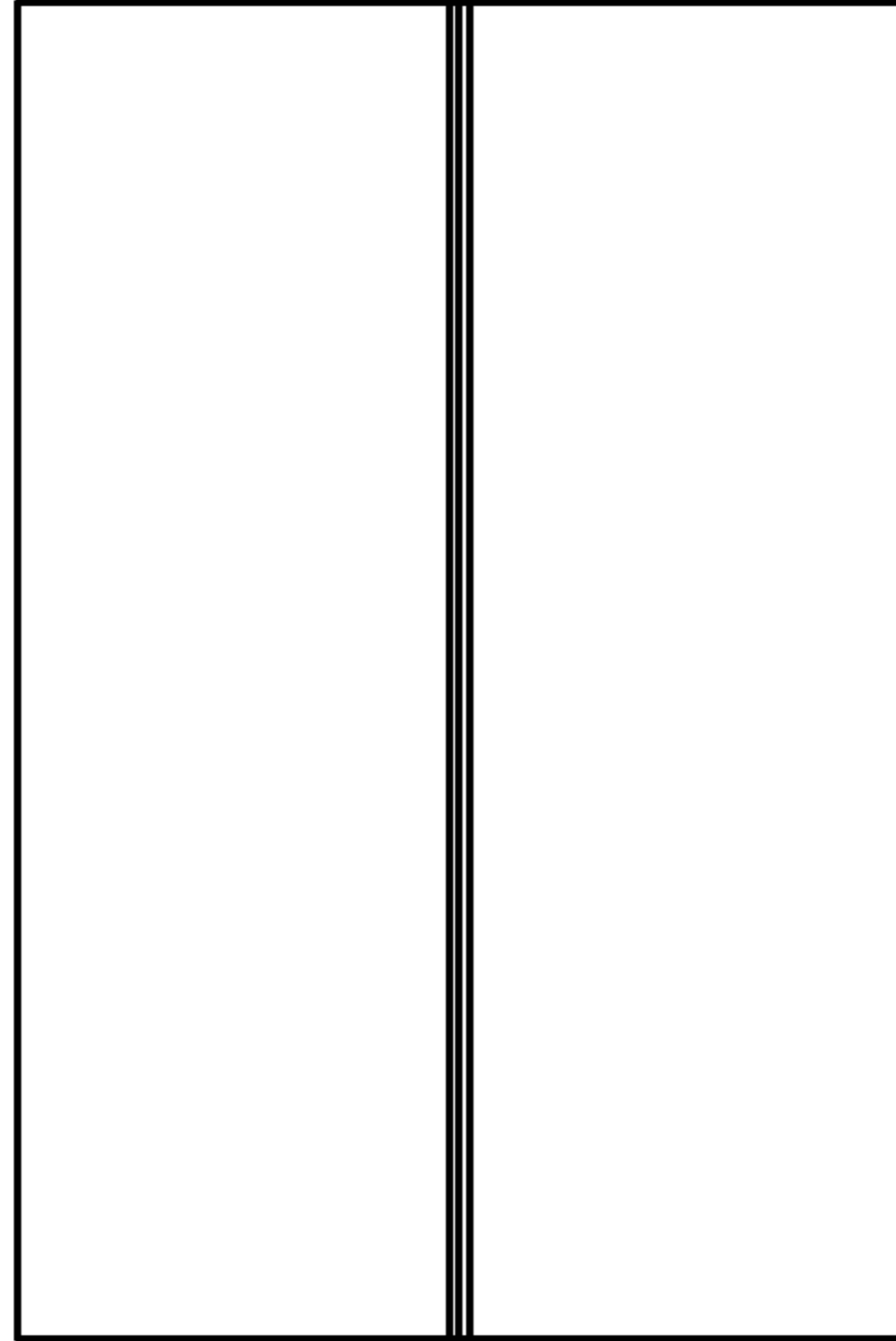

FIG. 6

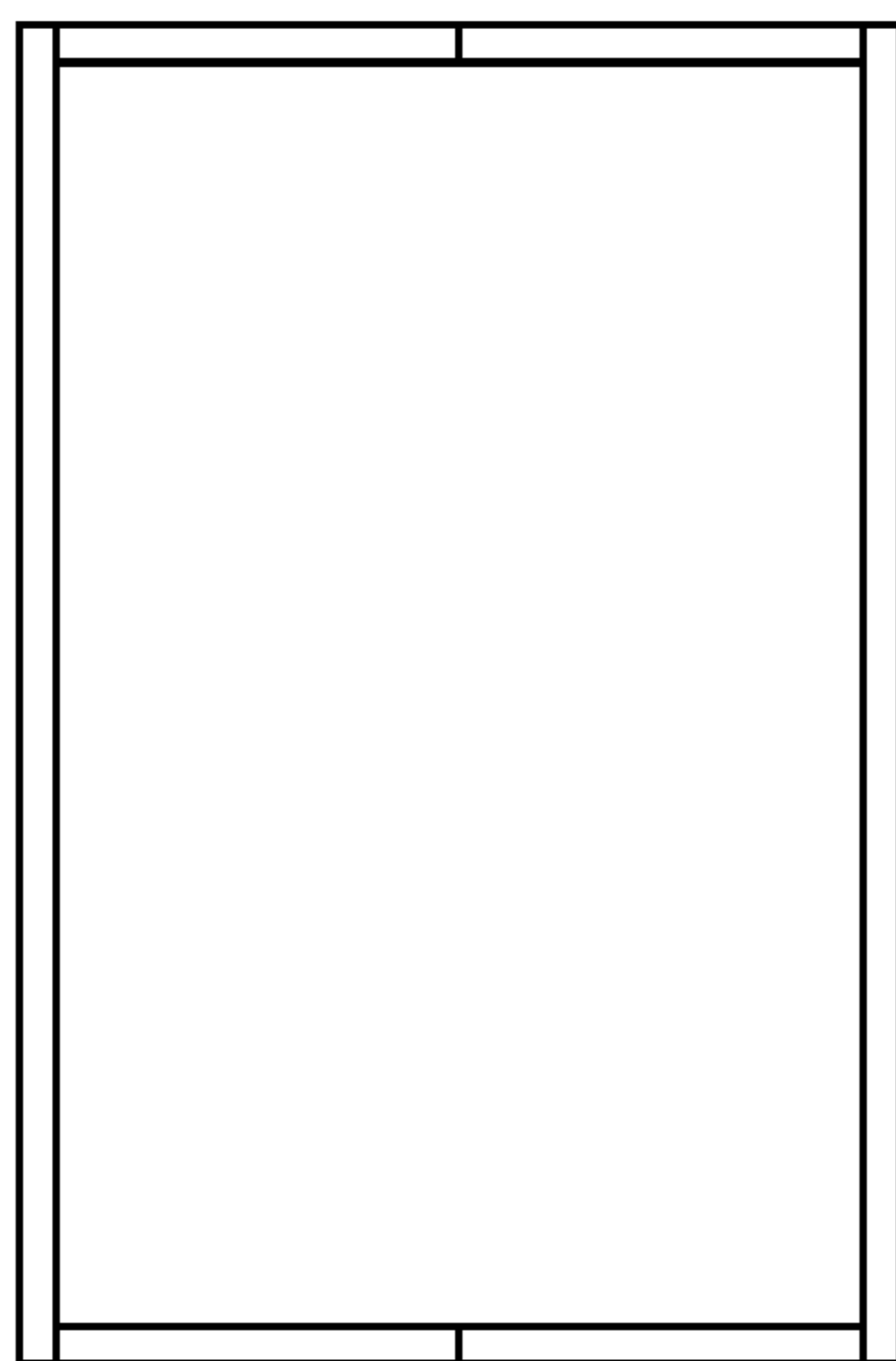

FIG. 5

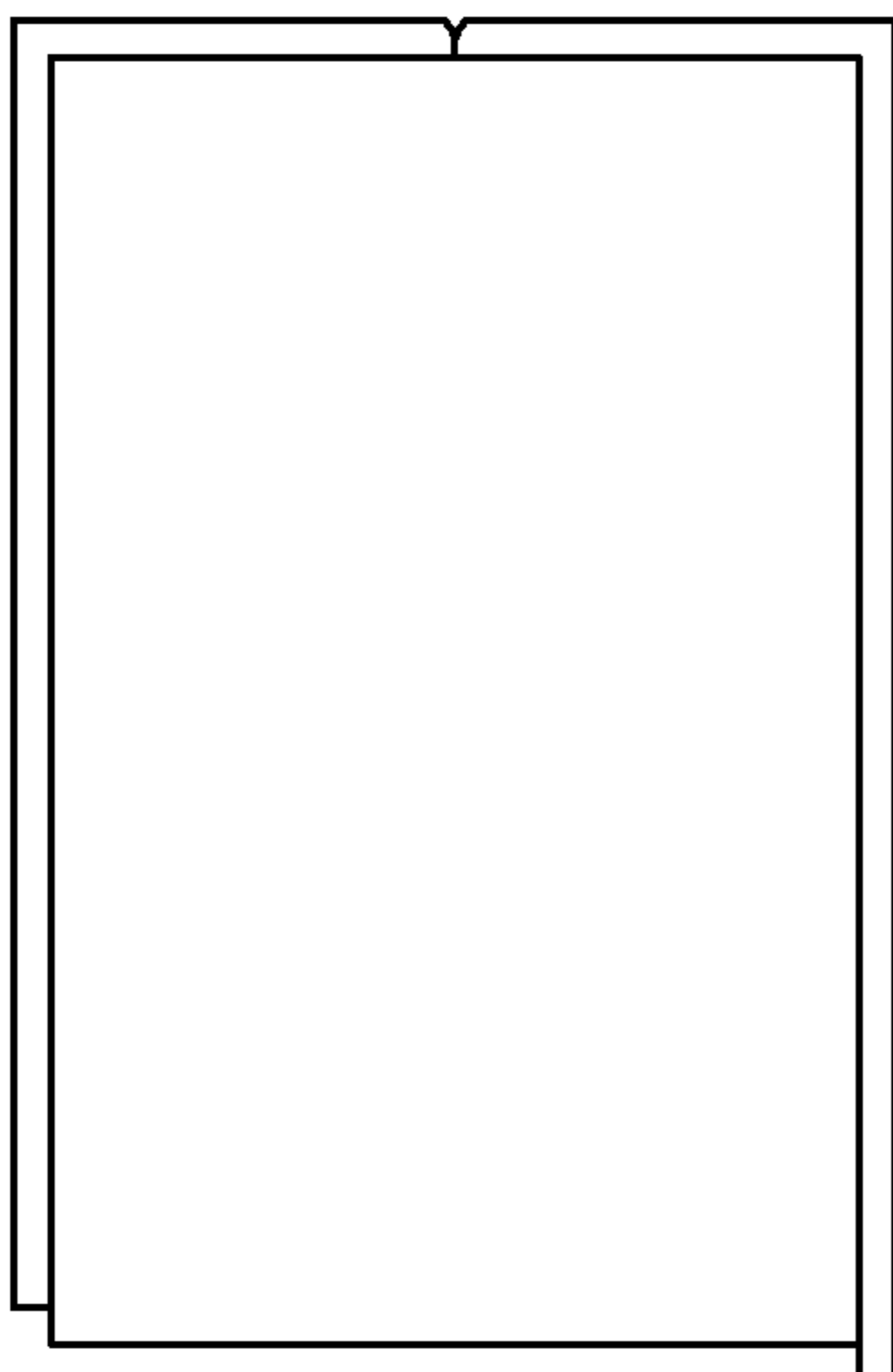

FIG. 8

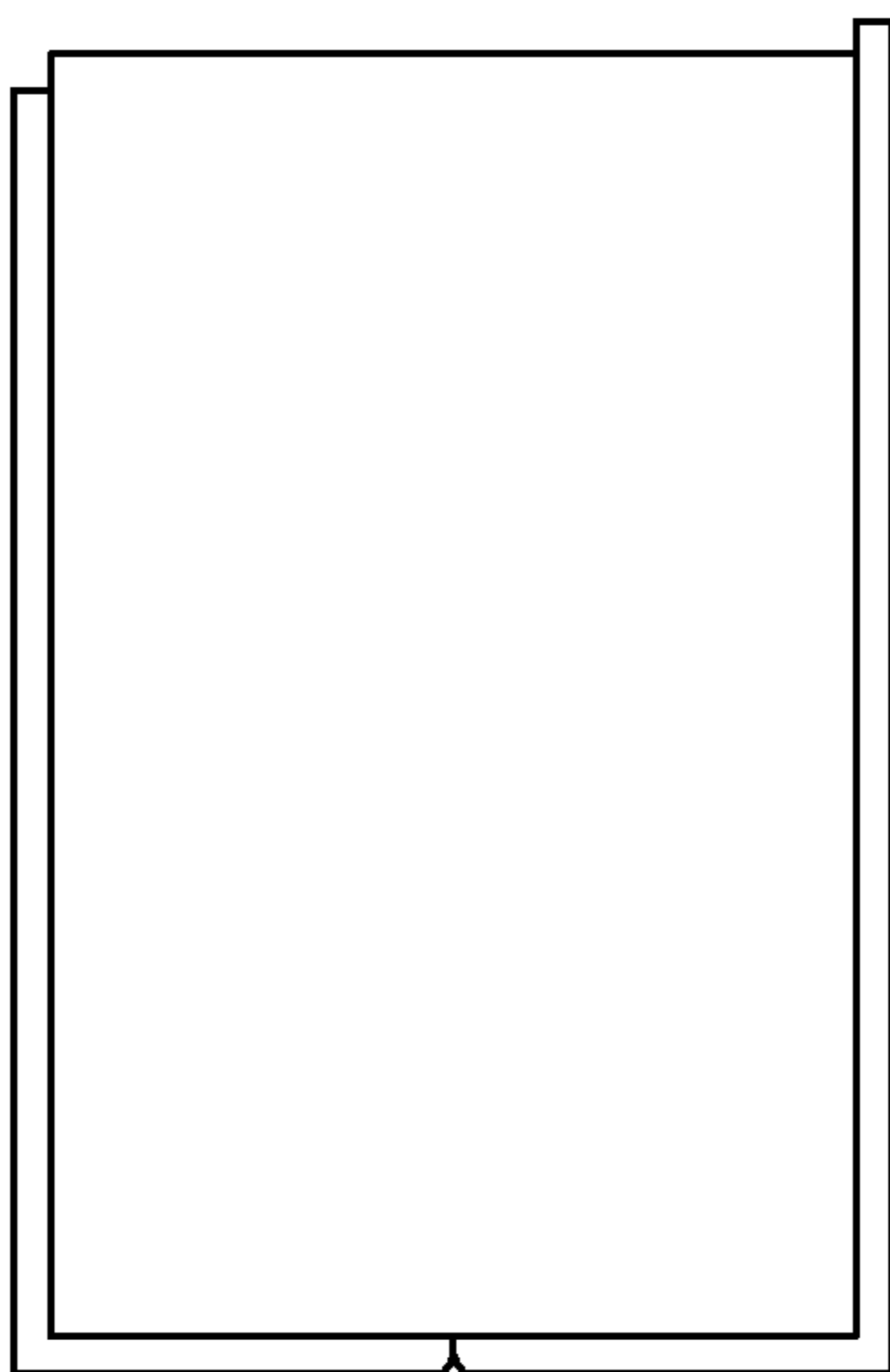

FIG. 7