



US00D606855S

(12) **United States Design Patent**
Jo et al.

(10) **Patent No.:** **US D606,855 S**
(45) **Date of Patent:** **** Dec. 29, 2009**

(54) **PACKAGING BOX**

(75) Inventors: **Kyoung-Hwan Jo**, Gumi-si (KR);
Jun-Sang Youn, Gumi-si (KR)

(73) Assignee: **Samsung Electronics Co., Ltd.**,
Suwon-Si (KR)

(**) Term: **14 Years**

(21) Appl. No.: **29/337,620**

(22) Filed: **May 27, 2009**

(30) **Foreign Application Priority Data**

Feb. 12, 2009 (KR) 30-2009-0005755

(51) **LOC (9) Cl.** **09-03**

(52) **U.S. Cl.** **D9/423**

(58) **Field of Classification Search** D9/600,
D9/667, 715, 737, 414, 420-423, 430-433;
D19/92; 206/215, 457, 485, 822; 220/890;
229/116.1-116.3

See application file for complete search history.

(56) **References Cited**

U.S. PATENT DOCUMENTS

D290,444 S * 6/1987 Osborne D9/418
D306,182 S * 2/1990 Ukisu D3/271.1
D306,185 S * 2/1990 Ukisu D3/271.1

D518,957 S * 4/2006 DeCarlo et al. D3/302
D592,968 S * 5/2009 Lee et al. D9/600
D596,025 S * 7/2009 Mordechai D9/432
2007/0209964 A1 * 9/2007 Chen 206/586
2009/0173659 A1 * 7/2009 Li 206/588

* cited by examiner

Primary Examiner—Daniel D Bui

Assistant Examiner—Thomas J Johannes

(74) *Attorney, Agent, or Firm*—Staas & Halsey LLP

(57) **CLAIM**

The ornamental design for a packaging box, as shown and described.

DESCRIPTION

FIG. 1 is a front perspective view of a packaging box;
FIG. 2 is a front view of the packaging box of FIG. 1;
FIG. 3 is a rear view of the packaging box of FIG. 1;
FIG. 4 is a left-side view of the packaging box of FIG. 1;
FIG. 5 is a right-side view of the packaging box of FIG. 1;
FIG. 6 is a top plan view of the packaging box of FIG. 1;
FIG. 7 is a bottom plan view of the packaging box of FIG. 1;
and,
FIG. 8 is a front perspective open view of the packaging box of FIG. 1.

1 Claim, 4 Drawing Sheets

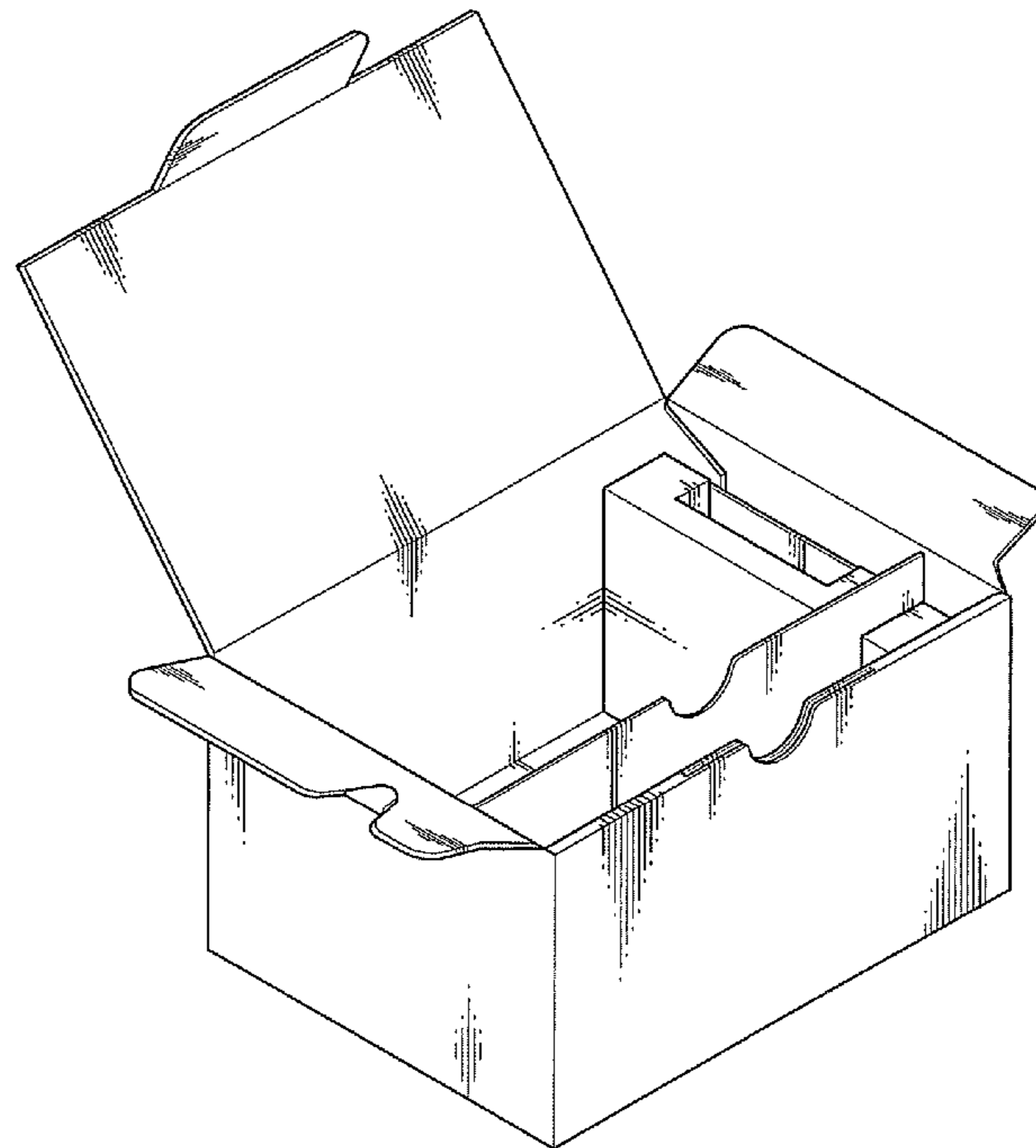
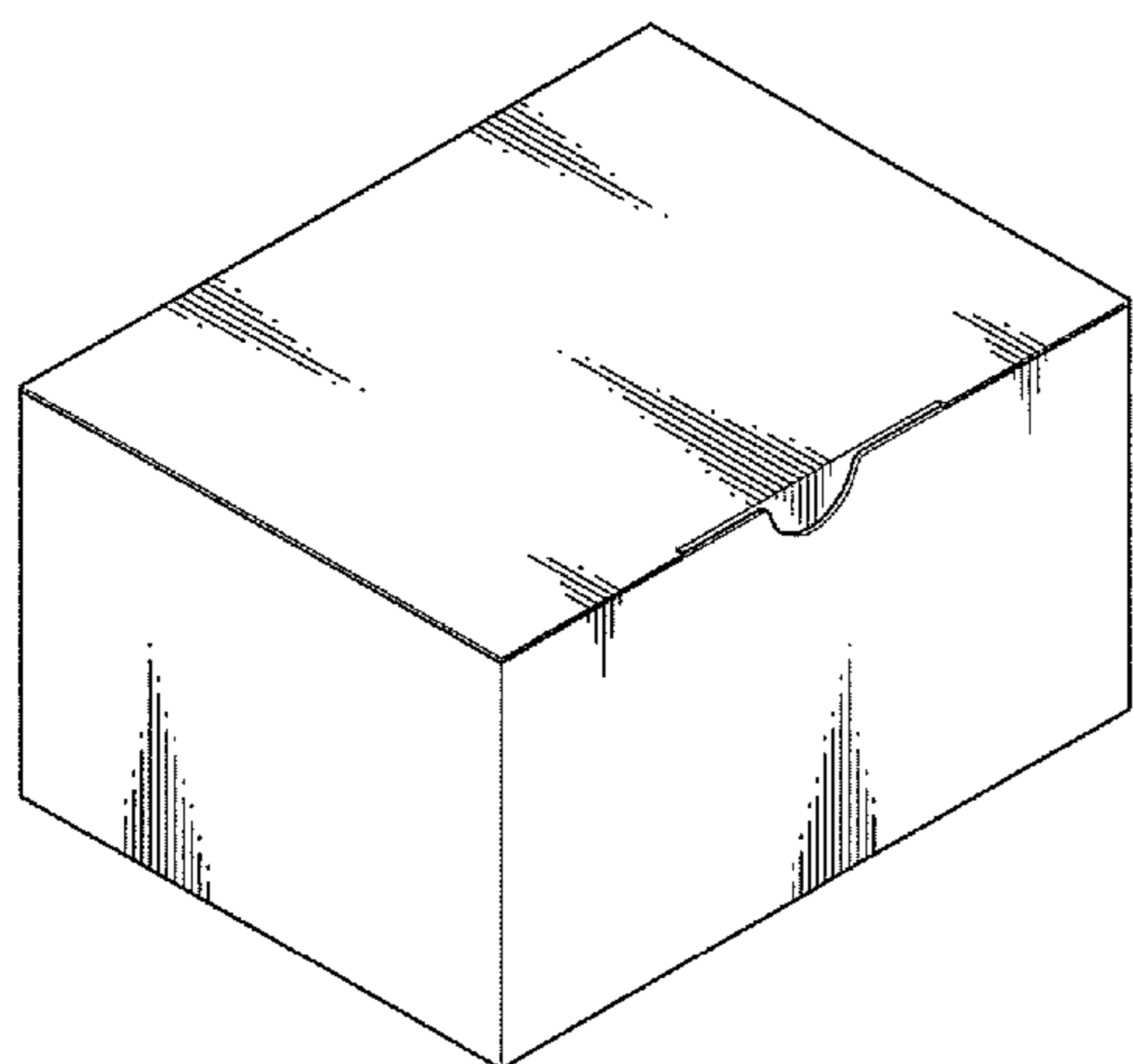

FIG. 1

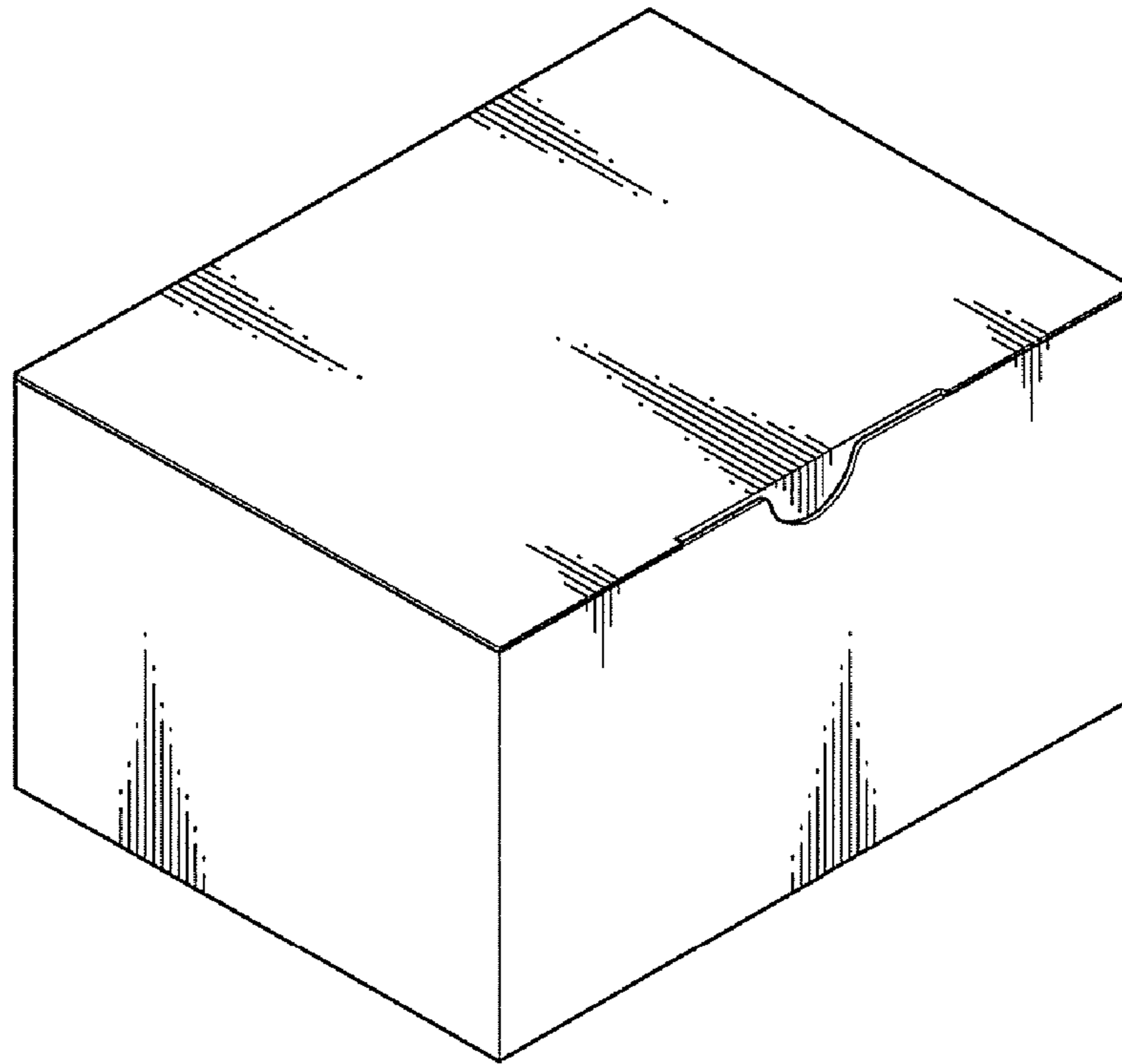

FIG.2

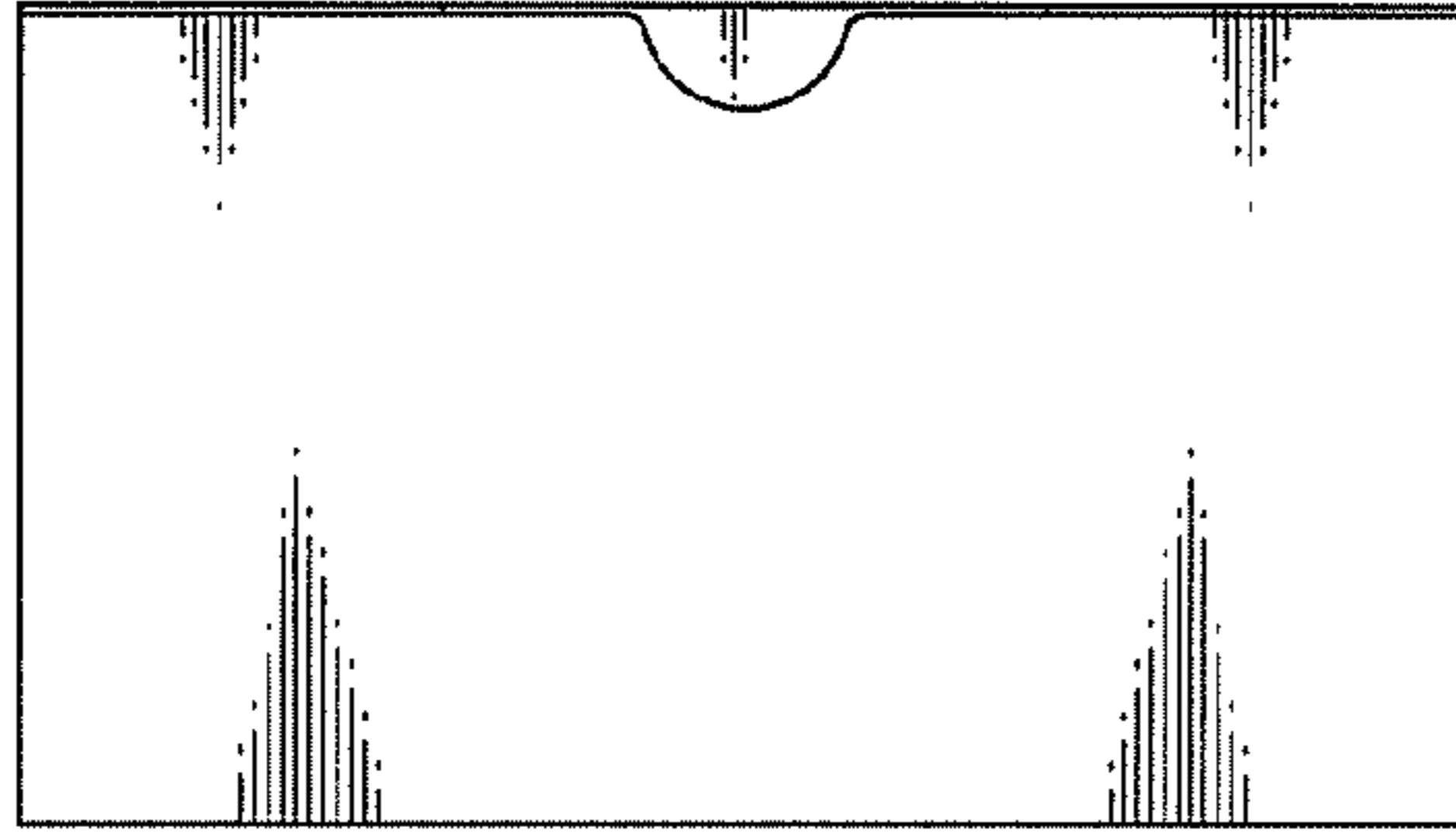

FIG.3

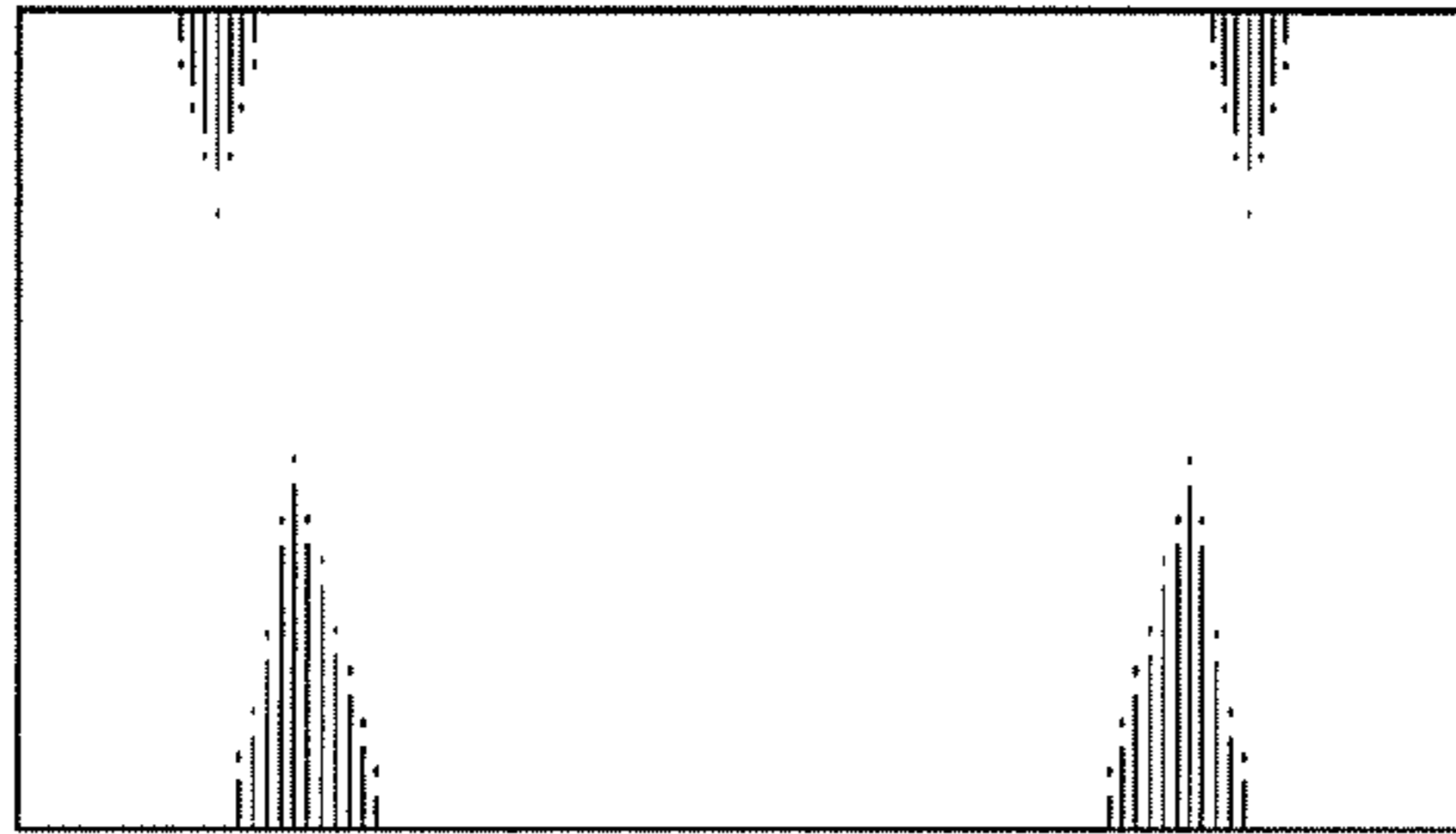

FIG.4

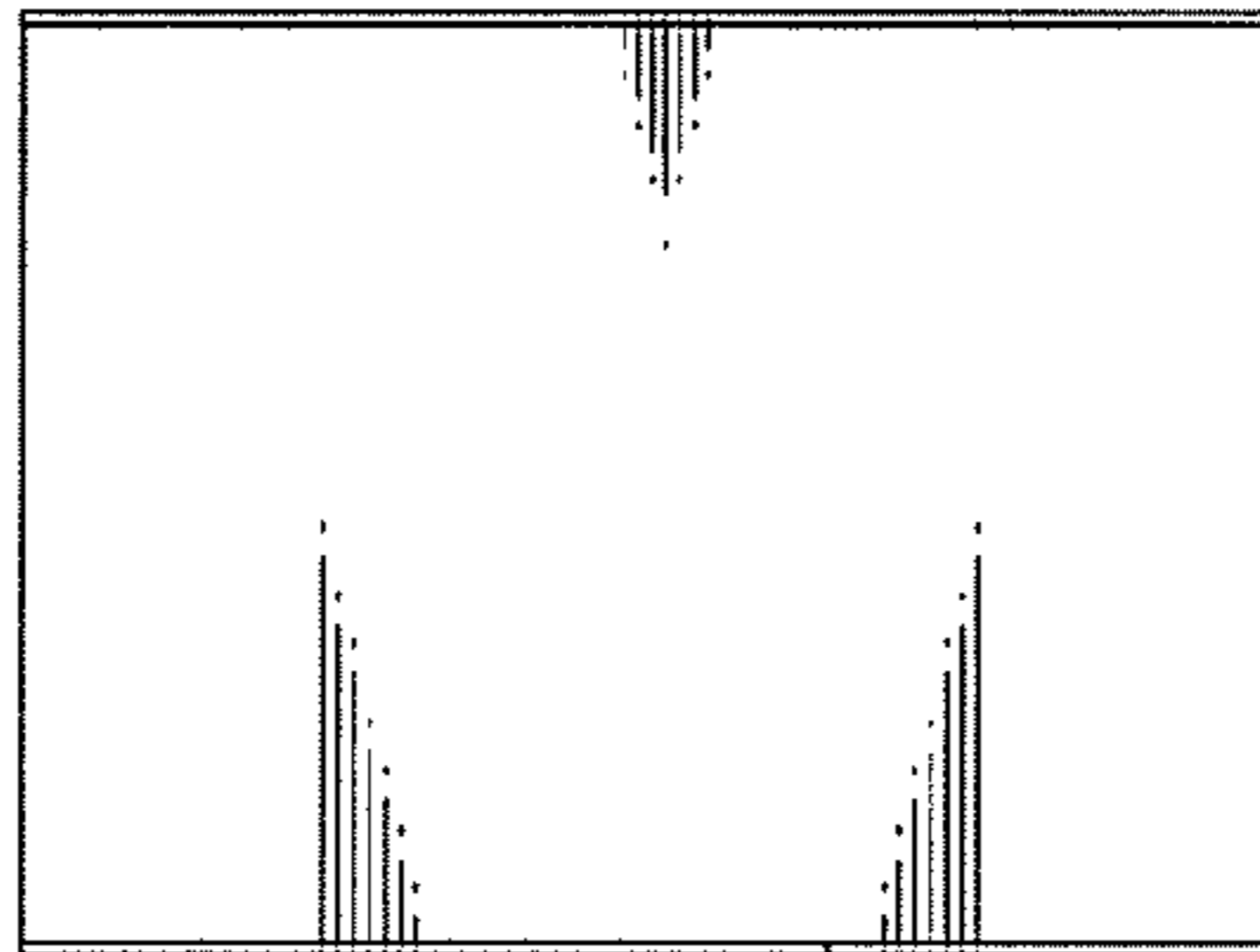

FIG.5

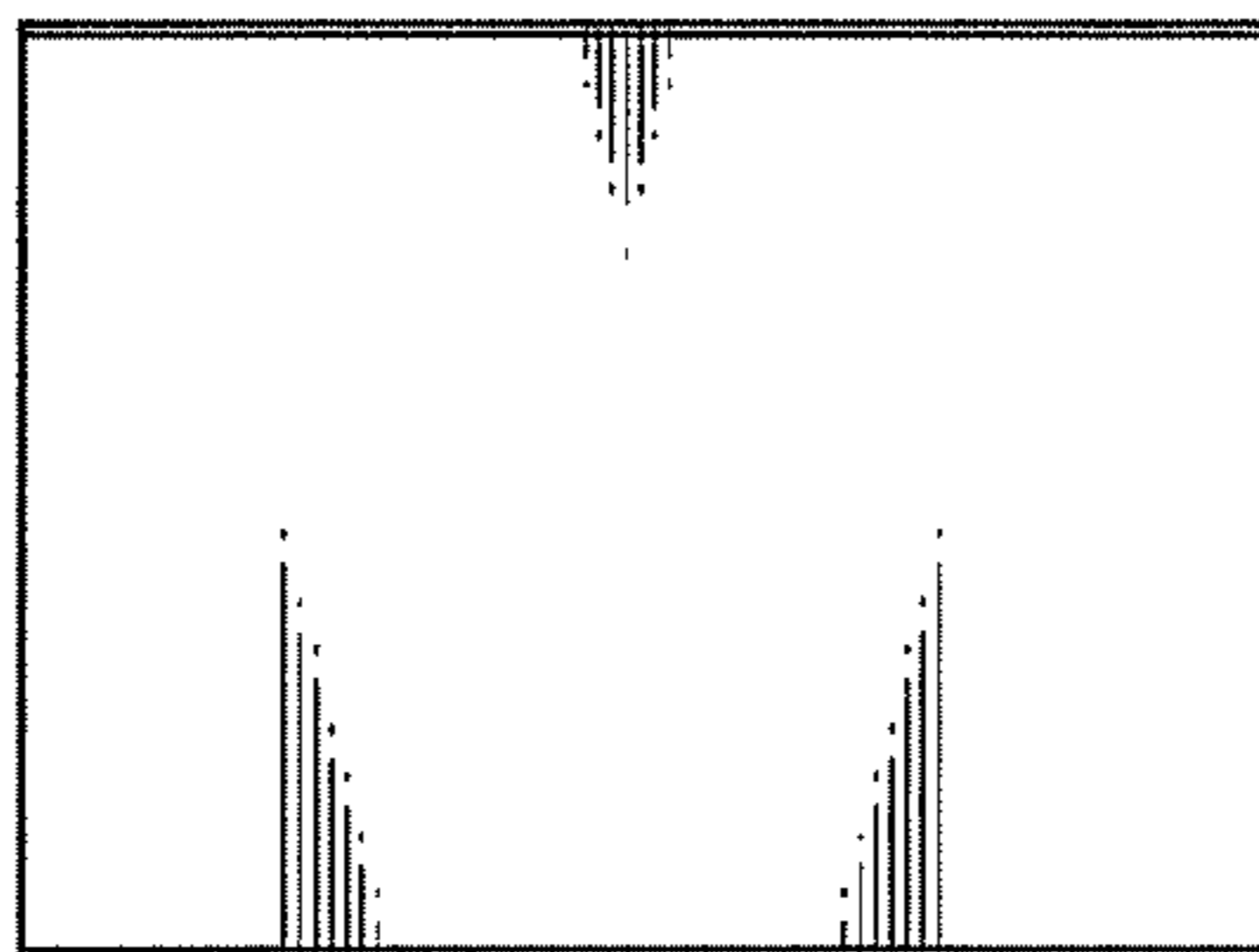

FIG. 6

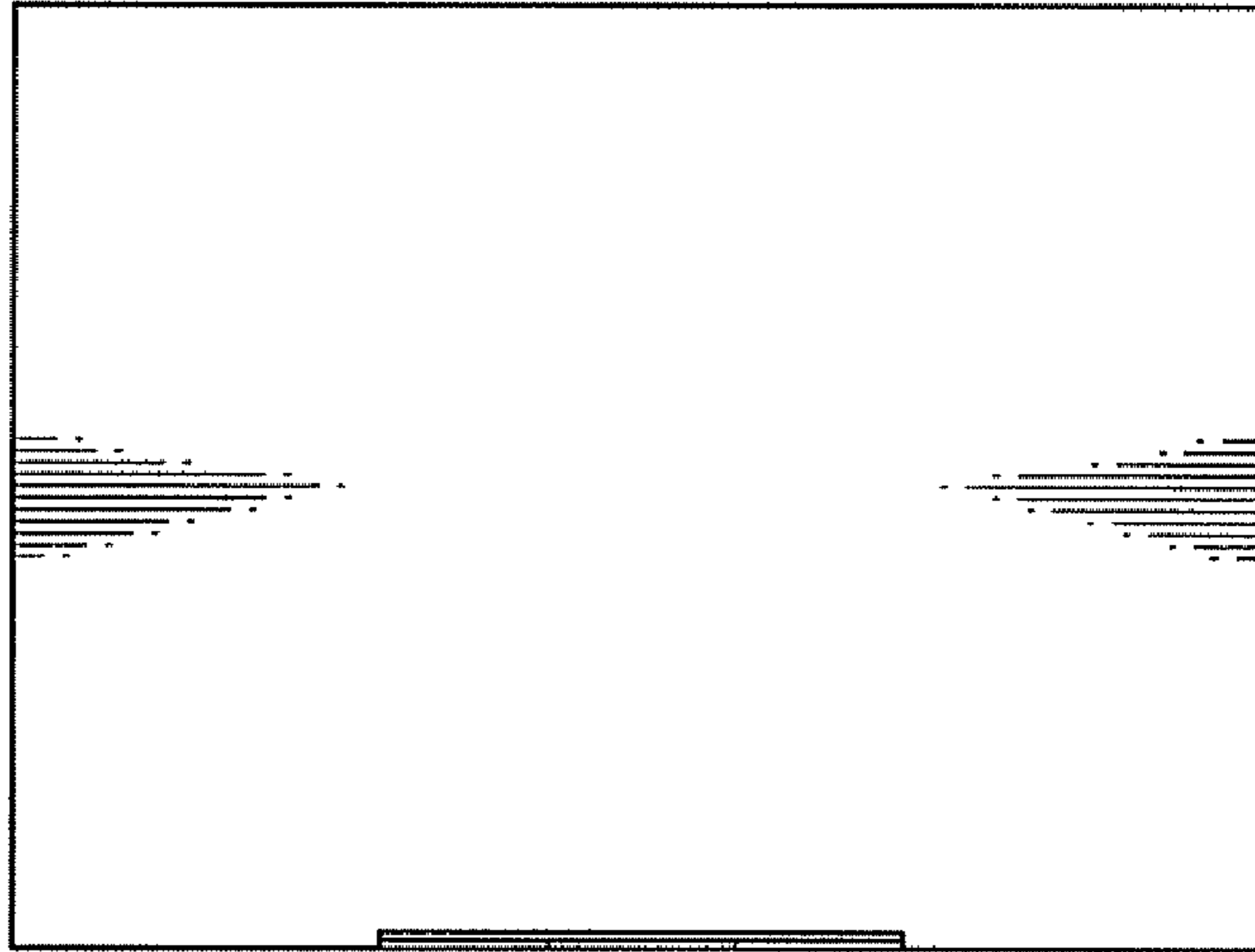

FIG. 7

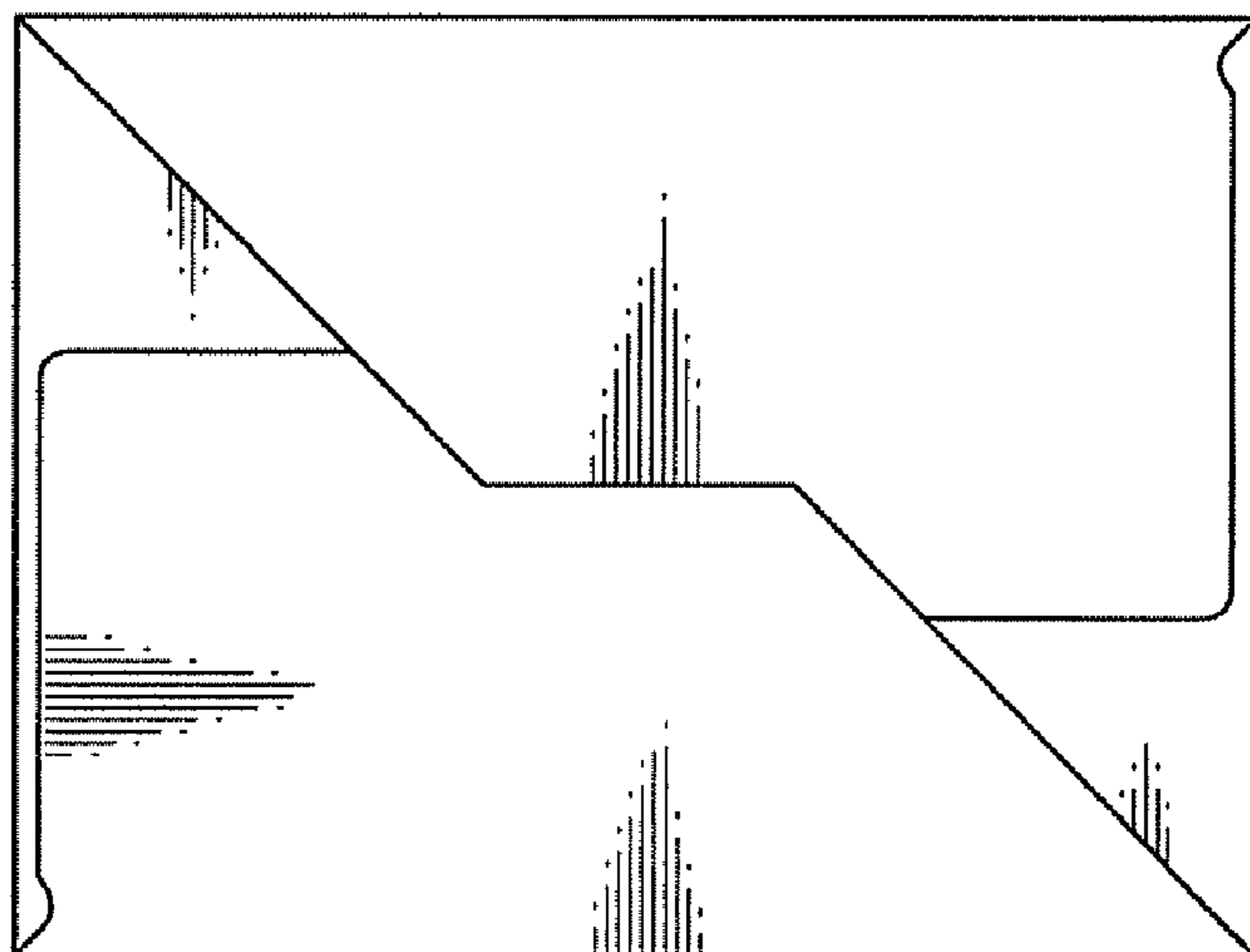

FIG. 8

